

GRP CABLE TRAY SYSTEMS

GLASS REINFORCED POLYESTER

2014

GRP

competent.
innovative.
customized.

ALL PRODUCTS
ARE CERTIFIED



Steel



- B** Steel, bare
- V** Steel, galvanized according to DIN 50 961, blued
- G** Steel, galvanized according to DIN 50 961, passivated
- S** Steel, pre-galvanized according to DIN EN 10 327
- F** Steel, hot dip galvanized after fabrication (HDGAF) according to DIN EN ISO 1461 (Replacement for DIN 50 976)
- SB** Steel, black-oxide finish
- FG** Steel, geomet® galvanized
- DV** Steel, wire galvanized
- C** **COLOR** Steel, pre-galvanized and powdercoated

C	STANDARD COLORES				SURFACE IN ALUMINIUM	
	R	W	L	WA	N	P
Complete model-No. for the colour identity	white RAL 9010 on stock	creme white RAL 9001	light grey RAL 7035	white aluminium RAL 9006	aluminium natural anodized	aluminium plate-finished

Other RALcolours on requests. For possible colour divergences we assume no liability.

Stainless Steel



- E1** Material Code.: 1.4016
- E2** Material Code.: 1.4310
- E3** Material Code.: 1.4301, 1.4303
- E4** Material Code.: 1.4401, 1.4404
- E5** Material Code.: 1.4571
- E6** Material Code.: 1.4529
- E7** Material Code.: 1.4547
- E8** Material Code.: 1.4430
- E9** Material Code.: 1.4362
- E10** Material Code.: 1.4307
- E11** Material Code.: 1.4034

- F1** Steel, zinc coating and chromate
Steel, zinc coating & chromate Thickness of zinc is between 8-12 microns, electrolytic galvanizing & additionally chromated. Corrosion resistance measured by using a salt spray test according to DIN 50021 (ASTM-B117-90) at least 72 hours.
- F2** Steel, hot dip galvanized
Thickness of zinc between 50-70 microns, after immersion machining in a bath of molten zinc.
- F3** Stainless steel (material number. 1.4401 [316])
Indoor use / Outdoor in humid environments and moderately aggressive.
- F4** Steel, coated
Dekor-lacquer interior use in dry environments and not corrosive.
- F5** Brass
For indoor use only.
- F6** Natural color
Untreated material against corrosion.
- F7** Steel, plastic coating
EVA (Ethylene Vinyl Acetate Copolymer Saponifies) Levasint® resistance to fire according to DIN 4102.
- F8** Steel, mechanical zinc plated / passivated
High quality coating. Corrosion resistance measured by means of a test salt spray according to DIN 50 021 (ASTM-B117-90) is at least 500 hours.
- F9** Steel, mechanical zinc plated / passivated
High quality coating. Corrosion resistance measured by means of a test salt spray according to DIN 50021 (ASTM-B117-90) is at least 600 hours.
- F10** Steel, electrical mechanical / passivated
Zinc coating thickness of 5 microns, electrolytically applied and clear passivated according to BS EN 12329 2000 FE/ZN5//A.



- AL** Aluminium (N = naturally anodized, * = powdercoated in RAL colors)
- P** Electrotechnical Porcelain
- MS** Brass
- CU** Copper

Plastics

- K01** PA - Polyamide, non halogen
- K02** PS - Polystyrene, non halogen, impact resistant
- K03** PE - Polyethylene, non halogen
- K04** PP - Polypropylene, non halogen
- K05** PC - Polycarbonate, non halogen
- K06** SBR/NBR - Styrene-Butadiene/Nitrile Rubber
- K07** CR - Chloroprene Rubber
- K08** NBR - Nitrile Rubber
- K09** PVC hard - Hard Polyvinylchloride
- K10** PVC - Polyvinylchloride
- K11** ABS - Acrylonitrile-Butadiene-Styrene
- K12** ASA - Acrylate-Styrol-Acrylonitrile Copolymer
- K13** PC/ABS - Polycarbonate/Acrylonitrile-Butadiene-Styrene
- K14** POM - Polyacetal
- K15** SBR - Styrene-Butadiene Rubber
- K16** CR/NBR - Chloroprene/Nitrile Rubber
- K17** CR/SBR - Chloroprene/Styrene-Butadiene Rubber
- K18** TPE - Thermoplastic Elastomer
- K19** FS 31 - Phenolic Resin
- K20** SI - Silicone Rubber
- K21** PUR - Polyurethane
- K22** PET - Polyethylene Terephthalate, halogen free
- K23** GRP - Glass-Fiber Reinforced Polyester, halogen free
- C1** Epoxy Coating

- New
- Info
- Installation Instructions
- Reference Note
- Hardware
- Fast Install
- Siderail Height in mm
- Wire Diameter in mm
- Cover hole and depth in mm
- Pipe Diameter in mm
- Discontinued model
- No halogen
- No silicone

Please ask for the Certifications VDE/UL

All products in this catalog are classified according to the EAN code (13 digits). The first 7 digits indicate the country (40 = Germany) and the manufacturer's code (13339 = Niedax). The following six digits are the product code. example EAN code of the product TK = 40 60.85 13339 183708.

Important notice: The information herein has been carefully checked for accuracy and is believed to be correct and current. No warranty, either expressed or implied, is made as to either its applicability to or its compatibility with specific requirements of this information, nor for damages consequential to its use. All design characteristics, specifications, tolerances and similar information are subject to change without notice.

Ebo Systems, always ahead...

Founded in 1959 in Switzerland (Zurich), EBO Systems was one of the first companies in Europe to specialise in the design and manufacturing of profiles for the support and installation of electric cables.

In 1972, a new production facility, specialised in the production of cable management systems, was set up at Villers-La-Montagne in France, in order to face up the increasing demand from different markets.

Since 1980 EBO Systems continues to invest and evolves to provide the best solution for the market, in addition to the hot press moulding technique, EBO Systems introduced the pultrusion technique and become the only manufacturer to supply to the customer two ranges of products.

To expand its range of products it develops and standardizes a new mix halogen-free and self-extinguishing which generates very little smoke in case of fire hazard.

Always at the forefront of new technologies Ebo Systems invests in an automated production of hot press moulding to reduce manufacturing lead times, increase quality and get the most competitive prices. With always the same goal: the customer satisfaction.

Ebo Systems joined in 2010 the German Niedax Group, one of the leading specialists in steel cables trays, thus strengthening its international presence.



Projets...



Ebo Systems are tools of advanced production technology, combined with human expertise to over 50 years ...

From Paris to Singapore via Dubai, EBO Systems is present in more than 27 countries becoming the global supplier of your projects in energy, transport and industrial building.



But it is also ...



An efficient customer service with a unique contact who takes in consideration the customers requests, needs, specifications for your national and international projects.



A Research & Development department Able to give advices and propose personal study upstream, during and after your project, and provide a technical assistance on-site.



A logistics department with a good experience of deliveries around the world.



Respect for the environment Ebo Systems engages in environmental quality certification Iso 14001 and proceeds to products recycling.



Cable tray systems in Glass Reinforced Polyester

are characterized by their extreme resistance because no other material is as strong as fiberglass reinforced polyester. In extreme conditions such as heat, sunlight (UV), cold or exposure to chemicals, material performs its function and for many years.

Qualities and advantages

High temperature resistance (-80 ° C à +130 ° C)

- high mechanical resistance
- high chemical resistance
- high dielectric strength
- Corrosion resistance
- extremely insulating material
- halogen free
- UV resistance
- food security
- low weight
- low thermal conductivity
- simple and without burr when changes
- extraordinary long lifetime
- self-extinguishing material
- no electrolytic corrosion
- no need to earth
- without toxic fumes
- optimal transportation and handling

The support systems of glass fiber cables offer maximum flexibility and efficiency. The wide range of products can meet the different applications of cables trays systems. A full range of standard fittings allows easy many configurations. Special sizes are available on demand.

Ebo has been certified since 1994 according to ISO 9001.
What does this mean for you as a client:



- Ongoing evaluation and classification of suppliers
- The systematic control of raw materials and semi-finished goods receipt
- A regular review of technical data of materials in the laboratory
- Perfect control of the manufacturing
- Monitoring of the manufacturing process
- final inspection before shipment

Other certifications are available on our web site: www.ebo-systems.com

SYSTEMS OVERVIEW

Cable tray systems **K²** K23 Available in widths 50 - 600 mm

- mechanical resistance thanks to a mixture of special resin
- made of pressed polyester reinforced with fiberglass
- Interlocking and self-adjustable coupling, no screws required
- 19 dimensions of cable trays available from stock perforated or not perforated
- 188 fittings available
- supporting distance of maximum 1,5 m

Application areas

wastewater treatment plant, chemical, offshore, tunnels, solar and photovoltaic installations, industrial facilities, power plants, mines, farms and food production.

Cable tray systems **KP** K23 Available in widths 60 - 300 mm

- made of pultruded polyester reinforced with fiberglass
- Quick assembly with clip in jointing pieces
- Expansion joint automatically set
- Cable trays with or without perforations
- Fast fix clip on lids
- supporting distance of maximum 4 m

Application areas

wastewater treatment plant, chemical, offshore, tunnels, solar and photovoltaic installations, industrial facilities, power plants, mines, farms and food production.

Cable ladder systems **UL** K23 Available in widths 150 - 900 mm

- made of pultruded polyester reinforced with fiberglass
- 30 dimensions of cable ladders available from stock perforated or not perforated
- Delivered assembled
- Possibility of on-site assembly, significant reduction in transport costs
- Unique patented clip-in rungs assembly, without metallic or thermoplastic parts
- No risk to damage cables when pulling them into the ladders
- Better resistance to vibrations
- Reversed rungs available
- Fittings available in all dimensions
- Supporting distance of maximum 6 m

Application areas

wastewater treatment plant, chemical, offshore, tunnels, solar and photovoltaic installations, industrial facilities, power plants, mines, farms and food production.

Trunking system LFG K23 40 50 80 Available in widths 57 - 300 mm

- made in pultruded polyester reinforced with fiberglass
- 8 dimensions available
- maintenance of cables through a system of clamps
- extremely resistant

Application areas

among others: water treatment plants, sewage farms and food production, refineries, oil & gas platforms, Off Shore, solar and photovoltaic installation, Tunnel

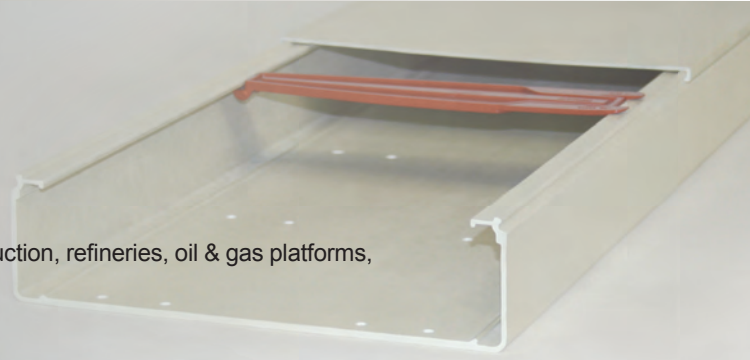

Ground ducts Press moulded GRP BK/BKS K23 140 155 176 191 Available in widths 200 - 400 mm

- made in pressed polyester reinforced with fiberglass
- Interlocking and self-adjustable coupling, no screws required
- Anchor attachment in concrete pre-mounted
- Extremely impact and frost-resistant

Application areas

among others: business bridge construction, tunnel, mining and port facilities.



Stand-System SP K23 150 Available in widths 150 und 250 mm

- made in pultruded polyester reinforced with fiberglass
- insulating, no need to earth
- slight
- resistant short circuit of 30 kV, certificate provided by IPH Berlin

Application areas

among others: railways, trains, subways

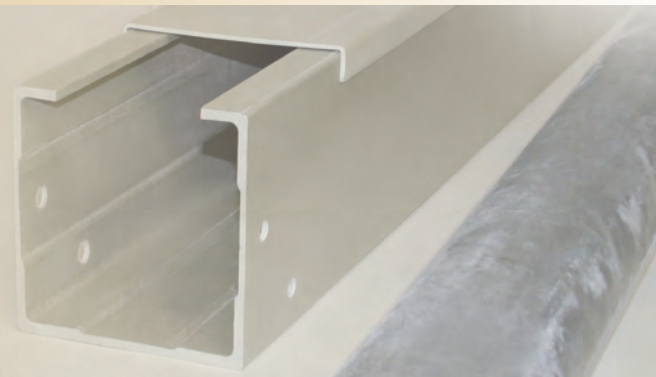

Cable tray handrail systems MC K23

- made in pultruded polyester reinforced with fiberglass
- fire retardant
- self-extinguishing material
- low thermal conductivity
- maximal supporting distance 1.5m
- certified E30, conform to the standard DIN 4105-12

Application areas

among others: industrial plants railways, and road tunnels



NOTES

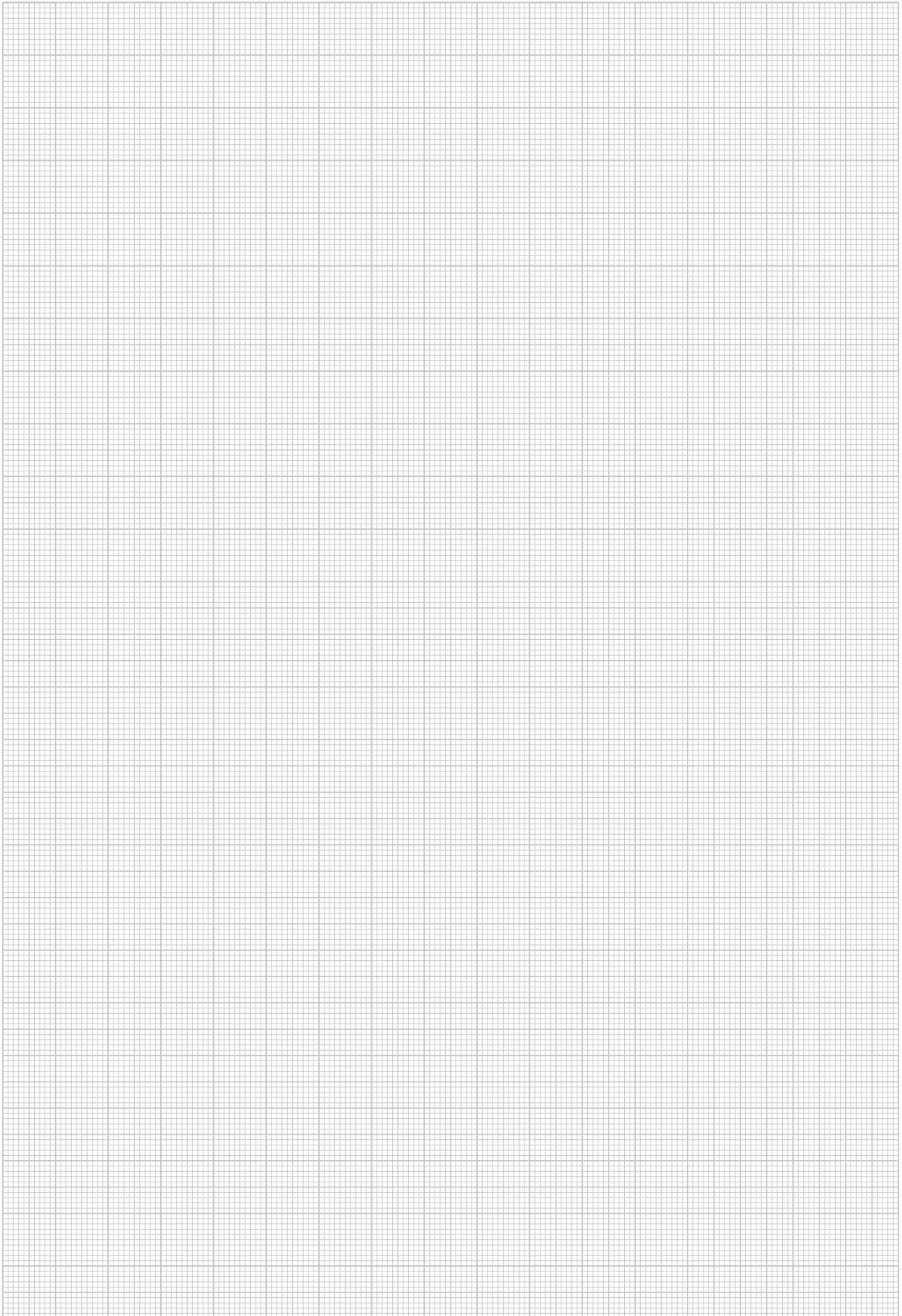

Alphabetical table of contents

Type listing

page 6
page 8-12

Support system

- Support and bracket
- Bracket
- Profil
- Fixing plates

TK

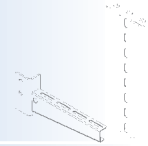

Cable tray system K²

- Cable trays
- Separators
- Fittings
- Covers
- Accessoires

K²

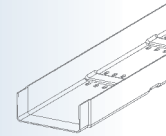

Cable tray system KP

- Cable trays
- Separators
- Fittings
- Covers
- Accessoires

KP

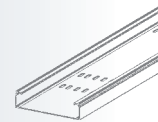

Cable ladder system UL

- Cable ladders
- Separators
- Fittings
- Covers
- Accessoires

UL

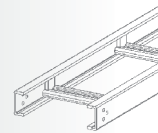

Trunking system LFG

- Wall mounted cable tray
- Separators
- Fittings

LFG

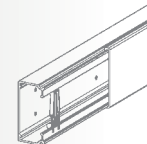

Ground ducts BK/BKS

- Cable trays
- Separators
- Covers
- Accessoires

BK/BKS

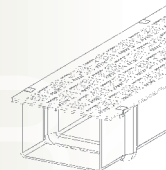

Cable troughing SP

Long span aerial cable trays

SP

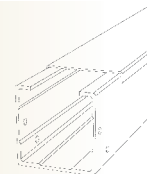

Handrail system MC

- Handrail profil
- End fittings
- Accessories

MC

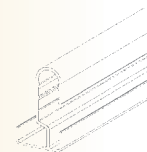

Information

- Thermoset resins
- Plastic
- Zinc plating technique

INFO 

TABLE OF CONTENTS IN ALPHABETICAL ORDER

A

Anchor bolt	24
Anchor fixing plate included bolts	23

B

Bolt	98
------	----

C

Cable tray for a ground installation	111
Ceiling support	20, 24
Ceiling support and wall bracket	17
Ceiling support profile	21-22
Clipsable handrail end cap	124
Clipsable splice plate	59, 63, 103, 126
Cover fixing	50, 69, 97, 99, 110-111
Cover fixing clip	50-51, 69, 96, 110
Cover for cable ground duct	110
Cover for cable trays and cable ladders	46, 94
Cover for horizontal elbow 90°	94
Cover for horizontal elbow 90°, large radius	46, 66
Cover for horizontal elbow 90°, small radius	47

D

Dome head bolt	52, 70, 98
----------------	------------

E

End cap for cable tray	59, 63, 104
End cap for GRP cable ladder	76, 80, 84, 89
End cap for GRP cable tray	30, 35, 40
End cap, (clippable)	126

F

Fork-type self-locking plier	99
------------------------------	----

G

GRP adjustable elbow	78, 82, 87, 92
GRP adjustable splice plate	31, 35, 40
GRP bracket	18-19
GRP cable ladders	76, 80, 84, 89
GRP cable trays	30, 35, 40, 58, 62
GRP changing elevation	33, 38, 43, 60, 64
GRP cover for cable tray	66
GRP cover for changing elevation	48-49, 67-68
GRP cover for cross	96
GRP cover for horizontal elbow 45°, small radius	46, 66
GRP cover for left hand reduction	50, 69
GRP cover for right hand reduction	50, 68
GRP cover for tee junction	96
GRP cover for tee junction, large radius	49, 68
GRP cover for vertical adjustable elbow	94-95
GRP cover for vertical inside elbow	47, 66-67
GRP cover for vertical outside elbow	48, 67
GRP cross for cable ladder	77, 81, 86, 91
GRP elbow 45°, small radius	60, 63
GRP elbow 90°	78, 82, 86, 91
GRP elbow 90°, large radius	60, 64
GRP fixing rail	25
GRP ground duct	109
GRP horizontal splice plate	76, 80, 85, 90
GRP left hand reduction	32, 38, 42
GRP right hand reduction	32, 37, 42
GRP separator	31, 36, 41, 77, 81, 85, 90, 104, 109
GRP support	19

G

GRP tee junction cable ladder	77, 81, 85, 90
GRP tee junction for cable tray, large radius	31, 36, 41, 63
GRP tee junction for cable tray, small radius	31, 36
GRP tee junction, small radius	59
GRP trunking	103
GRP vertical adjustable or vertical fixed angle splice plate	79, 83, 92
GRP vertical adjustable or with fixed angle splice plate	87
GRP vertical inside elbow	33, 39, 43, 60, 64
GRP vertical outside elbow	34, 39, 43, 61, 64
GRP vertical splice plate	33, 38, 42

H

Handrail	123-124, 126
Handrail end cap	123
Hanger	21
Hanger and wall bracket	17
Hexagon head bolt	52, 70, 98
Hold down clamp for cables	103
Hold down clamp for cables E30	125
Horizontal elbow 45°	32, 37, 41
Horizontal elbow 90°	105
Horizontal elbow 90°, large radius	32, 37, 42
Horizontal elbow 90°, small radius	32, 37, 41
Horizontal splice plate	31, 36, 41
Horizontal stainless steel splice plate	77, 81, 85, 90

L

Ladder fixing hold down clamp	98
Lighting support	125

M

Mounting plate	34, 39, 44
----------------	------------

P

Polyamid bolt	123
Profile U 5050	22-23
Protective end cap	18, 21

R

Rack for cables	70
Reducer	78, 82, 87, 92
Riveted handrail end cap	124

S

Separating stud	52, 70
Separator	59, 63
Splice plate	59, 123
Stainless steel vertical splice plate V4A	33, 38, 42
Steel cover for cable tray	111
Steel tape for cover	97

T

Tee junction cover, small radius	49, 68
The half end cap must be clipped	125
The half end cap must be riveted	124

V

Vertical inside elbow 90°	104
Vertical outside elbow 90°	104
Vertical splice plate	79, 83, 88, 93

W

Wall-mounted angle plate	96, 99, 123
Wall-mounted angle plate E30	126

NOTES

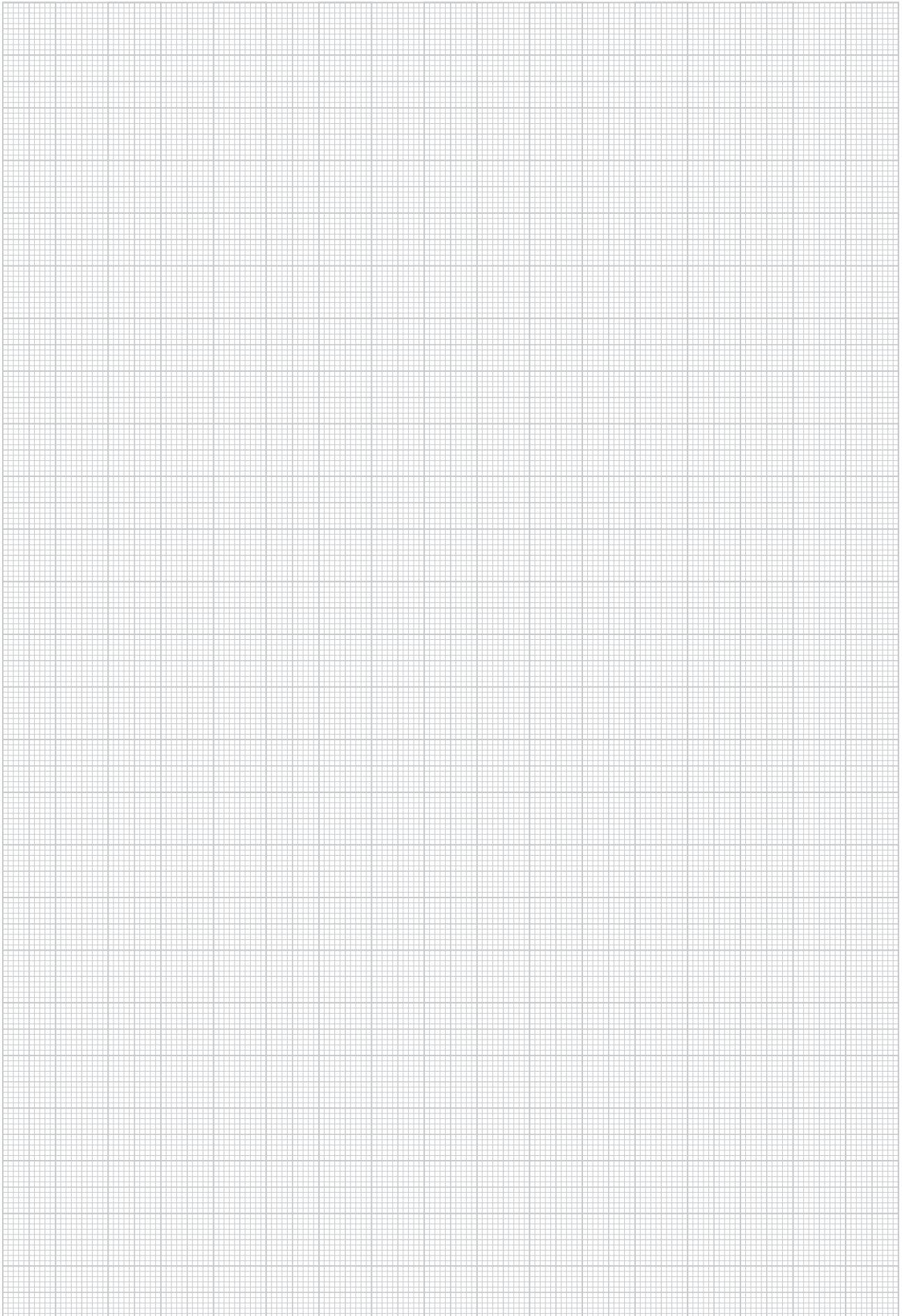

LIST OF ITEMS

model no.	EAN code	Page	model no.	EAN code	Page	model no.	EAN code	Page
BK 140.200	952991	109	FPAM 200	955862	18	KK 80.150	952076	35
BK 176.300	953004	109	FPAM 300	955879	18	KK 80.200	952083	35
BK 176.400	953011	109	FPAP 100/AC	955725	18	KK 80.250	952090	35
BKDR 200	956029	110	FPAP 150/AC	955732	18	KK 80.300	952106	35
BKDR 200-5 F	956043	111	FPAP 200/AC	955749	18	KK 80.400	952113	35
BKDR 200-8 F	956074	111	FPAP 250/AC	955756	18	KK 80.500	952120	35
BKDR 300	956036	110	FPAP 300/AC	955763	18	KK 80.600	952137	35
BKDR 300-5 F	956050	111	FPAP 400/AC	955770	18	KKB 110.100	953288	42
BKDR 300-8 F	956081	111	FPAP 500/AC	955787	18	KKB 110.200	953295	42
BKDR 400	948543	110	FPAP 600/AC	955794	18	KKB 110.300	953301	42
BKDR 400-5 F	956067	111	FPAR 1000/AC	955985	25	KKB 110.400	953318	42
BKDR 400-8 F	956098	111	FPAR 2000/AC	955992	25	KKB 110.500	953325	42
BKM 6X30 E4	968336	98	FPAR 500/AC	955961	25	KKB 110.600	953332	42
BKS 155.200	962303	111	FPAR 750/AC	955978	25	KKB 50.100	953165	32
BKS 191.300	962310	111	FPBGV 10 E4	962662	24	KKB 50.150	953172	32
BKS 191.400	962327	111	FPCO 100/AC	963102	19	KKB 50.200	953189	32
BKT 140	057672	109	FPCO 150/AC	963119	19	KKB 50.300	953196	32
BKT 140/M	057689	109	FPCO 200/AC	963126	19	KKB 80.100	953202	37
BKT 176	057696	109	FPCO 300/AC	963133	19	KKB 80.150	953219	37
BKT 176/M	057719	109	FPDS 200/AC	955886	24	KKB 80.200	953226	37
DF 100 E4	957897	50	FPDS 300/AC	955893	24	KKB 80.250	953233	37
DF 100 E4	957897	96	FPDS 400/AC	955909	24	KKB 80.300	953240	37
DF 1060 E4	957910	51	FPDS 500/AC	955916	24	KKB 80.400	953257	37
DF 150 E4	957903	96	FPES 200/AC	955923	24	KKB 80.500	953264	37
DF 50 E4	957873	50	FPES 300/AC	955930	24	KKB 80.600	953271	37
DF 50 E4	957873	69	FPES 400/AC	955947	24	KKBA 110.100	953967	43
DF 50 E4	957873	96	FPES 500/AC	955954	24	KKBA 110.200	953974	43
DF 80 E4	957880	50	FPPS	963140	19	KKBA 110.300	953981	43
DF 80 E4	957880	69	HDS 50.50 C1KG	967056	22	KKBA 110.400	953998	43
DF 80 E4	957880	96	HDS 50.50 E5	962266	21	KKBA 110.500	954001	43
DF 94-4 E4	948550	110	HDS 50.50 F	931705	21	KKBA 110.600	954018	43
DF 94-C E4	957866	110	HU 5050/1000	858880	20	KKBA 50.050	953837	34
DF M	957927	50	HU 5050/1000 C1KG	967063	21	KKBA 50.100	953844	34
DF M	957927	69	HU 5050/1000 E5	965960	20	KKBA 50.150	953851	34
DF M	957927	99	HU 5050/1100	858903	20	KKBA 50.200	953868	34
DF M	957927	110	HU 5050/1100 C1KG	967070	21	KKBA 50.300	953875	34
DFUB 5.5X19 E4	062065	50	HU 5050/1200	858927	20	KKBA 80.100	953882	39
DFUB 5.5X19 E4	062065	69	HU 5050/1200 C1KG	967087	21	KKBA 80.150	953899	39
DFUB 5.5X19 E4	062065	97	HU 5050/1500	858941	20	KKBA 80.200	953905	39
DFUB 5.5X19 E4	062065	111	HU 5050/1500 C1KG	967094	21	KKBA 80.250	953912	39
DFW 100.150	968145	97	HU 5050/200	858705	20	KKBA 80.300	953929	39
DFW 100.200	968152	97	HU 5050/200 C1KG	967100	21	KKBA 80.400	953936	39
DFW 100.300	968169	97	HU 5050/200 E5	945757	20	KKBA 80.500	953943	39
DFW 100.400	968176	97	HU 5050/2000	858965	20	KKBA 80.600	953950	39
DFW 100.450	968183	97	HU 5050/2000 C1KG	967117	21	KKBAD 110.100	956753	48
DFW 100.500	968190	97	HU 5050/250	858729	20	KKBAD 110.200	956760	48
DFW 100.600	968206	97	HU 5050/250 C1KG	967124	21	KKBAD 110.300	956777	48
DFW 100.750	968213	97	HU 5050/300	858743	20	KKBAD 110.400	956784	48
DFW 100.900	968220	97	HU 5050/300 C1KG	967131	21	KKBAD 110.500	956791	48
DFW 150.150	968237	97	HU 5050/300 E5	945702	20	KKBAD 110.600	956807	48
DFW 150.200	968244	97	HU 5050/400	858767	20	KKBAD 50.050	956623	48
DFW 150.300	968251	97	HU 5050/400 C1KG	967148	21	KKBAD 50.050	956623	67
DFW 150.400	968268	97	HU 5050/400 E5	945764	20	KKBAD 50.100	956630	48
DFW 150.450	968275	97	HU 5050/500	858781	20	KKBAD 50.100	956630	67
DFW 150.500	968282	97	HU 5050/500 C1KG	967155	21	KKBAD 50.150	956647	48
DFW 150.600	968299	97	HU 5050/500 E5	945771	20	KKBAD 50.150	956647	67
DFW 150.750	968305	97	HU 5050/600	858804	20	KKBAD 50.200	956654	48
DFW 150.900	968312	97	HU 5050/600 C1KG	967162	21	KKBAD 50.200	956654	67
DFW 53.150	968022	97	HU 5050/600 E5	945788	20	KKBAD 50.300	956661	48
DFW 53.200	968039	97	HU 5050/700	858828	20	KKBAD 50.300	956661	67
DFW 53.300	968046	97	HU 5050/700 C1KG	967179	21	KKBAD 80.100	956678	48
DFW 53.400	968053	97	HU 5050/800	858842	20	KKBAD 80.100	956678	67
DFW 53.500	968060	97	HU 5050/800 C1KG	967186	21	KKBAD 80.150	956685	48
DFW 53.600	968077	97	HU 5050/800 E5	965953	20	KKBAD 80.150	956685	67
DFW 80.150	968084	97	HU 5050/900	858866	20	KKBAD 80.200	956692	48
DFW 80.200	968091	97	HU 5050/900 C1KG	967193	21	KKBAD 80.200	956692	67
DFW 80.300	968107	97	K 5050	347025	21	KKBAD 80.250	956708	48
DFW 80.400	968114	97	KA 100-600	347056	18	KKBAD 80.250	956708	67
DFW 80.500	968121	97	KK 110.100	952144	40	KKBAD 80.300	956715	48
DFW 80.600	968138	97	KK 110.200	952151	40	KKBAD 80.300	956715	67
FKM 6X16 E4	962693	52	KK 110.300	952168	40	KKBAD 80.400	956722	48
FKM 6X16 E4	962693	70	KK 110.400	952175	40	KKBAD 80.400	956722	67
FKM 6X16 E4	962693	98	KK 110.500	952182	40	KKBAD 80.500	956739	48
FKM 6X20 E4	962709	52	KK 110.600	952199	40	KKBAD 80.500	956739	67
FKM 6X20 E4	962709	70	KK 20.050	952007	30	KKBAD 80.600	956746	48
FKM 6X20 E4	962709	98	KK 50.050	952014	30	KKBAD 80.600	956746	67
FKM 8X20 K01	962716	52	KK 50.100	952021	30	KKBD 100	956371	46
FKM 8X20 K01	962716	70	KK 50.150	952038	30	KKBD 100	956371	66
FKM 8X20 K01	962716	98	KK 50.200	952045	30	KKBD 150	956388	46
FPAM 100	955848	18	KK 50.300	952052	30	KKBD 150	956388	66
FPAM 150	955855	18	KK 80.100	952069	35	KKBD 200	956395	46

model no.	EAN code	Page	model no.	EAN code	Page	model no.	EAN code	Page
KKBD 200	956395	66	KKCD 100	956456	66	KKETD 80.600	957118	49
KKBD 250	956401	46	KKCD 150	956463	46	KKETD 80.600	957118	68
KKBD 250	956401	66	KKCD 150	956463	66	KKGH 110	955640	40
KKBD 300	956418	46	KKCD 200	956470	46	KKGH 50	955626	31
KKBD 300	956418	66	KKCD 200	956470	66	KKGH 80	955633	35
KKBD 400	956425	46	KKCD 250	956487	46	KKGV 110	955152	42
KKBD 400	956425	66	KKCD 250	956487	66	KKGV 50	955138	33
KKBD 500	956432	46	KKCD 300	956494	46	KKGV 80	955145	38
KKBD 500	956432	66	KKCD 300	956494	66	KKIH 110 E4	955671	41
KKBD 600	956449	46	KKCD 400	956500	46	KKIH 50 E4	955657	31
KKBD 600	956449	66	KKCD 400	956500	66	KKIH 80 E4	955664	36
KKBI 110.100	954155	43	KKCD 500	956517	46	KKIV 110 E4	955183	42
KKBI 110.200	954162	43	KKCD 500	956517	66	KKIV 50 E4	955169	33
KKBI 110.300	954179	43	KKCD 600	956524	46	KKIV 80 E4	955176	38
KKBI 110.400	954186	43	KKCD 600	956524	66	KKKE 110.100	955329	40
KKBI 110.500	954193	43	KKD 100	956111	46	KKKE 110.200	955336	40
KKBI 110.600	954209	43	KKD 100	956111	94	KKKE 110.300	955343	40
KKBI 50.050	954025	33	KKD 150	956128	46	KKKE 110.400	955350	40
KKBI 50.100	954032	33	KKD 150	956128	94	KKKE 110.500	955367	40
KKBI 50.150	954049	33	KKD 200	956135	46	KKKE 110.600	955374	40
KKBI 50.200	954056	33	KKD 200	956135	94	KKKE 50.050	955190	30
KKBI 50.300	954063	33	KKD 250	956142	46	KKKE 50.100	955206	30
KKBI 80.100	954070	39	KKD 250	956142	94	KKKE 50.150	955213	30
KKBI 80.150	954087	39	KKD 300	956159	46	KKKE 50.200	955220	30
KKBI 80.200	954094	39	KKD 300	956159	94	KKKE 50.300	955237	30
KKBI 80.250	954100	39	KKD 400	956166	46	KKKE 80.100	955244	35
KKBI 80.300	954117	39	KKD 400	956166	94	KKKE 80.150	955251	35
KKBI 80.400	954124	39	KKD 450	956173	94	KKKE 80.200	955268	35
KKBI 80.500	954131	39	KKD 50	956104	94	KKKE 80.250	955275	35
KKBI 80.600	954148	39	KKD 500	956180	46	KKKE 80.300	955282	35
KKBID 110.100	956944	47	KKD 500	956180	94	KKKE 80.400	955299	35
KKBID 110.200	956951	47	KKD 600	956197	46	KKKE 80.500	955305	35
KKBID 110.300	956968	47	KKD 600	956197	94	KKKE 80.600	955312	35
KKBID 110.400	956975	47	KKD 750	956210	94	KKL 110.100	952342	40
KKBID 110.500	956982	47	KKD 900	956234	94	KKL 110.200	952359	40
KKBID 110.600	956999	47	KKET 110.100	954452	43	KKL 110.300	952366	40
KKBID 50.050	956814	47	KKET 110.200	954469	43	KKL 110.400	952373	40
KKBID 50.050	956814	66	KKET 110.300	954476	43	KKL 110.500	952380	40
KKBID 50.100	956821	47	KKET 110.400	954483	43	KKL 110.600	952397	40
KKBID 50.100	956821	66	KKET 110.500	954490	43	KKL 20.050	952205	30
KKBID 50.150	956838	47	KKET 110.600	954506	43	KKL 50.050	952212	30
KKBID 50.150	956838	66	KKET 50.100	954339	33	KKL 50.100	952229	30
KKBID 50.200	956845	47	KKET 50.150	954346	33	KKL 50.150	952236	30
KKBID 50.200	956845	66	KKET 50.200	954353	33	KKL 50.200	952243	30
KKBID 50.300	956852	47	KKET 50.300	954360	33	KKL 50.300	952250	30
KKBID 50.300	956852	66	KKET 80.100	954377	38	KKL 80.100	952267	35
KKBID 80.100	956869	47	KKET 80.150	954384	38	KKL 80.150	952274	35
KKBID 80.100	956869	67	KKET 80.200	954391	38	KKL 80.200	952281	35
KKBID 80.150	956876	47	KKET 80.250	954407	38	KKL 80.250	952298	35
KKBID 80.150	956876	67	KKET 80.300	954414	38	KKL 80.300	952304	35
KKBID 80.200	956883	47	KKET 80.400	954421	38	KKL 80.400	952311	35
KKBID 80.200	956883	67	KKET 80.500	954438	38	KKL 80.500	952328	35
KKBID 80.250	956890	47	KKET 80.600	954445	38	KKL 80.600	952335	35
KKBID 80.250	956890	67	KKETD 110.100	957125	49	KKRL 110.200	962532	42
KKBID 80.300	956906	47	KKETD 110.200	957132	49	KKRL 110.300	954988	42
KKBID 80.300	956906	67	KKETD 110.300	957149	49	KKRL 110.400	954995	42
KKBID 80.400	956913	47	KKETD 110.400	957156	49	KKRL 110.500	955008	42
KKBID 80.400	956913	67	KKETD 110.500	957163	49	KKRL 110.600	955015	42
KKBID 80.500	956920	47	KKETD 110.600	957170	49	KKRL 50.200	954919	32
KKBID 80.500	956920	67	KKETD 50.100	957002	48	KKRL 50.300	954926	32
KKBID 80.600	956937	47	KKETD 50.100	957002	67	KKRL 80.200	954933	38
KKBID 80.600	956937	67	KKETD 50.150	957019	48	KKRL 80.300	954940	38
KKC 110.100	953523	41	KKETD 50.150	957019	67	KKRL 80.400	954957	38
KKC 110.200	953530	41	KKETD 50.200	957026	48	KKRL 80.500	954964	38
KKC 110.300	953547	41	KKETD 50.200	957026	67	KKRL 80.600	954971	38
KKC 110.400	953554	41	KKETD 50.300	957033	48	KKRLD 200	957323	50
KKC 110.500	953561	41	KKETD 50.300	957033	67	KKRLD 200	957323	69
KKC 110.600	953578	41	KKETD 80.100	957040	49	KKRLD 300	957330	50
KKC 50.100	953400	32	KKETD 80.100	957040	68	KKRLD 300	957330	69
KKC 50.150	953417	32	KKETD 80.150	957057	49	KKRLD 400	957347	50
KKC 50.200	953424	32	KKETD 80.150	957057	68	KKRLD 400	957347	69
KKC 50.300	953431	32	KKETD 80.200	957064	49	KKRLD 500	957354	50
KKC 80.100	953448	37	KKETD 80.200	957064	68	KKRLD 500	957354	69
KKC 80.150	953455	37	KKETD 80.250	957071	49	KKRLD 600	957361	50
KKC 80.200	953462	37	KKETD 80.250	957071	68	KKRLD 600	957361	69
KKC 80.250	953479	37	KKETD 80.300	957088	49	KKRR 110.200	962549	42
KKC 80.300	953486	37	KKETD 80.300	957088	68	KKRR 110.300	955091	42
KKC 80.400	953493	37	KKETD 80.400	957095	49	KKRR 110.400	955107	42
KKC 80.500	953509	37	KKETD 80.400	957095	68	KKRR 110.500	955114	42
KKC 80.600	953516	37	KKETD 80.500	957101	49	KKRR 110.600	955121	42
KKCD 100	956456	46	KKETD 80.500	957101	68	KKRR 50.200	955022	32

LIST OF ITEMS

model no.	EAN code	Page	model no.	EAN code	Page	model no.	EAN code	Page
KKRR 50.300	955039	32	KKW 110.400	953806	41	KPGH 40	955695	59
KKRR 80.200	955046	37	KKW 110.500	953813	41	KPGH 40	955695	103
KKRR 80.300	955053	37	KKW 110.600	953820	41	KPGH 50	955701	59
KKRR 80.400	955060	37	KKW 50.050	953646	32	KPGH 50	955701	103
KKRR 80.500	955077	37	KKW 50.100	953653	32	KPGH 80	955718	63
KKRR 80.600	955084	37	KKW 50.150	953660	32	KPGH 80	955718	103
KKRRD 200	957378	50	KKW 50.200	953677	32	KPIH 40 E5	955688	59
KKRRD 200	957378	68	KKW 50.300	953684	32	KPKE 40.060	955381	59
KKRRD 300	957385	50	KKW 80.100	953691	37	KPKE 40.060	955381	104
KKRRD 300	957385	68	KKW 80.150	953707	37	KPKE 50.100	955398	59
KKRRD 400	957392	50	KKW 80.200	953714	37	KPKE 50.100	955398	104
KKRRD 400	957392	68	KKW 80.250	953721	37	KPKE 50.150	955404	59
KKRRD 500	957408	50	KKW 80.300	953738	37	KPKE 50.150	955404	104
KKRRD 500	957408	68	KKW 80.400	953745	37	KPKE 50.200	955411	59
KKRRD 600	957415	50	KKW 80.500	953752	37	KPKE 50.200	955411	104
KKRRD 600	957415	68	KKW 80.600	953769	37	KPKE 80.100	955428	63
KKSS 50.050	954780	31	KKWD 100	956548	47	KPKE 80.100	955428	104
KKSS 50.100	954797	31	KKWD 150	956555	47	KPKE 80.150	955435	63
KKSS 50.150	954803	31	KKWD 200	956562	47	KPKE 80.150	955435	104
KKSS 50.200	954810	31	KKWD 250	956579	47	KPKE 80.200	955442	63
KKSS 50.300	954827	31	KKWD 300	956586	47	KPKE 80.200	955442	104
KKSS 80.100	954834	36	KKWD 400	956593	47	KPKE 80.300	955459	63
KKSS 80.150	954841	36	KKWD 50	956531	47	KPKE 80.300	955459	104
KKSS 80.200	954858	36	KKWD 500	956609	47	KPL 40.060	952557	58
KKSS 80.250	954865	36	KKWD 600	956616	47	KPL 40.060/6	952632	58
KKSS 80.300	954872	36	KP 40.060	967612	58	KPL 50.100	952564	58
KKSSD 100	957279	49	KP 40.060/6	952472	58	KPL 50.100/6	952649	58
KKSSD 100	957279	68	KP 50.100	952403	58	KPL 50.150	952571	58
KKSSD 150	957286	49	KP 50.100/6	952489	58	KPL 50.150/6	952656	58
KKSSD 150	957286	68	KP 50.150	952410	58	KPL 50.200	952588	58
KKSSD 200	957293	49	KP 50.150/6	952496	58	KPL 50.200/6	952663	58
KKSSD 200	957293	68	KP 50.200	952427	58	KPL 80.100	952595	62
KKSSD 250	957309	49	KP 50.200/6	952502	58	KPL 80.100/6	952670	62
KKSSD 250	957309	68	KP 80.100	952434	62	KPL 80.150	952601	62
KKSSD 300	957316	49	KP 80.100/6	952519	62	KPL 80.150/6	952687	62
KKSSD 300	957316	68	KP 80.150	952441	62	KPL 80.200	952618	62
KKSSD 50	957262	49	KP 80.150/6	952526	62	KPL 80.200/6	952694	62
KKSSD 50	957262	68	KP 80.200	952458	62	KPL 80.300	952625	62
KKST 110.100	954698	41	KP 80.200/6	952533	62	KPL 80.300/6	952700	62
KKST 110.200	954704	41	KP 80.300	952465	62	KPSS 50.100/P	954889	59
KKST 110.300	954711	41	KP 80.300/6	952540	62	KPSS 50.150/P	954896	59
KKST 110.400	954728	41	KPB 50.100/P	953349	60	KPSS 50.200/P	954902	59
KKST 110.500	954735	41	KPB 50.150/P	953356	60	KPST 80.100/P	954759	63
KKST 110.600	954742	41	KPB 50.200/P	953363	60	KPST 80.150/P	967629	63
KKST 50.100	954575	31	KPB 80.100/P	953370	64	KPST 80.200/P	954766	63
KKST 50.150	954582	31	KPB 80.150/P	967643	64	KPST 80.300/P	954773	63
KKST 50.200	954599	31	KPB 80.200/P	953387	64	KPT 50	953127	59
KKST 50.300	954605	31	KPB 80.300/P	953394	64	KPT 50/M	953141	59
KKST 80.100	954612	36	KPBA 50.100/P	954216	61	KPT 80	953134	63
KKST 80.150	954629	36	KPBA 50.150/P	954223	61	KPT 80/M	953158	63
KKST 80.200	954636	36	KPBA 50.200/P	954230	61	KR 100	955466	70
KKST 80.250	954643	36	KPBA 80.100/P	954247	64	KR 100/M	955541	70
KKST 80.300	954650	36	KPBA 80.150/P	967674	64	KR 150	955473	70
KKST 80.400	954667	36	KPBA 80.200/P	954254	64	KR 150/M	955558	70
KKST 80.500	954674	36	KPBA 80.300/P	954261	64	KR 200	955480	70
KKST 80.600	954681	36	KPBI 50.100/P	954278	60	KR 200/M	955565	70
KKSTD 100	957187	49	KPBI 50.150/P	954285	60	KR 250	955497	70
KKSTD 100	957187	68	KPBI 50.200/P	954292	60	KR 250/M	955572	70
KKSTD 150	957194	49	KPBI 80.100/P	954308	64	KR 300	955503	70
KKSTD 150	957194	68	KPBI 80.150/P	967667	64	KR 300/M	955589	70
KKSTD 200	957200	49	KPBI 80.200/P	954315	64	KR 400	955510	70
KKSTD 200	957200	68	KPBI 80.300/P	954322	64	KR 400/M	955596	70
KKSTD 250	957217	49	KPC 50.100/P	953585	60	KR 500	955527	70
KKSTD 250	957217	68	KPC 50.150/P	953592	60	KR 500/M	955602	70
KKSTD 300	957224	49	KPC 50.200/P	953608	60	KR 600	955534	70
KKSTD 300	957224	68	KPC 80.100/P	953615	63	KR 600/M	955619	70
KKSTD 400	957231	49	KPC 80.150/P	967636	63	KTA 100	186907	17
KKSTD 400	957231	68	KPC 80.200/P	953622	63	KTA 100 C1KG	967209	17
KKSTD 500	957248	49	KPC 80.300/P	953639	63	KTA 100 E5	842605	17
KKSTD 500	957248	68	KPD 100	956258	66	KTA 150	187003	17
KKSTD 600	957255	49	KPD 150	956265	66	KTA 150 C1KG	967216	17
KKSTD 600	957255	68	KPD 200	956272	66	KTA 200	187102	17
KKT 110	953042	41	KPD 300	956289	66	KTA 200 C1KG	967223	17
KKT 110/M	953073	41	KPD 60	956241	66	KTA 200 E5	842629	17
KKT 50	953028	31	KPET 50.100/P	954513	60	KTA 250	187201	17
KKT 50/M	953059	31	KPET 50.150/P	954520	60	KTA 250 C1KG	967230	17
KKT 80	953035	36	KPET 50.200/P	954537	60	KTA 300	187300	17
KKT 80/M	953066	36	KPET 80.100/P	954544	64	KTA 300 C1KG	967247	17
KKW 110.100	953776	41	KPET 80.150/P	967650	64	KTA 300 E5	842643	17
KKW 110.200	953783	41	KPET 80.200/P	954551	64	KTA 350	187409	17
KKW 110.300	953790	41	KPET 80.300/P	954568	64	KTA 350 C1KG	967254	17

model no.	EAN code	Page	model no.	EAN code	Page	model no.	EAN code	Page
KTA 400	187508	17	SKM 10X30 E4	962730	70	UL 53.400	958009	76
KTA 400 C1KG	967261	17	SKM 10X30 E4	962730	98	UL 53.400/3	958016	76
KTA 400 E5	842667	17	SKM 10X40 E4	962747	52	UL 53.500	958023	76
KTA 450	187607	17	SKM 10X40 E4	962747	70	UL 53.500/3	958030	76
KTA 450 C1KG	967278	17	SKM 10X40 E4	962747	98	UL 53.600	958047	76
KTA 500	187706	17	TB	957934	52	UL 53.600/3	958054	76
KTA 500 C1KG	967285	17	TB	957934	70	UL 80.150	958061	80
KTA 500 E5	917402	17	U 5050/1000 C1KG	967339	23	UL 80.150/3	958078	80
KTA 550	187805	17	U 5050/1000 E5L	966028	22	UL 80.200	958085	80
KTA 550 C1KG	967292	17	U 5050/1000 F	918706	22	UL 80.200/3	958092	80
KTA 600	187904	17	U 5050/1100 C1KG	967346	23	UL 80.300	958108	80
KTA 600 C1KG	967308	17	U 5050/1100 F	918720	22	UL 80.300/3	958115	80
KTA 600 E5	917426	17	U 5050/1200 C1KG	967353	23	UL 80.400	958122	80
KTAM 100 E5	728305	17	U 5050/1200 F	918744	22	UL 80.400/3	958139	80
KTAM 200 E5	728404	17	U 5050/1500 C1KG	967360	23	UL 80.500	958146	80
KTAM 300 E5	728503	17	U 5050/1500 F	918768	22	UL 80.500/3	958153	80
KTAM 400 E5	728602	17	U 5050/2000 C1KG	967377	23	UL 80.600	958160	80
KU 5050	191956	23	U 5050/2000 F	918782	22	UL 80.600/3	958177	80
KU 5050 C1KG	967315	23	U 5050/300 C1KG	967384	23	ULB 100.150	958672	86
KU 5050 E5	967322	23	U 5050/300 E5L	965977	22	ULB 100.200	958689	86
LFG 40.060	948567	103	U 5050/300 F	918560	22	ULB 100.300	958696	86
LFG 50.100	948574	103	U 5050/3000 F	859306	22	ULB 100.400	958702	86
LFG 50.150	948581	103	U 5050/400 C1KG	967391	23	ULB 100.450	958719	86
LFG 50.200	948598	103	U 5050/400 E5L	965984	22	ULB 100.500	958726	86
LFG 80.100	948604	103	U 5050/400 F	918584	22	ULB 100.600	958733	86
LFG 80.150	948611	103	U 5050/500 C1KG	967407	23	ULB 100.750	958757	86
LFG 80.200	948628	103	U 5050/500 E5L	965991	22	ULB 100.900	958771	86
LFG 80.300	948635	103	U 5050/500 F	918607	22	ULB 150.150	958788	91
LFGAC 40.060	967605	104	U 5050/600 C1KG	967414	23	ULB 150.200	958795	91
LFGAC 50.100	948833	104	U 5050/600 E5L	966004	22	ULB 150.300	958801	91
LFGAC 50.150	948840	104	U 5050/600 F	918621	22	ULB 150.400	958818	91
LFGAC 50.200	948857	104	U 5050/6000 E5L	966035	22	ULB 150.450	958825	91
LFGAC 80.100	948864	104	U 5050/6000 F	859320	22	ULB 150.500	958832	91
LFGAC 80.150	948871	104	U 5050/700 C1KG	967421	23	ULB 150.600	958849	91
LFGAC 80.200	948888	104	U 5050/700 F	918645	22	ULB 150.750	958863	91
LFGAC 80.300	948895	104	U 5050/800 C1KG	967438	23	ULB 150.900	958887	91
LFGIC 40.060	948758	104	U 5050/800 E5L	966011	22	ULB 53.150	958559	78
LFGIC 50.100	948765	104	U 5050/800 F	918669	22	ULB 53.200	958566	78
LFGIC 50.150	948772	104	U 5050/900 C1KG	967445	23	ULB 53.300	958573	78
LFGIC 50.200	948789	104	U 5050/900 F	918683	22	ULB 53.400	958580	78
LFGIC 80.100	948796	104	UL 100.150	958184	84	ULB 53.500	958597	78
LFGIC 80.150	948802	104	UL 100.150/3	958191	84	ULB 53.600	958603	78
LFGIC 80.200	948819	104	UL 100.200	958207	84	ULB 80.150	958610	82
LFGIC 80.300	948826	104	UL 100.200/3	958214	84	ULB 80.200	958627	82
LFGKH 100	948710	103	UL 100.300	958221	84	ULB 80.300	958634	82
LFGKH 150	948727	103	UL 100.300/3	958238	84	ULB 80.400	958641	82
LFGKH 200	948734	103	UL 100.400	958245	84	ULB 80.500	958658	82
LFGKH 300	948741	103	UL 100.400/3	958252	84	ULB 80.600	958665	82
LFGKH 60	948703	103	UL 100.450	958269	84	ULBA 100.150	959013	87
LFGT 50	948659	104	UL 100.450/3	958276	84	ULBA 100.200	959020	87
LFGT 50/M	968343	104	UL 100.500	958283	84	ULBA 100.300	959037	87
LFGT 80	948666	104	UL 100.500/3	958290	84	ULBA 100.400	959044	87
LFGT 80/M	968350	104	UL 100.600	958306	84	ULBA 100.450	959051	87
LFGWC 40.060	948901	105	UL 100.600/3	958313	84	ULBA 100.500	959068	87
LFGWC 50.100	948918	105	UL 100.750	958344	84	ULBA 100.600	959075	87
LFGWC 50.150	948925	105	UL 100.750/3	958351	84	ULBA 100.750	959099	87
LFGWC 50.200	948932	105	UL 100.900	958382	84	ULBA 100.900	959112	87
LFGWC 80.100	948949	105	UL 100.900/3	958399	84	ULBA 150.150	959129	92
LFGWC 80.150	948956	105	UL 150.150	958405	89	ULBA 150.200	959136	92
LFGWC 80.200	948963	105	UL 150.150/3	965168	89	ULBA 150.300	959143	92
LFGWC 80.300	948970	105	UL 150.200	958412	89	ULBA 150.400	959150	92
MP 110	963034	44	UL 150.200/3	965175	89	ULBA 150.450	959167	92
MP 50	963010	34	UL 150.300	958429	89	ULBA 150.500	959174	92
MP 80	963027	39	UL 150.300/3	965182	89	ULBA 150.600	959181	92
PR M860/PA6	968398	123	UL 150.400	958436	89	ULBA 150.750	959204	92
PR-MC 10	965489	123	UL 150.400/3	965199	89	ULBA 150.900	959228	92
PR-MC 10 GH	968367	123	UL 150.450	958443	89	ULBA 53.150	958894	78
PR-MC 10 GM	968374	123	UL 150.450/3	965205	89	ULBA 53.200	958900	78
PR-MC 10 KE	968381	123	UL 150.500	958450	89	ULBA 53.300	958917	78
PR-MC 22	965496	124	UL 150.500/3	965212	89	ULBA 53.400	958924	78
PR-MC 22 BA	966158	125	UL 150.600	958467	89	ULBA 53.500	958931	78
PR-MC 22 HBV	966219	125	UL 150.600/3	965229	89	ULBA 53.600	958948	78
PR-MC 22 KE	966172	124	UL 150.750	958481	89	ULBA 80.150	958955	82
PR-MC 22 KE/C	966196	124	UL 150.750/3	965243	89	ULBA 80.200	958962	82
PR-MC 22 KE/CP	966202	125	UL 150.900	958504	89	ULBA 80.300	958979	82
PR-MC 22 KE/P	966189	124	UL 150.900/3	965267	89	ULBA 80.400	958986	82
PR-MC 30	965502	126	UL 53.150/3	957958	76	ULBA 80.500	958993	82
PR-MC 30 HBV	968404	126	UL 53.200	957965	76	ULBA 80.600	959006	82
PR-MC 30 IH	966226	126	UL 53.200/3	957972	76	ULBAD 100.150	957538	95
PR-MC 30 KE	966233	126	UL 53.300	957989	76	ULBAD 100.200	957545	95
SKM 10X30 E4	962730	52	UL 53.300/3	957996	76	ULBAD 100.300	957552	95

LIST OF ITEMS

model no.	EAN code	Page	model no.	EAN code	Page	model no.	EAN code	Page
ULBAD 100.400	957569	95	ULKE 150.300	965656	89	ULTE 53.150	959235	77
ULBAD 100.450	957576	95	ULKE 150.400	965663	89	ULTE 53.200	959242	77
ULBAD 100.500	957583	95	ULKE 150.450	965670	89	ULTE 53.300	959259	77
ULBAD 100.600	957590	95	ULKE 150.500	965687	89	ULTE 53.400	959266	77
ULBAD 100.750	957613	95	ULKE 150.600	965694	89	ULTE 53.500	959273	77
ULBAD 100.900	957637	95	ULKE 150.750	965717	89	ULTE 53.600	959280	77
ULBAD 150.150	059089	95	ULKE 150.900	965731	89	ULTE 80.150	959297	81
ULBAD 150.200	059096	95	ULKE 53.150	965748	76	ULTE 80.200	959303	81
ULBAD 150.300	059119	95	ULKE 53.200	965755	76	ULTE 80.300	959310	81
ULBAD 150.400	059126	95	ULKE 53.300	965762	76	ULTE 80.400	959327	81
ULBAD 150.450	059133	95	ULKE 53.400	965779	76	ULTE 80.500	959334	81
ULBAD 150.500	059140	95	ULKE 53.500	965786	76	ULTE 80.600	959341	81
ULBAD 150.600	059157	95	ULKE 53.600	965793	76	ULTED 150	957644	96
ULBAD 150.750	059164	95	ULKE 80.150	965809	80	ULTED 200	957651	96
ULBAD 150.900	059171	95	ULKE 80.200	965816	80	ULTED 300	957668	96
ULBAD 53.150	059188	94	ULKE 80.300	965823	80	ULTED 400	957675	96
ULBAD 53.200	059195	94	ULKE 80.400	965830	80	ULTED 450	957682	96
ULBAD 53.300	059218	94	ULKE 80.500	965847	80	ULTED 500	957699	96
ULBAD 53.400	059225	94	ULKE 80.600	965854	80	ULTED 600	957705	96
ULBAD 53.500	059232	94	ULKG	960316	98	ULTED 750	957729	96
ULBAD 53.600	059249	94	ULKH E4	960323	98	ULTED 900	957743	96
ULBAD 80.150	059256	95	ULKV E4	960330	96	ULTL 100	958535	85
ULBAD 80.200	059263	95	ULP 100	960347	99	ULTL 150	958542	90
ULBAD 80.300	059270	95	ULRU 100.100	960019	87	ULTL 53	958511	77
ULBAD 80.400	059287	95	ULRU 100.150	960026	87	ULTL 80	958528	81
ULBAD 80.500	059294	95	ULRU 100.200	960033	87	ULX 100.150	959693	86
ULBAD 80.600	059317	95	ULRU 100.300	960040	87	ULX 100.200	959709	86
ULBD 150	957422	94	ULRU 100.400	960057	87	ULX 100.300	959716	86
ULBD 200	957439	94	ULRU 100.500	960064	87	ULX 100.400	959723	86
ULBD 300	957446	94	ULRU 100.600	960071	87	ULX 100.450	959730	86
ULBD 400	957453	94	ULRU 150.100	960088	92	ULX 100.500	959747	86
ULBD 450	957460	94	ULRU 150.150	960095	92	ULX 100.600	959754	86
ULBD 500	957477	94	ULRU 150.200	960101	92	ULX 100.750	959778	86
ULBD 600	957484	94	ULRU 150.300	960118	92	ULX 100.900	959792	86
ULBD 750	957507	94	ULRU 150.400	960125	92	ULX 150.150	959808	91
ULBD 900	957521	94	ULRU 150.500	960132	92	ULX 150.200	959815	91
ULGH 100	960170	85	ULRU 150.600	960149	92	ULX 150.300	959822	91
ULGH 150	960187	90	ULRU 53.100	959914	78	ULX 150.400	959839	91
ULGH 53	960156	76	ULRU 53.150	959921	78	ULX 150.450	959846	91
ULGH 80	960163	80	ULRU 53.200	959938	78	ULX 150.500	959853	91
ULGV 100	960255	87	ULRU 53.300	959945	78	ULX 150.600	959860	91
ULGV 150	960262	92	ULRU 53.400	959952	78	ULX 150.750	959884	91
ULGV 53	960231	79	ULRU 80.100	959969	82	ULX 150.900	959907	91
ULGV 80	960248	83	ULRU 80.150	959976	82	ULX 53.150	959570	77
ULIH 100 E4	960217	85	ULRU 80.200	959983	82	ULX 53.200	959587	77
ULIH 150 E4	960224	90	ULRU 80.300	959990	82	ULX 53.300	959594	77
ULIH 53 E4	960194	77	ULRU 80.400	960002	82	ULX 53.400	959600	77
ULIH 80 E4	960200	81	ULRU 100.150	959358	85	ULX 53.500	959617	77
ULIV 100 E4	960293	88	ULTE 100.200	959365	85	ULX 53.600	959624	77
ULIV 150 E4	960309	93	ULTE 100.300	959372	85	ULX 80.150	959631	81
ULIV 53 E4	960279	79	ULTE 100.400	959389	85	ULX 80.200	959648	81
ULIV 80 E4	960286	83	ULTE 100.450	959396	85	ULX 80.300	959655	81
ULKE 100.150	965526	84	ULTE 100.500	959402	85	ULX 80.400	959662	81
ULKE 100.200	965533	84	ULTE 100.600	959419	85	ULX 80.500	959679	81
ULKE 100.300	965540	84	ULTE 100.750	959433	85	ULX 80.600	959686	81
ULKE 100.400	965557	84	ULTE 100.900	959457	85	ULXD 150	957750	96
ULKE 100.450	965564	84	ULTE 150.150	959464	90	ULXD 200	957767	96
ULKE 100.500	965571	84	ULTE 150.200	959471	90	ULXD 300	957774	96
ULKE 100.600	965588	84	ULTE 150.300	959488	90	ULXD 400	957781	96
ULKE 100.700	965595	84	ULTE 150.400	959495	90	ULXD 450	957798	96
ULKE 100.750	965601	84	ULTE 150.450	959501	90	ULXD 500	957804	96
ULKE 100.800	965618	84	ULTE 150.500	959518	90	ULXD 600	957811	96
ULKE 100.900	965625	84	ULTE 150.600	959525	90	ULXD 750	957835	96
ULKE 150.150	965632	89	ULTE 150.750	959549	90	ULXD 900	957859	96
ULKE 150.200	965649	89	ULTE 150.900	959563	90	WWU 150/8 E5	728909	99

NOTES

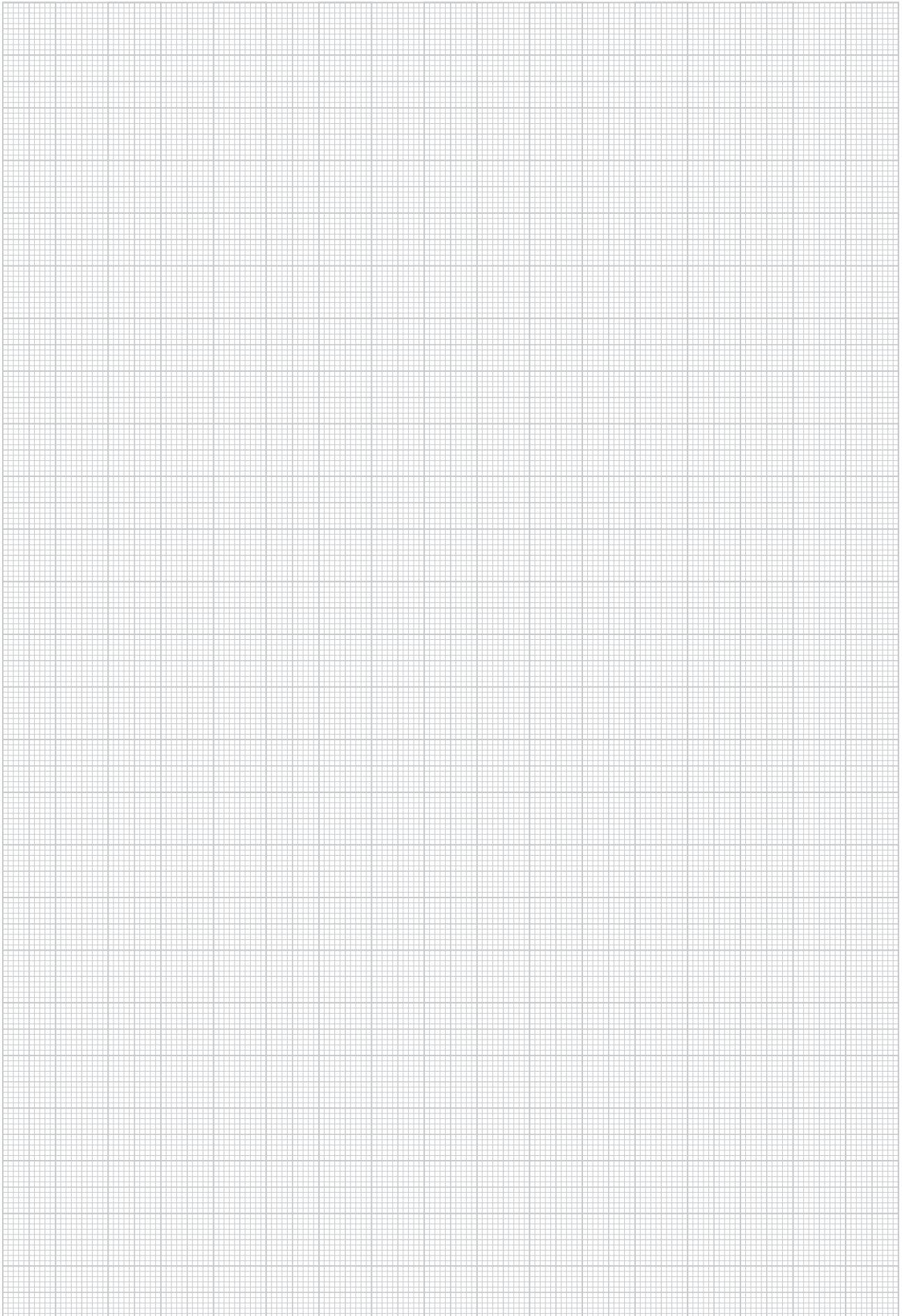

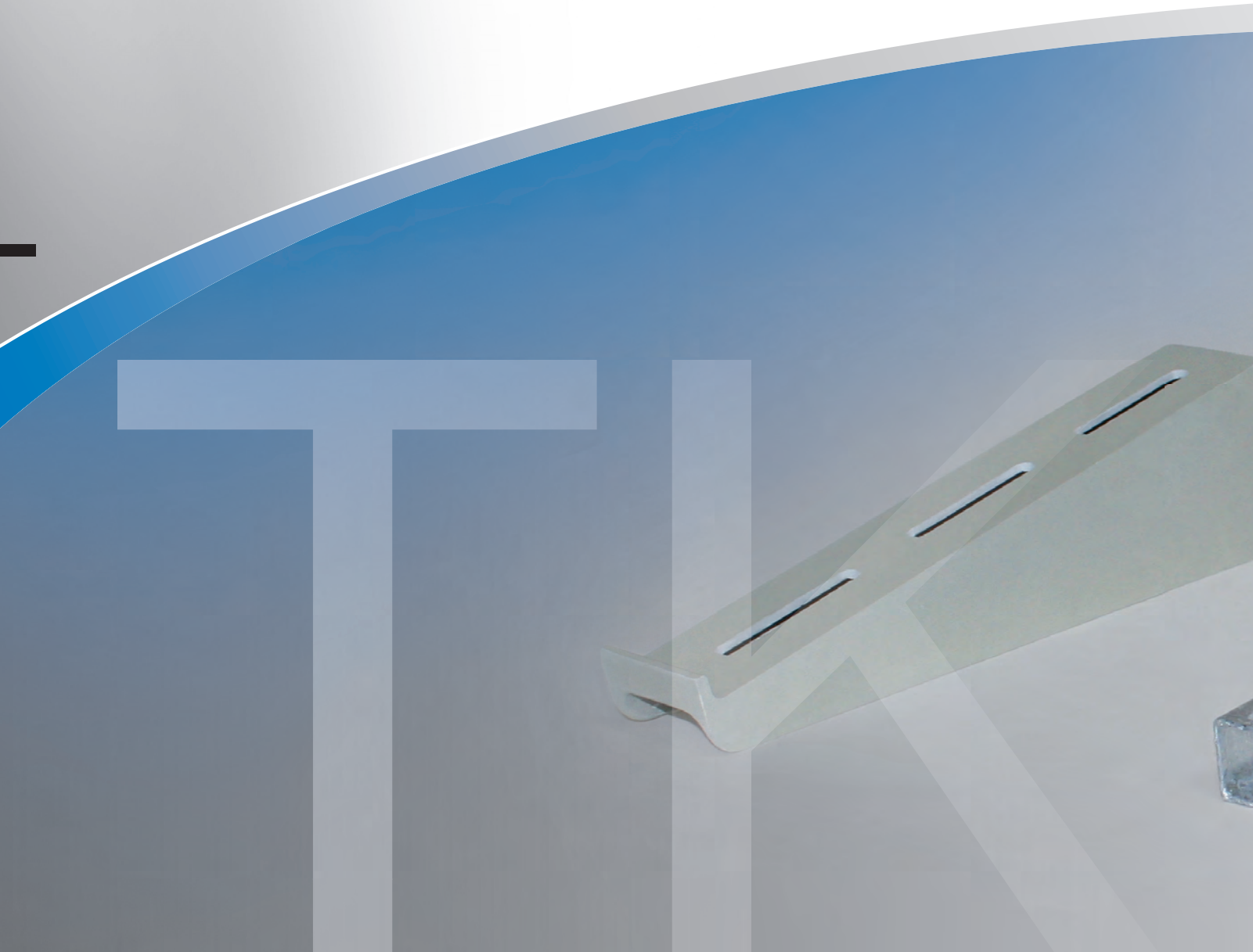

Support System

○ Ceiling bracket and wall bracket

○ Profiles

○ Brackets

○ Mounting plates

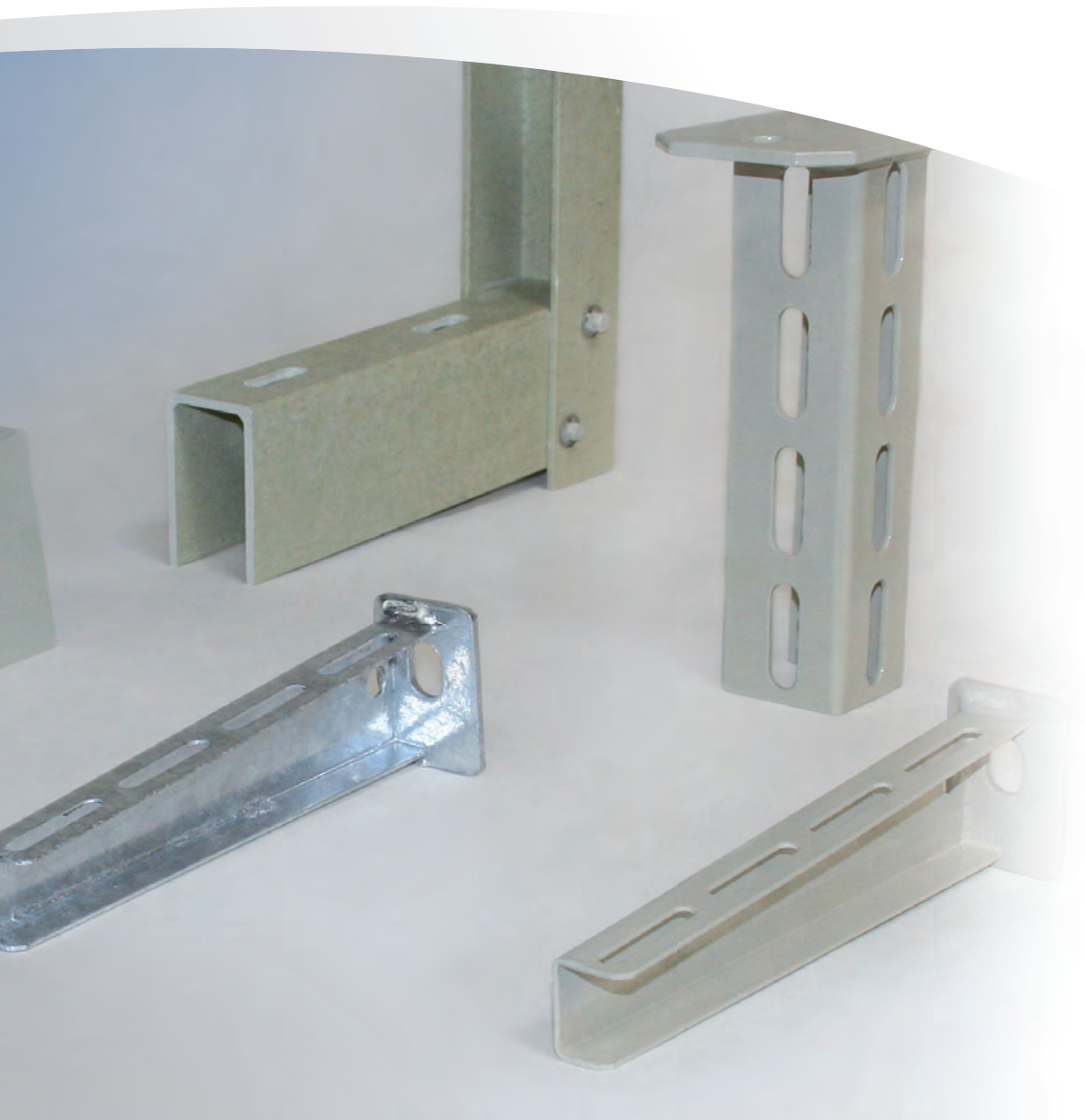

Compatible with our different ranges of cable trays, our supporting systems are available in several finishes and different support structures. A range of support structures ranging from hot-dip galvanized steel and epoxy, through the stainless steel, loaded polyester reinforced fiberglass.

Dimensions and perforations supports are suitable for EBO Systems cables trays.
The load capacities are variable according to the type of installation (ceiling, wall ...).

Overview brackets and hangers

SYSTEM	Hangers and wall supports - average load	KTAM	17	
	Hangers and wall supports, standard	KTA	17	
	GRP brackets, pultruded	FPAP	18	
	GRP brackets, pressed	FPAM	18	
	GRP brackets, pultruded, Z Profil	FPCO	19	
	GRP support, pultruded	FPPS	19	
	Hangers, U profile	HU 5050	20/21	
	Hangers-profiles	HDS	21/22	
	Profil	U 5050	22/23	
	Anchor fixing plate	KU 5050	23	
	GRP hangers, U profil	FPES	24	
	GRP hangers, pultruded, Profil C	FPDS	24	
	ACCESSORIES	STAINLESS STEEL Fixing system SS anchor bolt	FPBGV	24
		Track C-Profil, opening of 15 mm, perforated	FPAR	25
Protective cover		KA	18	
Protective cover		K 5050	21	

The classification of brackets and hangers into categories like light, medium and heavy is only an indication for their typical usage. For engineering purposes exact calculations of overall loads considering the weight of the cable, the weight of the tray and the support span are mandatory.
In the event that the support structures and loads of cables are uniformly distributed, the supporting capacity of the bracket must be calculated as follows:
load $F = (\text{cables weight} + \text{weight of the various components of the support installation}) \times \text{support distance}$

Load ratings shown in this catalog are valid only for proper anchorage to the building structure. Please refer to the general information section and consult site management or structural engineering for details about the building structure and local regulations.

Hanger and wall bracket

middle range

Item ref.	Height mm	Length L mm	adj. at L/2 kN	Accessories/ bolts included	EAN code	Weight 100 units pc.	Min. pack.
E5 KTAM 100 E5	60	110	1,2	2 FLM 6x12 E5	728305	16,51	20 p.
E5 KTAM 200 E5	80	210	1,2	2 FLM 6x12 E5	728404	30,61	20 p.
E5 KTAM 300 E5	85	310	1,2	2 FLM 6x12 E5	728503	44,33	20 p.
E5 KTAM 400 E5	115	410	1,2	2 FLM 6x12 E5	728602	73,59	20 p.

for a wall mounting or a ceiling mounting

Warning: different properties for various lengths

The load capacities are only valid if the main supporting part is sufficiently and correctly fixed, particularly the ceiling supports.

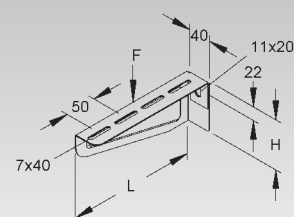

Ceiling support and wall bracket

standard range

Item ref.	Height mm	Width B mm	Length L mm	adj. at L/2 kN	Accessories/ bolts included	EAN code	Weight 100 units pc./	Min. pack.
F KTA 100	45	40	110	2,5	2 FLM 6x12	186907	13,60	20 p.
F KTA 150	45	40	160	2,5	2 FLM 6x12	187003	16,90	20 p.
F KTA 200	55	40	210	2,5	2 FLM 6x12	187102	25,20	20 p.
F KTA 250	55	40	260	2,5	2 FLM 6x12	187201	29,80	20 p.
F KTA 300	65	50	310	2,5	2 FLM 6x12	187300	55,80	20 p.
F KTA 350	65	50	360	2,5	2 FLM 6x12	187409	62,70	20 p.
F KTA 400	75	50	410	2,5	2 FLM 6x12	187508	75,20	20 p.
F KTA 450	75	50	460	2,5	2 FLM 6x12	187607	83,80	10 p.
F KTA 500	90	50	510	2,5	2 FLM 6x12	187706	106,70	10 p.
F KTA 550	90	50	560	2,5	2 FLM 6x12	187805	129,20	10 p.
F KTA 600	90	50	610	2,5	2 FLM 6x12	187904	122,80	10 p.
E5 KTA 100 E5	45	40	110	2,5	2 FLM 6x12 E5	842605	14,80	20 p.
E5 KTA 200 E5	55	40	210	2,5	2 FLM 6x12 E5	842629	25,92	20 p.
E5 KTA 300 E5	65	50	310	2,5	2 FLM 6x12 E5	842643	55,69	20 p.
E5 KTA 400 E5	90	50	410	2,5	2 FLM 6x12 E5	842667	80,00	20 p.
E5 KTA 500 E5	110	50	510	2,5	2 FLM 6x12 E5	917402	120,00	20 p.
E5 KTA 600 E5	110	50	610	2,5	2 FLM 6x12 E5	917426	135,00	20 p.

for a wall mounting and for a ceiling mounting

Oblong holes dimensions LL 7x40 mm in the KTA 100-600 series

Oblong holes dimensions LL 7x15 mm in the KTA 150-550 series (intermediate sizes) and in the aluminum finish KTA 100-600

The load capacities are only valid if the main supporting part is sufficiently and correctly fixed, particularly the ceiling supports.

Mounting accessories required for cable ladder UL : ULKG, M10x30 V4A (to be ordered separately)

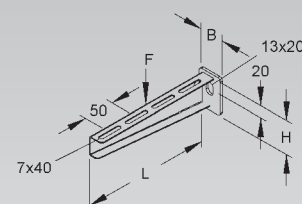

Ceiling support and wall bracket

epoxy, standard

Item ref.	RAL colour	Height mm	Width B mm	Length L mm	adj. at L/2 kN	Accessories/ bolts included	EAN code	Weight 100 units pc	Min. pack.
C1 KTA 100 C1KG	7032	45	40	110	2,5	2 FLM 6x12 E5	967209	13,1	1 p.
C1 KTA 150 C1KG	7032	45	40	160	2,5	2 FLM 6x12 E5	967216	16,4	1 p.
C1 KTA 200 C1KG	7032	55	40	210	2,5	2 FLM 6x12 E5	967223	24,4	1 p.
C1 KTA 250 C1KG	7032	55	40	260	2,5	2 FLM 6x12 E5	967230	28,8	1 p.
C1 KTA 300 C1KG	7032	65	50	310	2,5	2 FLM 6x12 E5	967247	53,9	1 p.
C1 KTA 350 C1KG	7032	65	50	360	2,5	2 FLM 6x12 E5	967254	60,7	1 p.
C1 KTA 400 C1KG	7032	75	50	410	2,5	2 FLM 6x12 E5	967261	72,8	1 p.
C1 KTA 450 C1KG	7032	75	50	460	2,5	2 FLM 6x12 E5	967278	81,1	1 p.
C1 KTA 500 C1KG	7032	90	50	510	2,5	2 FLM 6x12 E5	967285	103,3	1 p.
C1 KTA 550 C1KG	7032	90	50	560	2,5	2 FLM 6x12 E5	967292	125,0	1 p.
C1 KTA 600 C1KG	7032	90	50	610	2,5	2 FLM 6x12 E5	967308	118,8	1 p.

for a wall mounting on supporting rail FPAR and on ceiling support FPES / FPDS

Oblong holes dimensions LL 7x40 mm in the KTA 100-600 series

Oblong holes dimensions LL 7x15 mm in the KTA 150-550 series (intermediate sizes) and in the aluminum finish KTA 100-600

The load capacities are only valid if the main supporting part is sufficiently and correctly fixed, particularly the ceiling supports.

Mounting accessories required for cable ladder UL: ULKG, M6x30 V4A (to be ordered separately)

Mounting accessories required for cable ladder UL: ULKG, M10x30 V4A (to be ordered separately)

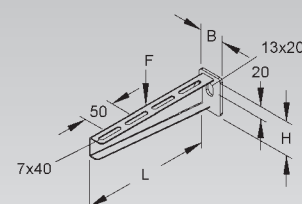

SUPPORT SYSTEM

Protective end cap

Item ref.	Colour	EAN code	Weight 100 units	Min. pack.	
K10	KA 100-600	yellow	347056	1,4	10 p.

to protect the profile ends

The end caps must be prescribed in areas where the risk of hazard is important!

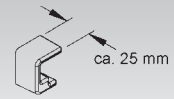

GRP bracket

pultruded

Item ref.	RAL colour	Length L mm	adj. at L/2 kN	EAN code	Weight 100 units pc./pc	Min. pack.	
K23	FPAP 100/AC	7032	110	1,25	955725	47,0	1 p.
K23	FPAP 150/AC	7032	160	1,25	955732	54,5	1 p.
K23	FPAP 200/AC	7032	210	1,25	955749	58,5	1 p.
K23	FPAP 250/AC	7032	260	1,25	955756	65,0	1 p.
K23	FPAP 300/AC	7032	310	1,25	955763	72,2	1 p.

for a wall mounting and for a ceiling mounting

Used for: Hanger FPES... and FPDS...

The load capacities are only valid if the main supporting part is sufficiently and correctly fixed, particularly the ceiling supports.

Fixing accessories for cables trays (to be ordered separately) :
for cables trays K² and KP : M6x20 V4A

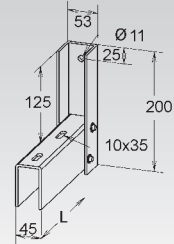

GRP bracket

pultruded

Item ref.	RAL colour	Length L mm	adj. at L/2 kN	EAN code	Weight 100 units pc	Min. pack.	
K23	FPAP 400/AC	7032	410	1,25	955770	161,5	1 p.
K23	FPAP 500/AC	7032	510	1,25	955787	174,5	1 p.
K23	FPAP 600/AC	7032	610	1,25	955794	186,0	1 p.

for a wall mounting and for a ceiling mounting

Used for: Hanger FPES... and FPDS...

The load capacities are only valid if the main supporting part is sufficiently and correctly fixed, particularly the ceiling supports.

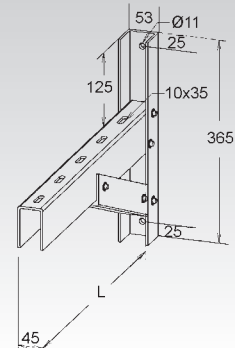

GRP bracket

pressed

Item ref.	RAL colour	Height mm	Width B mm	Length L mm	adj. at L/2 kN	EAN code	Weight 100 units pc.	Min. pack.	
K23	FPAM 100	7032	50	55	120	1,25	955848	17	1 p.
K23	FPAM 150	7032	60	55	170	1,25	955855	18	1 p.
K23	FPAM 200	7032	70	55	220	1,25	955862	36	1 p.
K23	FPAM 300	7032	90	55	320	1,25	955879	50	1 p.

for a wall mounting and for a ceiling mounting

Used for: Hanger FPES... and FPDS...

The load capacities are only valid if the main supporting part is sufficiently and correctly fixed, particularly the ceiling supports.

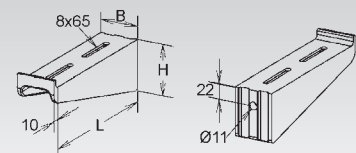

GRP bracket

pultruded, Z-profile

Item ref.	RAL colour	Width B mm	EAN code	Weight 100 units pc	Min. pack.
K23 FPCO 100/AC	7032	100	963102	55	1 p.
K23 FPCO 150/AC	7032	150	963119	68	1 p.
K23 FPCO 200/AC	7032	200	963126	77	1 p.
K23 FPCO 300/AC	7032	300	963133	100	1 p.

for the horizontal mounting of cable trays

Used for: Only for the cable trays KK... and KP...

Mounting accessories required for cable tray K2 and KP : M6x20 V4A (to be ordered separately)

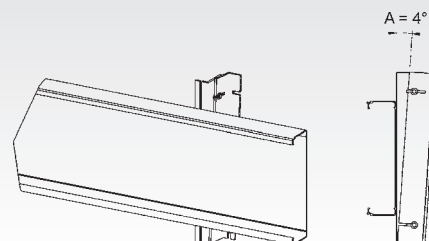
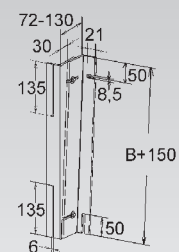

GRP support

pultruded, Z-profile

Item ref.	RAL colour	EAN code	Weight 100 units pc	Min. pack.
K23 FPPS	7032	963140	0	1 p.

for the horizontal mounting of cable trays

The support is universal

Used for: Only for the cable trays KK... and KP... and UL...

Mounting accessories required for cable tray K2 and KP : M6x20 V4A (to be ordered separately)

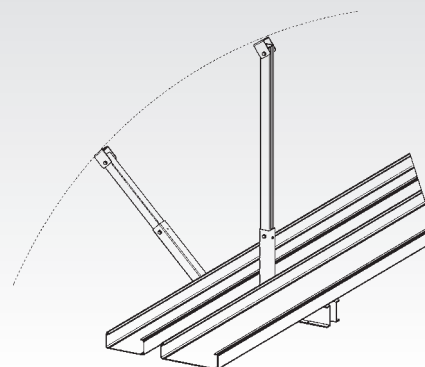
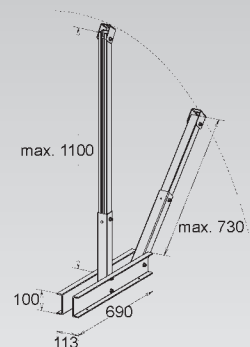

SUPPORT SYSTEM

Ceiling support

Profile U

	Item ref.	Total length L mm	EAN code	Weight 100 units pc./pc	Min. pack.
F	HU 5050/200	205	858705	93,08	1 p.
F	HU 5050/250	255	858729	105,23	1 p.
F	HU 5050/300	305	858743	117,38	1 p.
F	HU 5050/400	405	858767	141,68	1 p.
F	HU 5050/500	505	858781	165,97	1 p.
F	HU 5050/600	605	858804	190,27	1 p.
F	HU 5050/700	705	858828	214,57	1 p.
F	HU 5050/800	805	858842	238,87	1 p.
F	HU 5050/900	905	858866	263,17	1 p.
F	HU 5050/1000	1005	858880	287,46	1 p.
F	HU 5050/1100	1105	858903	311,76	1 p.
F	HU 5050/1200	1205	858927	336,06	1 p.
F	HU 5050/1500	1505	858941	408,95	1 p.
F	HU 5050/2000	2005	858965	530,44	1 p.
E5	HU 5050/200 E5	205	945757	86,02	1 p.
E5	HU 5050/300 E5	305	945702	108,48	1 p.
E5	HU 5050/400 E5	405	945764	130,92	1 p.
E5	HU 5050/500 E5	505	945771	153,38	1 p.
E5	HU 5050/600 E5	605	945788	175,83	1 p.
E5	HU 5050/800 E5	805	965953	220,74	1 p.
E5	HU 5050/1000 E5	1005	965960	265,65	1 p.

Total length = U profile length, included fixing plate.

HU 5050/200, has limited space for equipment in cable trays (bracket length & height)

Used for: Rail FPAP and wall mounted bracket FPAP

Rail and wall mounted bracket KTA...

In order to avoid the deformation of ceiling support during the mounting of brackets, it is necessary for mechanical reason, to take into account of the thickness of the ceiling support when screwing the hexagonal bolts.

for static reasons and to facilitate the mounting of end caps, the bracket must be mounted at $x=50$ mm above the ceiling support end.

To prevent the deformation of the ceiling support profile when installing the brackets, it is recommended to use hexagonal head bolts for mechanical reasons.

Serie of oblong holes (13x40 mm) on 3 profile sides.

The load data are only valid in case of a sufficiently strong fixing of the supporting part. The share of loads in the building must be defined with the contractor. You must follow the guidelines and definitions in force.

Load diagram : deflection of the hanger in case of one-sided charges

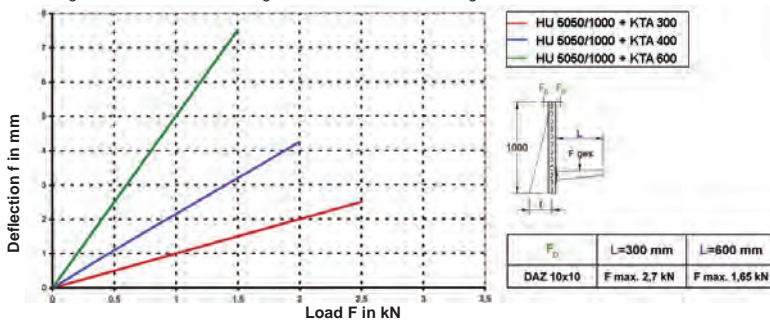

In case of symmetrical loads, the deflection is not significant.

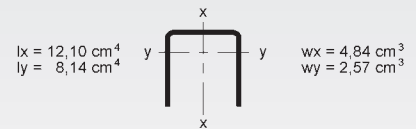
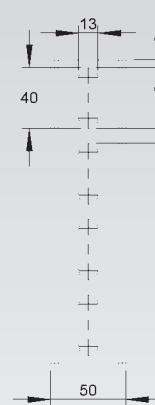
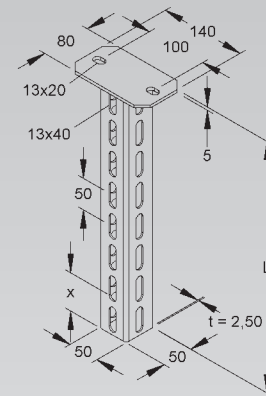

Hanger

epoxy, U-profile

Item ref.	RAL colour	Total length L	EAN code	Weight 100 units pc	Min. pack.	
		mm				
C1	HU 5050/200 C1KG	7032	205	967100	88,0	1 p.
C1	HU 5050/250 C1KG	7032	255	967124	99,5	1 p.
C1	HU 5050/300 C1KG	7032	305	967131	111,0	1 p.
C1	HU 5050/400 C1KG	7032	405	967148	133,9	1 p.
C1	HU 5050/500 C1KG	7032	505	967155	156,9	1 p.
C1	HU 5050/600 C1KG	7032	605	967162	179,9	1 p.
C1	HU 5050/700 C1KG	7032	705	967179	202,9	1 p.
C1	HU 5050/800 C1KG	7032	805	967186	225,8	1 p.
C1	HU 5050/900 C1KG	7032	905	967193	248,8	1 p.
C1	HU 5050/1000 C1KG	7032	1005	967063	271,8	1 p.
C1	HU 5050/1100 C1KG	7032	1105	967070	294,8	1 p.
C1	HU 5050/1200 C1KG	7032	1205	967087	317,7	1 p.
C1	HU 5050/1500 C1KG	7032	1505	967094	386,6	1 p.
C1	HU 5050/2000 C1KG	7032	2005	967117	501,5	1 p.

Total length = U profile length, included fixing plate.

HU 5050/200, has limited space for equipment in cable trays (bracket length & height)

Used for: Hangers FPES / FPDS and wall bracket FPAP
Rail FPAP and wall mounted bracket FPAP

Load diagram : deflection of the hanger in case of one-sided charges

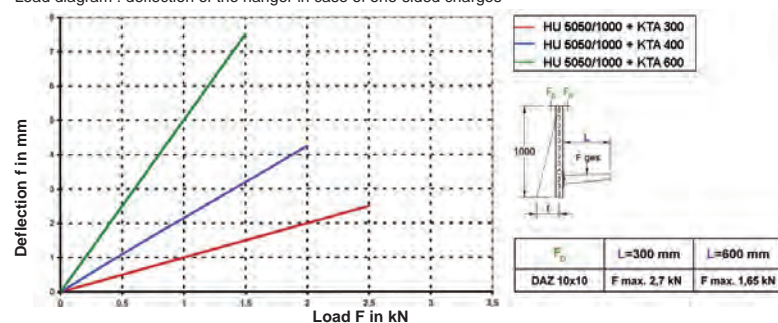

In case of symmetrical loads, the deflection is not significant.

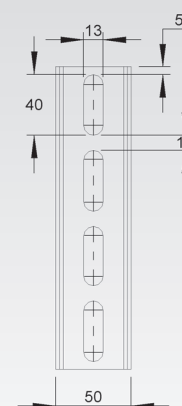
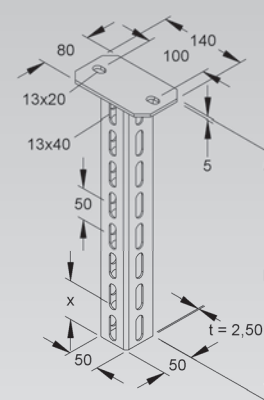

$$\begin{aligned}
 I_x &= 12,10 \text{ cm}^4 & I_y &= 8,14 \text{ cm}^4 \\
 W_x &= 4,84 \text{ cm}^3 & W_y &= 2,57 \text{ cm}^3
 \end{aligned}$$

Protective end cap

Item ref.	Colour	EAN code	Weight 100 units pc.	Min. pack.	
K10	K 5050	yellow	347025	3	10 p.

to protect the profile ends

The end caps must be prescribed in areas where the risk of hazard is important!

Used for: Profile U 5050/... and hanger HU 5050/...

To facilitate the assembly of end caps, a minimum space of 50 mm is required between the bracket bottom and the ceiling support end.

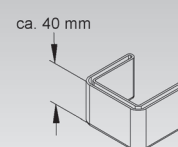

Ceiling support profile

Item ref.	Accessories/ bolts included	EAN code	Weight 100 units pc./pc	Min. pack.	
F	HDS 50.50 F	1 SKM 10x80 F, 2 UGM 10	931705	7,5	50 p.
E5	HDS 50.50 E5	1 SKM 10x90 E4, 2 UGM 10	962266	6,8	50 p.

Used for: Profile U 5050/... and hanger HU 5050/...

In order to avoid the deformation of ceiling support during the mounting of brackets, it is necessary for mechanical reasons, to take into account of the thickness of the ceiling support when screwing the hexagonal bolts.

To prevent the deformation of the ceiling support profile when installing the brackets, it is recommended to use hexagonal head bolts for mechanical reasons.

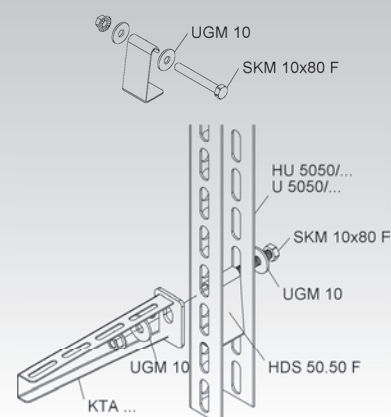

SUPPORT SYSTEM

Ceiling support profile

epoxy

Item ref.	RAL colour	Accessories/ bolts included	EAN code	Weight 100 units pc	Min. pack.	
C1	HDS 50.50 C1KG	7032	1 SKM 10x90 E4, 2 UGM 10	967056	7,5	10 p.

Used for: Profile U 5050/... C1KG and hanger HU 5050/... C1KG

To prevent the deformation of the ceiling support profile when installing the brackets, it is recommended to use hexagonal head bolts for mechanical reasons.



Profile U 5050

Item ref.	Length L mm	EAN code	Weight 100 units pc./pc/m	Min. pack.	
F	U 5050/300 F	300	918560	72,90	1 p.
F	U 5050/400 F	400	918584	97,20	1 p.
F	U 5050/500 F	500	918607	121,50	1 p.
F	U 5050/600 F	600	918621	145,79	1 p.
F	U 5050/700 F	700	918645	170,09	1 p.
F	U 5050/800 F	800	918669	194,38	1 p.
F	U 5050/900 F	900	918683	218,68	1 p.
F	U 5050/1000 F	1000	918706	242,98	1 p.
F	U 5050/1100 F	1100	918720	267,28	1 p.
F	U 5050/1200 F	1200	918744	291,58	1 p.
F	U 5050/1500 F	1500	918768	364,47	1 p.
F	U 5050/2000 F	2000	918782	242,98	2 m
F	U 5050/3000 F	3000	859306	242,98	3 m
F	U 5050/6000 F	6000	859320	242,98	6 m
E5	U 5050/300 E5L	300	965977	67,37	1 p.
E5	U 5050/400 E5L	400	965984	89,82	1 p.
E5	U 5050/500 E5L	500	965991	112,28	1 p.
E5	U 5050/600 E5L	600	966004	134,73	1 p.
E5	U 5050/800 E5L	800	966011	179,64	1 p.
E5	U 5050/1000 E5L	1000	966028	224,55	1 p.
E5	U 5050/6000 E5L	6000	966035	224,55	6 m

for the manufacturing of ceiling supports and supporting systems made of different elements

Serie of oblong holes (13x40 mm) on 3 profile sides

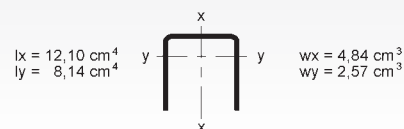
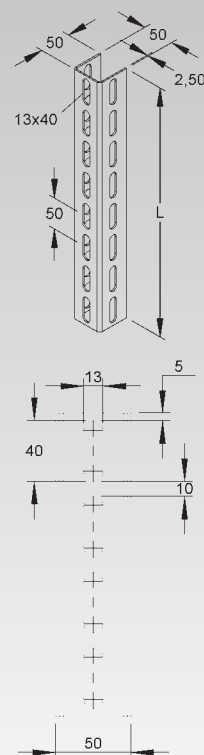

Profile U 5050

epoxy

Item ref.	RAL colour	Length L mm	EAN code	Weight 100 units pc	Min. pack.
C1 U 5050/300 C1KG	7032	300	967384	72,00	1 p.
C1 U 5050/400 C1KG	7032	400	967391	96,00	1 p.
C1 U 5050/500 C1KG	7032	500	967407	120,00	1 p.
C1 U 5050/600 C1KG	7032	600	967414	144,00	1 p.
C1 U 5050/700 C1KG	7032	700	967421	168,00	1 p.
C1 U 5050/800 C1KG	7032	800	967438	192,00	1 p.
C1 U 5050/900 C1KG	7032	900	967445	216,00	1 p.
C1 U 5050/1000 C1KG	7032	1000	967339	128,33	1 p.
C1 U 5050/1100 C1KG	7032	1100	967346	141,17	1 p.
C1 U 5050/1200 C1KG	7032	1200	967353	154,00	1 p.
C1 U 5050/1500 C1KG	7032	1500	967360	359,00	1 p.
C1 U 5050/2000 C1KG	7032	2000	967377	229,73	1 m

for the manufacturing of ceiling supports and supporting systems made of different elements

Serie of oblong holes (13x40 mm) on 3 profile sides

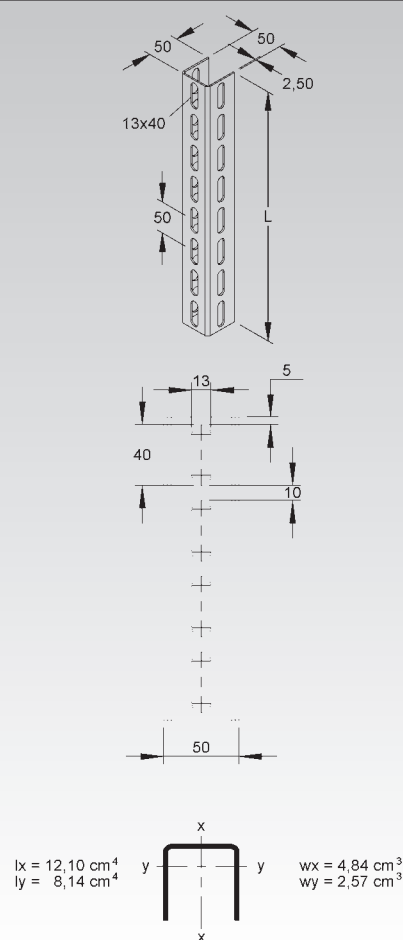

Anchor fixing plate included bolts

Item ref.	Total length L mm	thickness of top plates (th) mm	Accessories/ bolts included	EAN code	Weight 100 units pc./	Min. pack.
F KU 5050	105	5	2 FLM 10x25 F	191956	76,85	1 p.
E5 KU 5050 E5	105	5	2 FLM 10x25 E5	967322	78,75	1 p.

for the mounting on straight ceilings

Used for: Profile U 5050/...

Serie of oblong holes (13x40 mm) on 3 profile sides

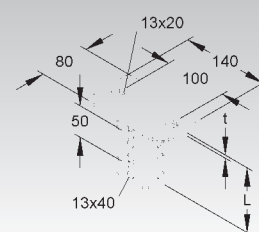

Anchor fixing plate included bolts

epoxy

Item ref.	RAL colour	Total length L mm	thickness of top plates (th) mm	Accessories/ bolts included	EAN code	Weight 100 units pc	Min. pack.
C1 KU 5050 C1KG	7032	105	5	2 SKM 10x25 E5	967315	72,7	1 p.

for the mounting on straight ceilings

Used for: Profile U 5050/... C1KG

Serie of oblong holes (13x40 mm) on 3 profile sides

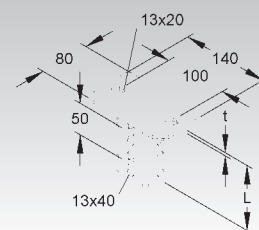

SUPPORT SYSTEM

Ceiling support

pultruded, C-profile

Item ref.	RAL colour	Length L mm	Admissible load F in traction kN	EAN code	Weight 100 units pc	Min. pack.
K23 FPES 200/AC	7032	200	1,5	955923	75	1 p.
K23 FPES 300/AC	7032	300	1,5	955930	92	1 p.
K23 FPES 400/AC	7032	400	1,5	955947	110	1 p.
K23 FPES 500/AC	7032	500	1,5	955954	127	1 p.

for a mounting on 1 side of the support

Total length = L + 53 millimeters

The ceiling support fixing to the ceiling with screws require the use of a large washer, to be ordered separately

Used for: Bracket FPAP.../AC and FPAM.../AC

Other lengths are available on request

Mounting accessories required : FPBGV10 V4A (to be ordered separately)

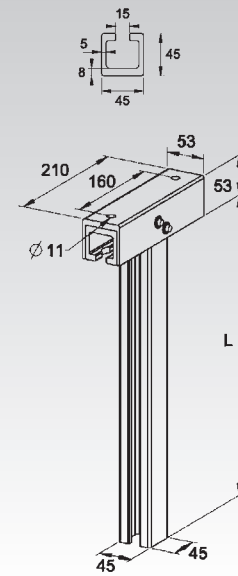

Ceiling support

pultruded, double C-profile

Item ref.	RAL colour	Length L mm	Admissible load F in traction kN	EAN code	Weight 100 units pc	Min. pack.
K23 FPDS 200/AC	7032	200	2 x 1,5	955886	76	1 p.
K23 FPDS 300/AC	7032	300	2 x 1,5	955893	96	1 p.
K23 FPDS 400/AC	7032	400	2 x 1,5	955909	175	1 p.
K23 FPDS 500/AC	7032	500	2 x 1,5	955916	205	1 p.

to mount on the both support sides

Total length = L + 53 millimeters

The ceiling support fixing to the ceiling with screws require the use of a large washer, to be ordered separately

Used for: Bracket FPAP.../AC and FPAM.../AC

Other lengths are available on request

Mounting accessories required : FPBGV10 V4A (to be ordered separately)

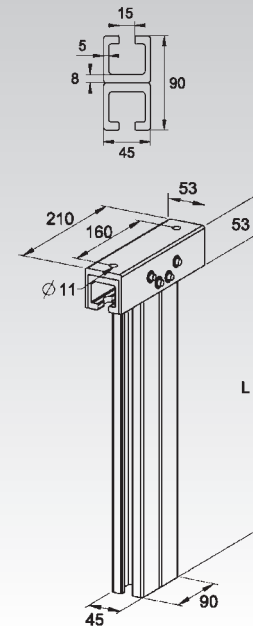

Anchor bolt

Item ref.	Length L mm	EAN code	Weight 100 units pc	Min. pack.
E4 FPBGV 10 E4	30	962662	6,6	25 p.

for fixing the cables on the C profile

Used for: Bracket FPAP/AC, FPAM/AC and FPAR/AC

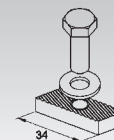

GRP fixing rail

pultruded, C-profile, slot width 15 mm, perforated

Item ref.	RAL colour	Length L mm	Admissible load F in traction kN	EAN code	Weight 100 units pc	Min. pack.
K23 FPAR 500/AC	7032	500	1,5	955961	52	1 p.
K23 FPAR 750/AC	7032	750	1,5	955978	76	1 p.
K23 FPAR 1000/AC	7032	1000	1,5	955985	168	1 p.
K23 FPAR 2000/AC	7032	2000	1,5	955992	244	1 p.

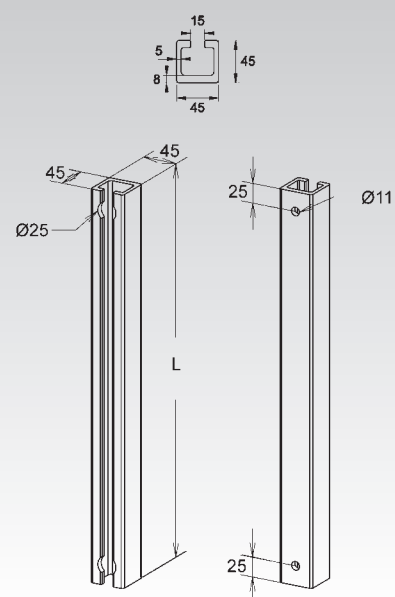

System
K²

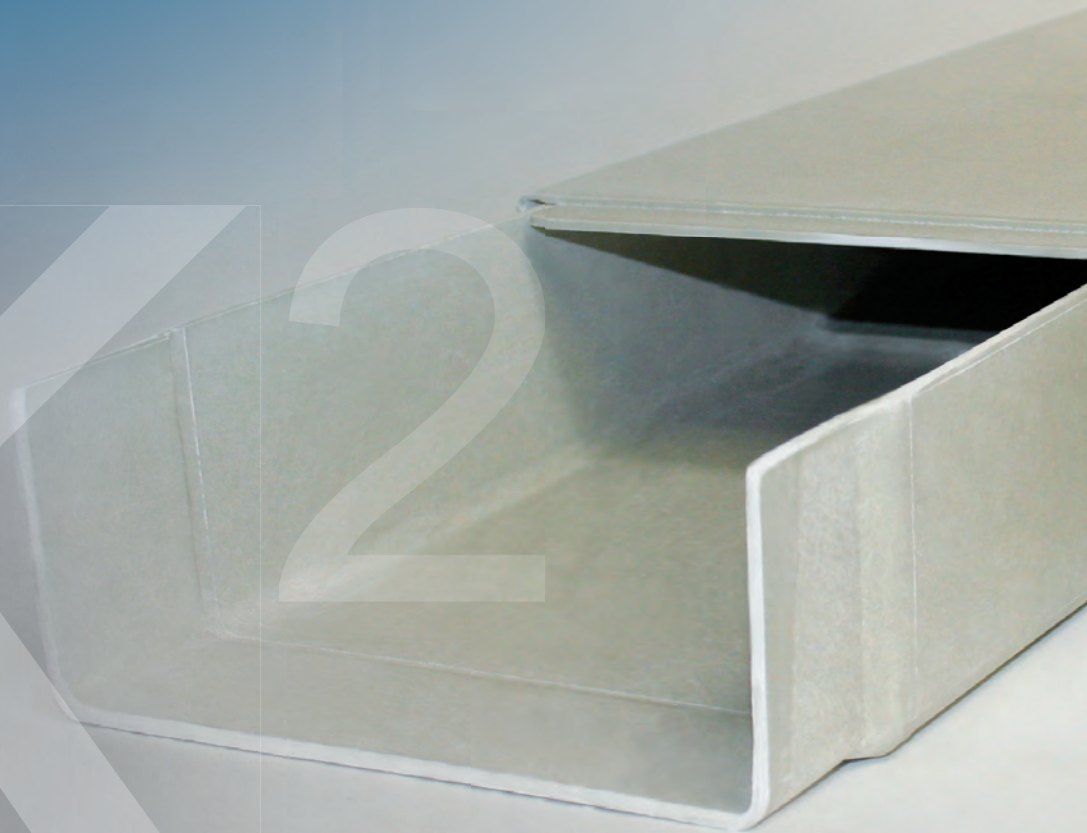

Cable tray systems available in height    

Cable trays

Dividers

Fittings

Covers



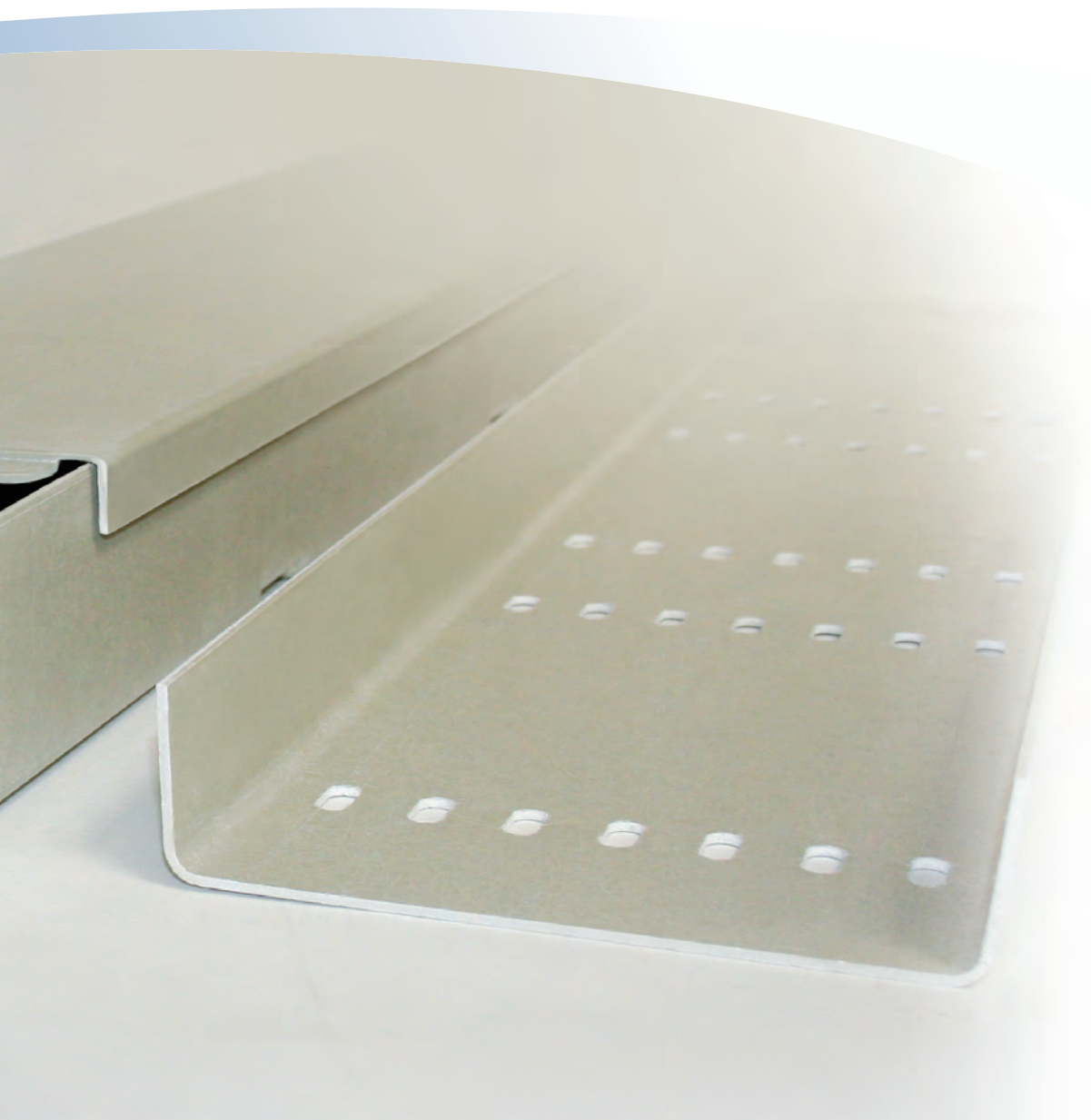



























































Accessoires



The cable tray system K² EBO Systems (hot press moulding) offers the widest and most complete range of the GRP market. Its unique interlocking and self-adjusting couplers allows a screwless connection between the cable tray lengths, and a support distance of up to 1.5 m.

CABLE TRAY SYSTEM K²

Available siderail heights

SYSTEM	GRP-Cable tray, pressed, perforated	KKL	 30	 30	 35	 40
	GRP-Cable tray, pressed, not perforated	KK	 30	 30	 35	 40
ACCESSORIES	GRP-Encap, pressed	KKKE	 —	 30	 35	 40
	GRP-Splice plate, pressed, horizontal	KKGH	 —	 31	 35	 40
	STAINLESS STEEL-Splice plate-horizontal	KKIH	 —	 31	 36	 41
	GRP-Divider, pressed	KKT...	 —	 31	 36	 41
	GRP-T, pressed, small radius	KKSS	 —	 31	 36	 —
	GRP-T, pressed, big radius	KKST	 —	 31	 36	 41
	GRP-Elbow 45°, pressed, horizontal	KKC	 —	 32	 37	 41
	GRP-Elbow 90°, pressed, big radius	KKB	 —	 32	 37	 42
	GRP-Elbow 90°, pressed, small radius	KKW	 —	 32	 37	 41
	GRP-Reducer, pressed, right	KKRR	 —	 32	 37	 42
	GRP-Reducer, pressed, left	KKRL	 —	 32	 38	 42
	GRP-Splice plate, vertical	KKGV	 —	 33	 38	 42
	STAINLESS STEEL-Splice plate, vertical	KKIV	 —	 33	 38	 42
	GRP-Changing elevation	KKET	 —	 33	 38	 43
	GRP-Inside elbow 90°, pressed	KKBI	 —	 33	 39	 43
	GRP-Outside elbow 90°, pressed	KKBA	 —	 34	 39	 43
	GRP-Mounting plate, pressed	MP	 —	 34	 39	 44
	Cover clip	DF...	50/51			
	Separating stud	TB	52*			
	Dome head bolt	FKM	52*			
	Hexagon head bolt	SKM	52*			
 NEW	Cover fixing insert	DF M	50*			
	Cover clip	DFUB	52*			

Covers for cables ladders UL systems are available from page 46.

* suitable for all heights

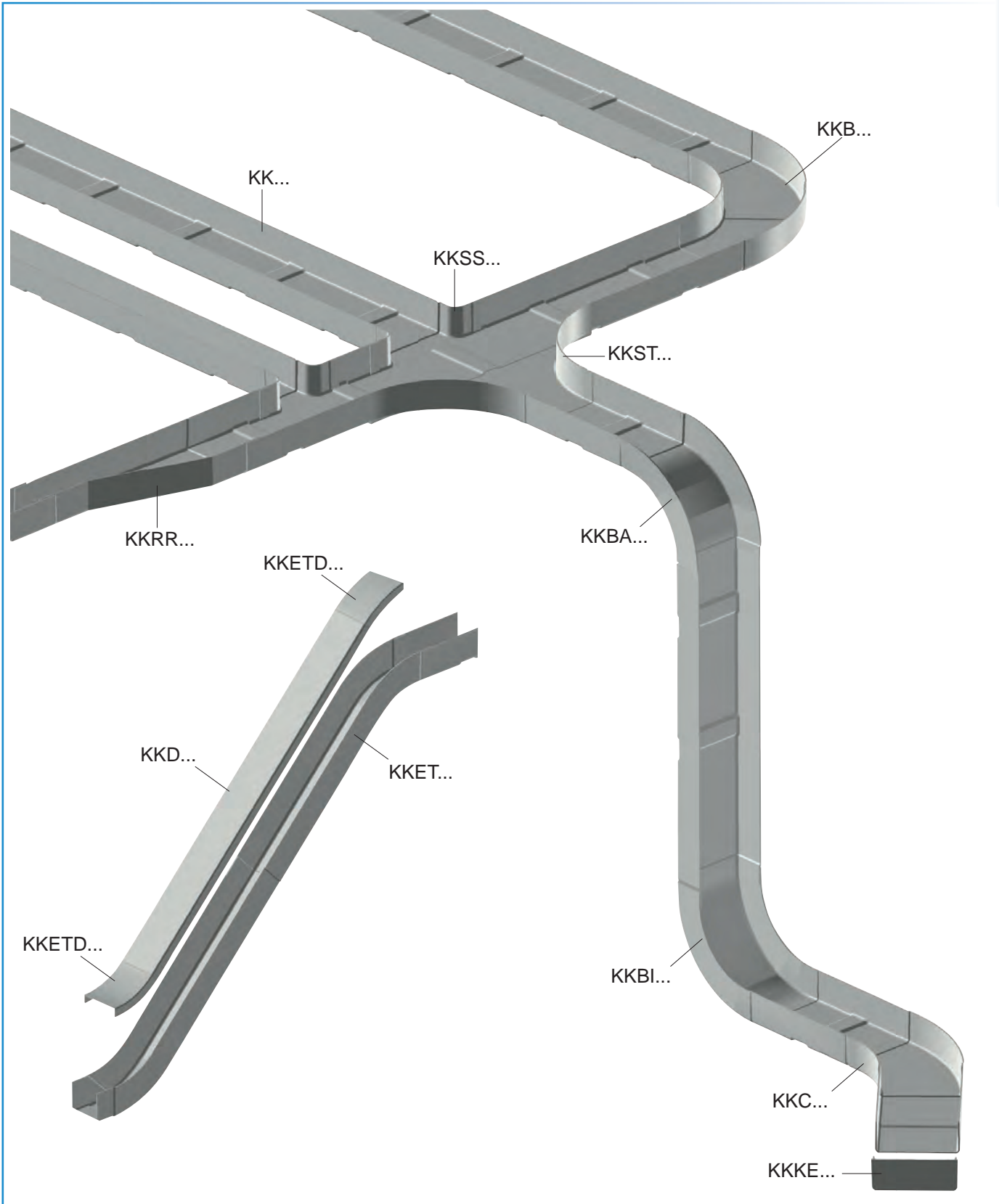

CABLE TRAY SYSTEM K²

GRP cable trays

pressed, perforated, equipped with a shaped coupler

Item ref.	RAL colour	Height	Width B	Material thickness (th)	Operating cross cut	EAN code	Weight 100 units m	Min. pack.
		mm	mm	mm	mm ²			
K23 KKL 20.050	7032	20	50	3	830	952205	47	3 m

The splice plates KKGH must be fixed on the base.

Due to the expansion of the material, the following points during installation must be observed: Please take into account an expansion joint of 8 mm for dilatation.

For fixing the cables trays on brackets, you need to drill a 9 mm diameter hole for the fixing of the cable tray base with bolts M6x20 V4A.

Warning: the deflection is measured with a junction position between 2 cable trays at a distance L/5 from the support. If this distance is not respected, it is necessary to raise the deflection values by approx. 30%.

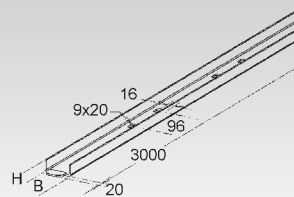

GRP cable trays

pressed, not perforated, with interlocking coupler,

Item ref.	RAL colour	Height	Width B	Material thickness (th)	Operating cross cut	EAN code	Weight 100 units m	Min. pack.
		mm	mm	mm	mm ²			
K23 KK 20.050	7032	20	50	3	830	952007	47	3 m

The splice plates KKGH must be fixed on the base

Due to the expansion of the material, the following points during installation must be observed: Please take into account an expansion joint of 8 mm for dilatation. For the fixing of cable trays on brackets, a 9 mm diameter hole must be drilled in the cable tray base to fix them with bolts M6x20 V4A.

Warning: the deflection is measured with a junction position between 2 cable trays at a distance L/5 from the support. If this distance is not respected, it is necessary to raise the deflection values by approx. 30%.

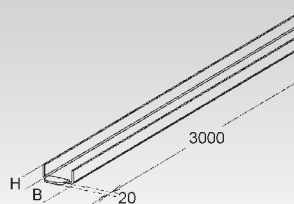

GRP cable trays

pressed, perforated, equipped with a shaped coupler

Item ref.	RAL colour	Height	Width B	Admissible load F at L=1,5 m	Material thickness (th)	Operating cross cut	EAN code	Weight 100 units m	Min. pack.
		mm	mm	kN/m	mm	mm ²			
K23 KKL 50.050	7032	50	50	0,05	3	1500	952212	66,4	3 m
K23 KKL 50.100	7032	50	100	0,3	3	3700	952229	94,6	3 m
K23 KKL 50.150	7032	50	150	0,3	3	5900	952236	128,0	3 m
K23 KKL 50.200	7032	50	200	0,3	3	8100	952243	137,4	3 m
K23 KKL 50.300	7032	50	300	0,3	3	12500	952250	210,0	3 m

Warning: the deflection is measured with a junction position between 2 cable trays at a distance L/5 from the support. If this distance is not respected, it is necessary to raise the deflection values by approx. 30%.

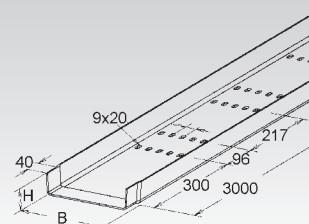

GRP cable trays

pressed, not perforated, with interlocking coupler

Item ref.	RAL colour	Height	Width B	Admissible load F at L=1,5 m	Material thickness (th)	Operating cross cut	EAN code	Weight 100 units m	Min. pack.
		mm	mm	kN/m	mm	mm ²			
K23 KK 50.050	7032	50	50	0,05	3	1500	952014	70	3 m
K23 KK 50.100	7032	50	100	0,3	3	3700	952021	98	3 m
K23 KK 50.150	7032	50	150	0,3	3	5900	952038	125	3 m
K23 KK 50.200	7032	50	200	0,3	3	8100	952045	152	3 m
K23 KK 50.300	7032	50	300	0,3	3	12500	952052	210	3 m

Warning: the deflection is measured with a junction position between 2 cable trays at a distance L/5 from the support. If this distance is not respected, it is necessary to raise the deflection values by approx. 30%.

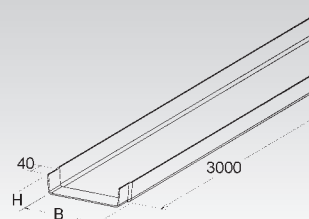

End cap for GRP cable tray

pressed

Item ref.	RAL colour	Height	Width B	EAN code	Weight 100 units pc	Min. pack.
		mm	mm			
K23 KKKE 50.050	7032	50	50	955190	2,0	1 p.
K23 KKKE 50.100	7032	50	100	955206	6,0	1 p.
K23 KKKE 50.150	7032	50	150	955213	4,0	1 p.
K23 KKKE 50.200	7032	50	200	955220	11,5	1 p.
K23 KKKE 50.300	7032	50	300	955237	17,0	1 p.

for the closing of the cable tray ends

Used for: Cable trays KK..., KKL... H50 mm

Mounting accessories required: 2 bolts M6x16 V4A (to be ordered separately)

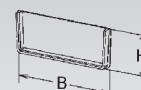

GRP adjustable splice plate

pressed, horizontal

Item ref.	RAL colour	Height mm	EAN code	Weight 100 units	Min. pack.
K23 KKGH 50	7032	35	955626	2,4	1 set

for the horizontal connection of cable trays and fittings H50 mm lengthwise

Need: 2 pieces for each cut

for the cable tray connection with an expansion joint

Mounting accessories required : 4 bolts M6x20 V4A (to be ordered separately)

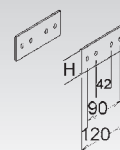

Horizontal splice plate

horizontal

Item ref.	Height mm	EAN code	Weight 100 units	Min. pack.
E4 KKIH 50 E4	38	955657	1,4	1 set

for the horizontal connection of cable trays and fittings H50 mm and for the changes of directions.

Need: 2 pieces for each cut

for the length adjustment, please leave a space between cable trays.

Mounting accessories required : 4 bolts M6x16 V4A (to be ordered separately)

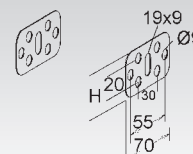

GRP separator

pressed

Item ref.	RAL colour	Height mm	EAN code	Weight 100 units m	Min. pack.
K23 KKT 50	7032	42	953028	38	3 m
K23 KKT 50/M	7032	42	953059	38	3 m

to separate cables with different functions and / or to separate voltages

The divider **KKT 50** is delivered not mounted, it can be fixed in the cable tray with a bolt **M 6x16 V4A** each meter.

The divider **KKT50/M** can be delivered pre-mounted (riveted), the position inside the cable tray must be defined in the purchase order.

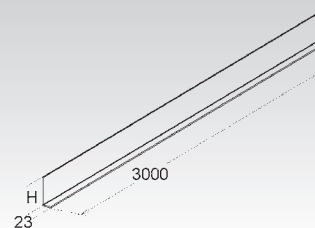

GRP tee junction for cable tray, small radius

pressed, with interlocking coupler

Item ref.	RAL colour	Height mm	Width B mm	EAN code	Weight 100 units pc	Min. pack.
K23 KKSS 50.050	7032	50	50	954780	15	1 p.
K23 KKSS 50.100	7032	50	100	954797	10	1 p.
K23 KKSS 50.150	7032	50	150	954803	20	1 p.
K23 KKSS 50.200	7032	50	200	954810	25	1 p.
K23 KKSS 50.300	7032	50	300	954827	30	1 p.

During the installation, you must take care to position a support at each cable tray end and to fix them with bolts M 6x16 V4A.

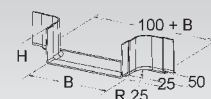

GRP tee junction for cable tray, large radius

pressed, with interlocking coupler

Item ref.	RAL colour	Height mm	Width B mm	EAN code	Weight 100 units pc	Min. pack.
K23 KKST 50.100	7032	50	100	954575	60,0	1 p.
K23 KKST 50.150	7032	50	150	954582	67,7	1 p.
K23 KKST 50.200	7032	50	200	954599	76,6	1 p.
K23 KKST 50.300	7032	50	300	954605	100,0	1 p.

During the assembly, every fitting must be supported at each end, at the cable entry.

To ensure a correct installation, the couplers must be fixed laterally by 4 bolts M6x16 V4A on each tray end.

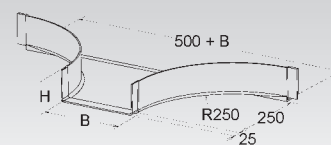

CABLE TRAY SYSTEM K²

Horizontal elbow 45°

pressed, with interlocking coupler

Item ref.	RAL colour	Height	Width B	Radius R	EAN code	Weight 100 units pc	Min. pack.
		mm	mm	mm			
K23 KKC 50.100	7032	50	100	100	953400	20	1 p.
K23 KKC 50.150	7032	50	150	175	953417	25	1 p.
K23 KKC 50.200	7032	50	200	200	953424	30	1 p.
K23 KKC 50.300	7032	50	300	225	953431	60	1 p.

The piece is provided with a sleeve riveted on one side only.

To ensure a correct installation, the couplers must be fixed laterally by 2 bolts M6x16 V4A on each tray end.

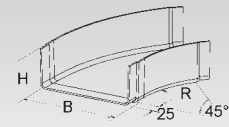

Horizontal elbow 90°, small radius

pressed, with interlocking coupler

Item ref.	RAL colour	Height	Width B	EAN code	Weight 100 units pc	Min. pack.
		mm	mm			
K23 KKW 50.050	7032	50	50	953646	10	1 p.
K23 KKW 50.100	7032	50	100	953653	21	1 p.
K23 KKW 50.150	7032	50	150	953660	35	1 p.
K23 KKW 50.200	7032	50	200	953677	40	1 p.
K23 KKW 50.300	7032	50	300	953684	80	1 p.

During the assembly, every fitting must be supported at each end, at the cable entry.

To ensure a correct installation, the couplers must be fixed laterally by 2 bolts M6x16 V4A on each tray end.

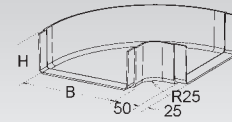

Horizontal elbow 90°, large radius

pressed, with interlocking coupler

Item ref.	RAL colour	Height	Width B	C	Radius R	EAN code	Weight 100 units pc	Min. pack.
		mm	mm	mm	mm			
K23 KKB 50.100	7032	50	100	125	100	953165	37,0	1 p.
K23 KKB 50.150	7032	50	150	200	175	953172	60,0	1 p.
K23 KKB 50.200	7032	50	200	225	200	953189	70,0	1 p.
K23 KKB 50.300	7032	50	300	250	225	953196	134,8	1 p.

During the assembly, we recommend to support each end of fitting at each cable entry.

To ensure a correct installation, the couplers must be fixed laterally by 2 bolts M6x16 V4A on each tray end.

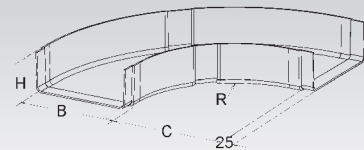

GRP right hand reduction

pressed, with interlocking coupler

Item ref.	RAL colour	Height	Width B	EAN code	Weight 100 units pc	Min. pack.
		mm	mm			
K23 KKRR 50.200	7032	50	200	955022	90	1 p.
K23 KKRR 50.300	7032	50	300	955039	114	1 p.

During the assembly, every reducer must be supported at each end.

To ensure a correct installation, the couplers must be fixed laterally by 2 bolts M6x16 V4A on each tray end.

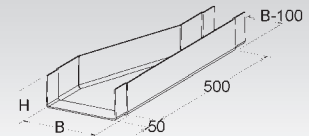

GRP left hand reduction

pressed, with interlocking coupler

Item ref.	RAL colour	Height	Width B	EAN code	Weight 100 units pc	Min. pack.
		mm	mm			
K23 KKRL 50.200	7032	50	200	954919	90	1 p.
K23 KKRL 50.300	7032	50	300	954926	114	1 p.

During the assembly, every reducer must be supported at each end.

To ensure a correct installation, the couplers must be fixed laterally by 2 bolts M6x16 V4A on each tray end.

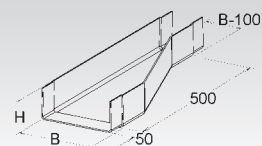

GRP vertical splice plate

pressed, horizontal

Item ref.	RAL colour	Height mm	EAN code	Weight 100 units	Min. pack.
K23 KKGV 50	7032	35	955138	5	1 set

for the vertical connection of cable trays and fittings H50 with an angle adjustment.

Need: 2 pieces for each cut

Mounting accessories required : 4 bolts M6x20 V4A (to be ordered separately)

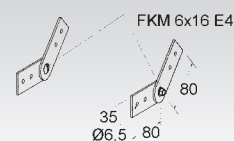

Stainless steel vertical splice plate V4A

vertical

Item ref.	Height mm	EAN code	Weight 100 units	Min. pack.
E4 KKIV 50 E4	38	955169	3	1 set

for the horizontal connection of cable trays and fittings H50 mm and for the changes of directions.

Need: 2 pieces for each cut

Mounting accessories required : 4 bolts M6x16 V4A (to be ordered separately)

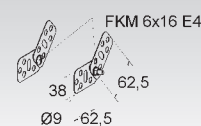

GRP changing elevation

pressed, with interlocking coupler

Item ref.	RAL colour	Height mm	Width B mm	Height H1 mm	Height H2 mm	Height H3 mm	EAN code	Weight 100 units pc	Min. pack.
K23 KKET 50.100	7032	50	100	160	480	800	954339	210	1 p.
K23 KKET 50.150	7032	50	150	160	480	800	954346	216	1 p.
K23 KKET 50.200	7032	50	200	160	480	800	954353	259	1 p.
K23 KKET 50.300	7032	50	300	160	480	800	954360	263	1 p.

Composed with different pieces, the changing elevation can be mounted in different heights

During the assembly, every fitting must be supported at each end and in the fitting center.

To ensure a correct installation, the couplers must be fixed laterally by 2 bolts M6x16 V4A on each tray end.

The part height depends on the height and the configuration used

H1 = 160 mm => L1 = 785 mm (a cut is necessary)

H2 = 480 mm => L2 = 1100 mm

H3 = 800 mm => L3 = 970 mm

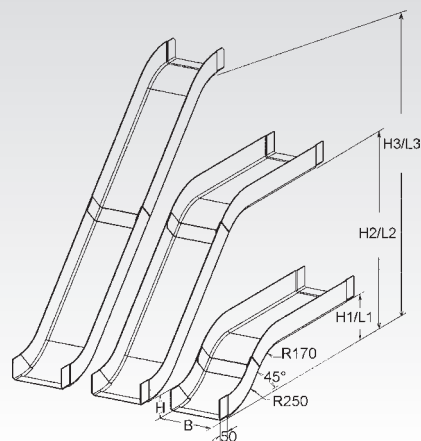
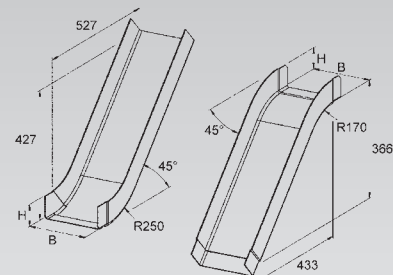

GRP vertical inside elbow

pressed, with interlocking coupler

Item ref.	RAL colour	Height mm	Width B mm	EAN code	Weight 100 units pc	Min. pack.
K23 KKBI 50.050	7032	50	50	954025	11,7	1 p.
K23 KKBI 50.100	7032	50	100	954032	37,5	1 p.
K23 KKBI 50.150	7032	50	150	954049	61,0	1 p.
K23 KKBI 50.200	7032	50	200	954056	77,0	1 p.
K23 KKBI 50.300	7032	50	300	954063	90,9	1 p.

During the assembly, we recommend to support each end of fitting at each cable entry.

Mounting accessories required : 2 bolts M6x16 V4A (to be ordered separately)

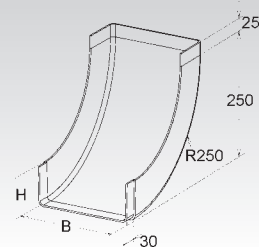

CABLE TRAY SYSTEM K²

GRP vertical outside elbow

pressed, with interlocking coupler

Item ref.	RAL colour	Height	Width B	EAN code	Weight 100 units pc	Min. pack.
		mm	mm			
K23 KKBA 50.050	7032	50	50	953837	11,5	1 p.
K23 KKBA 50.100	7032	50	100	953844	32,0	1 p.
K23 KKBA 50.150	7032	50	150	953851	34,9	1 p.
K23 KKBA 50.200	7032	50	200	953868	51,0	1 p.
K23 KKBA 50.300	7032	50	300	953875	74,0	1 p.

During the assembly, we recommend to support each end of fitting at each cable entry.
To ensure a correct installation, the couplers must be fixed laterally by 2 bolts M6x16 V4A on each tray end.

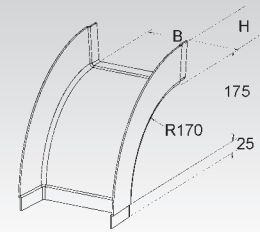

Mounting plate

pressed, easy to install, with pre-mounted fixing clamps

Item ref.	RAL colour	Height	EAN code	Weight 100 units pc	Min. pack.
		mm			
E4 K23 MP 50	7032	50	963010	17	1 p.

for the installation of equipment or junction boxes

The mounting plate is in GRP, only the mounting lug are in stainless steel V4A

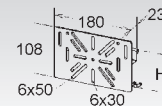

GRP cable trays

pressed, perforated, equipped with a shaped coupler, with reinforced sidewalls (5 mm)

Item ref.	RAL colour	Height	Width B	Admissible load F at L=1,5 m	Material thickness (th)	Operating cross cut	EAN code	Weight 100 units m	Min. pack.	
		mm	mm	kN/m	mm	mm ²				
K23	KKL 80.100	7032	80	100	0,5	3	6500	952267	122,0	3 m
K23	KKL 80.150	7032	80	150	0,5	3	10200	952274	161,0	3 m
K23	KKL 80.200	7032	80	200	0,5	3	13900	952281	180,0	3 m
K23	KKL 80.250	7032	80	250	0,5	3	17600	952298	218,7	3 m
K23	KKL 80.300	7032	80	300	0,5	3	21300	952304	281,0	3 m
K23	KKL 80.400	7032	80	400	1,0	4	27600	952311	380,0	3 m
K23	KKL 80.500	7032	80	500	1,0	4	34800	952328	480,0	3 m
K23	KKL 80.600	7032	80	600	1,0	4	42000	952335	540,0	3 m

Thanks to the cable trays' straps it can be used for high frequency according to UTEC15-900 (classe D, frequency 16 MHz).

L = support distance (in m)

Warning : the deflection is measured with a junction position between 2 cable trays at a distance L/5 from the support. If this distance is not respected, it is necessary to raise the deflection values by approx. 30%.

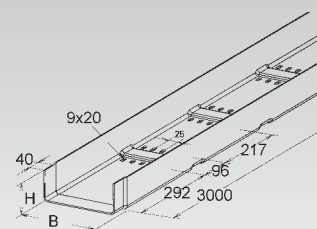

GRP cable trays

pressed, equipped with a shaped coupler, with reinforced sidewalls (5 mm)

Item ref.	RAL colour	Height	Width B	Admissible load F at L=1,5 m	Material thickness (th)	Operating cross cut	EAN code	Weight 100 units m	Min. pack.	
		mm	mm	kN/m	mm	mm ²				
K23	KK 80.100	7032	80	100	0,5	3	6500	952069	127	3 m
K23	KK 80.150	7032	80	150	0,5	3	10200	952076	165	3 m
K23	KK 80.200	7032	80	200	0,5	3	13900	952083	195	3 m
K23	KK 80.250	7032	80	250	0,5	3	17600	952090	220	3 m
K23	KK 80.300	7032	80	300	0,5	3	21300	952106	230	3 m
K23	KK 80.400	7032	80	400	1,0	4	27600	952113	390	3 m
K23	KK 80.500	7032	80	500	1,0	4	34800	952120	460	3 m
K23	KK 80.600	7032	80	600	1,0	4	42000	952137	470	3 m

Thanks to the cable trays' straps it can be used for high frequency according to UTEC15-900 (classe D, frequency 16 MHz).

L = support distance (in m)

Warning : the deflection is measured with a junction position between 2 cable trays at a distance L/5 from the support. If this distance is not respected, it is necessary to raise the deflection values by approx. 30%.

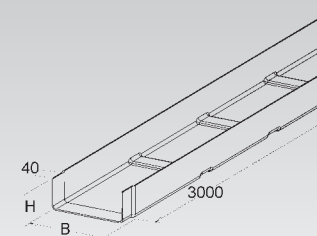

End cap for GRP cable tray

pressed

Item ref.	RAL colour	Height	Width B	EAN code	Weight 100 units pc	Min. pack.	
		mm	mm				
K23	KKKE 80.100	7032	80	100	955244	6,0	1 p.
K23	KKKE 80.150	7032	80	150	955251	9,0	1 p.
K23	KKKE 80.200	7032	80	200	955268	12,0	1 p.
K23	KKKE 80.250	7032	80	250	955275	14,0	1 p.
K23	KKKE 80.300	7032	80	300	955282	17,5	1 p.
K23	KKKE 80.400	7032	80	400	955299	21,0	1 p.
K23	KKKE 80.500	7032	80	500	955305	26,0	1 p.
K23	KKKE 80.600	7032	80	600	955312	35,0	1 p.

for the closing of the cable tray ends

Used for: Cable trays KK..., KKL... H80 mm

Mounting accessories required : 2 bolts M6x16 V4A (to be ordered separately)

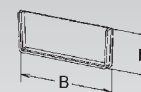

GRP adjustable splice plate

pressed, horizontal

Item ref.	RAL colour	Height	EAN code	Weight 100 units	Min. pack.
		mm			
K23	KKGH 80	7032	955633	3,7	1 set

for the horizontal connection of cable trays and fittings H80mm lengthwise

Need: 2 pieces for each cut

for the cable tray connection with an expansion joint

Mounting accessories required : 4 bolts M6x16 V4A (to be ordered separately)

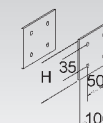

CABLE TRAY SYSTEM K²

Horizontal splice plate

horizontal

Item ref.	RAL colour	Height mm	EAN code	Weight 100 units	Min. pack.
E4 KKIH 80 E4	7032	65	955664	3,6	1 set

for the horizontal connection of cable trays and fittings H80 mm and for the changes of directions.

Need: 2 pieces for each cut

for the length adjustment, please leave a space between cable trays.

Mounting accessories required : 4 bolts M6x16 V4A (to be ordered separately)

80

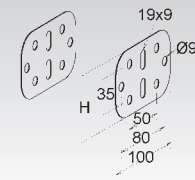

GRP separator

pressed

Item ref.	RAL colour	Height mm	EAN code	Weight 100 units m	Min. pack.
K23 KKT 80	7032	67	953035	40	3 m
K23 KKT 80/M	7032	67	953066	40	3 m

to separate cables with different functions and / or to separate voltages

The divider KKT 80 is delivered not mounted, it can be fixed in the cable tray with a bolt M 6x16 V4A each meter.

The divider KKT80/M can be delivered pre-installed (riveted), the position inside the cable tray must be defined in the purchase order.

80

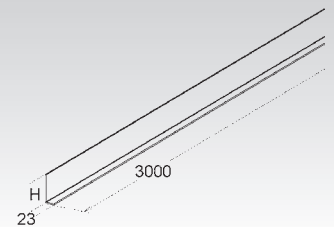

GRP tee junction for cable tray, small radius

pressed, with interlocking coupler

Item ref.	RAL colour	Height mm	Width B mm	EAN code	Weight 100 units pc	Min. pack.
K23 KKSS 80.100	7032	80	100	954834	18	1 p.
K23 KKSS 80.150	7032	80	150	954841	27	1 p.
K23 KKSS 80.200	7032	80	200	954858	22	1 p.
K23 KKSS 80.250	7032	80	250	954865	28	1 p.
K23 KKSS 80.300	7032	80	300	954872	32	1 p.

During the installation, you must take care to position a support at each cable tray end and to fix them with bolts M 6x16 V4A.

80

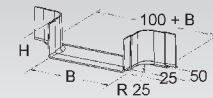

GRP tee junction for cable tray, large radius

pressed, with interlocking coupler

Item ref.	RAL colour	Height mm	Width B mm	EAN code	Weight 100 units pc	Min. pack.
K23 KKST 80.100	7032	80	100	954612	78,0	1 p.
K23 KKST 80.150	7032	80	150	954629	88,0	1 p.
K23 KKST 80.200	7032	80	200	954636	90,0	1 p.
K23 KKST 80.250	7032	80	250	954643	101,0	1 p.
K23 KKST 80.300	7032	80	300	954650	108,5	1 p.
K23 KKST 80.400	7032	80	400	954667	130,0	1 p.
K23 KKST 80.500	7032	80	500	954674	145,0	1 p.
K23 KKST 80.600	7032	80	600	954681	164,0	1 p.

During assembly, all the fittings must be supported at every cables entry, add a centrale support for all fittings with radius greater than 250 mm, and/or with width greater than 400 mm

To ensure a correct installation, the couplers must be fixed laterally by 4 bolts M6x16 V4A on each tray end.

80

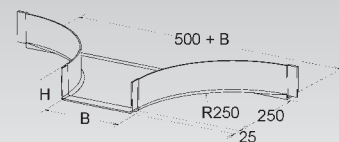

Horizontal elbow 45°

pressed, with interlocking coupler

Item ref.	RAL colour	Height	Width B	Radius R	EAN code	Weight 100 units pc	Min. pack.
		mm	mm	mm			
K23 KKC 80.100	7032	80	100	100	953448	22,0	1 p.
K23 KKC 80.150	7032	80	150	175	953455	29,5	1 p.
K23 KKC 80.200	7032	80	200	200	953462	50,0	1 p.
K23 KKC 80.250	7032	80	250	275	953479	70,0	1 p.
K23 KKC 80.300	7032	80	300	225	953486	100,0	1 p.
K23 KKC 80.400	7032	80	400	250	953493	151,0	1 p.
K23 KKC 80.500	7032	80	500	250	953509	280,0	1 p.
K23 KKC 80.600	7032	80	600	250	953516	300,0	1 p.

The piece is provided with a sleeve riveted on one side only.

During assembly, all the fittings must be supported at every cables entry, add a centrale support for all fittings with radius greater than 250 mm, and/or with width greater than 400 mm

To ensure a correct installation, the couplers must be fixed laterally by 2 bolts M6x16 V4A on each tray end.

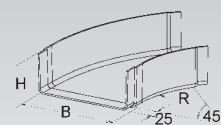

Horizontal elbow 90°, small radius

pressed, with interlocking coupler

Item ref.	RAL colour	Height	Width B	EAN code	Weight 100 units pc	Min. pack.
		mm	mm			
K23 KKW 80.100	7032	80	100	953691	27	1 p.
K23 KKW 80.150	7032	80	150	953707	35	1 p.
K23 KKW 80.200	7032	80	200	953714	53	1 p.
K23 KKW 80.250	7032	80	250	953721	62	1 p.
K23 KKW 80.300	7032	80	300	953738	86	1 p.
K23 KKW 80.400	7032	80	400	953745	125	1 p.
K23 KKW 80.500	7032	80	500	953752	195	1 p.
K23 KKW 80.600	7032	80	600	953769	240	1 p.

During assembly, all the fittings must be supported at every cables entry, add a centrale support for all fittings with radius greater than 250 mm, and/or with width greater than 400 mm

To ensure a correct installation, the couplers must be fixed laterally by 2 bolts M6x16 V4A on each tray end.

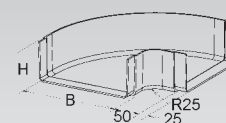

Horizontal elbow 90°, large radius

pressed, with interlocking coupler

Item ref.	RAL colour	Height	Width B	C	Radius R	EAN code	Weight 100 units pc	Min. pack.
		mm	mm	mm	mm			
K23 KKB 80.100	7032	80	100	125	100	953202	41,5	1 p.
K23 KKB 80.150	7032	80	150	200	175	953219	43,5	1 p.
K23 KKB 80.200	7032	80	200	225	200	953226	90,0	1 p.
K23 KKB 80.250	7032	80	250	300	275	953233	146,5	1 p.
K23 KKB 80.300	7032	80	300	250	225	953240	170,0	1 p.
K23 KKB 80.400	7032	80	400	325	250	953257	272,0	1 p.
K23 KKB 80.500	7032	80	500	325	250	953264	377,0	1 p.
K23 KKB 80.600	7032	80	600	325	250	953271	442,0	1 p.

During assembly, all the fittings must be supported at every cables entry, add a centrale support for all fittings with radius greater than 250 mm, and/or with width greater than 400 mm

To ensure a correct installation, the couplers must be fixed laterally by 2 bolts M6x16 V4A on each tray end.

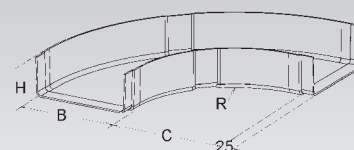

GRP right hand reduction

pressed, with interlocking coupler

Item ref.	RAL colour	Height	Width B	EAN code	Weight 100 units pc	Min. pack.
		mm	mm			
K23 KKRR 80.200	7032	80	200	955046	92	1 p.
K23 KKRR 80.300	7032	80	300	955053	124	1 p.
K23 KKRR 80.400	7032	80	400	955060	165	1 p.
K23 KKRR 80.500	7032	80	500	955077	190	1 p.
K23 KKRR 80.600	7032	80	600	955084	220	1 p.

During the assembly, every reducer must be supported at each end.

To ensure a correct installation, the couplers must be fixed laterally by 2 bolts M6x16 V4A on each tray end.

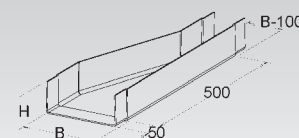

CABLE TRAY SYSTEM K²

GRP left hand reducer

pressed, with interlocking coupler

Item ref.	RAL colour	Height	Width B	EAN code	Weight 100 units pc	Min. pack.
		mm	mm			
K23 KKRL 80.200	7032	80	200	954933	92	1 p.
K23 KKRL 80.300	7032	80	300	954940	114	1 p.
K23 KKRL 80.400	7032	80	400	954957	163	1 p.
K23 KKRL 80.500	7032	80	500	954964	184	1 p.
K23 KKRL 80.600	7032	80	600	954971	220	1 p.

During the assembly, every reducer must be supported at each end.

To ensure a correct installation, the couplers must be fixed laterally by 2 bolts M6x16 V4A on each tray end.

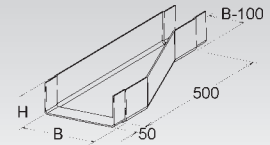

GRP vertical splice plate

pressed, vertical

Item ref.	RAL colour	Height	EAN code	Weight 100 units	Min. pack.
		mm			
K23 KKGV 80	7032	65	955145	9	1 set

for the vertical connection of cable trays and fittings H80 with an angle adjustment.

Need: 2 pieces for each cut

Mounting accessories required : 4 bolts M6x20 V4A (to be ordered separately)

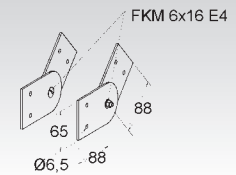

Stainless steel vertical splice plate V4A

vertical

Item ref.	Height	EAN code	Weight 100 units	Min. pack.
	mm			
E4 KKIV 80 E4	65	955176	8	1 set

for the horizontal connection of cable trays and fittings H80 mm and for the changes of directions.

Need: 2 pieces for each cut

Mounting accessories required : 4 bolts M6x16 V4A (to be ordered separately)

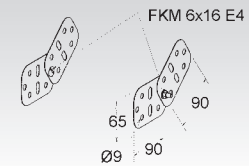

GRP changing elevation

pressed, with interlocking coupler

Item ref.	RAL colour	Height	Width B	Height H1	Height H2	Height H3	EAN code	Weight 100 units pc	Min. pack.
		mm	mm	mm	mm	mm			
K23 KKET 80.100	7032	80	100	160	480	800	954377	190	1 p.
K23 KKET 80.150	7032	80	150	160	480	800	954384	250	1 p.
K23 KKET 80.200	7032	80	200	160	480	800	954391	259	1 p.
K23 KKET 80.250	7032	80	250	160	480	800	954407	340	1 p.
K23 KKET 80.300	7032	80	300	160	480	800	954414	344	1 p.
K23 KKET 80.400	7032	80	400	160	480	800	954421	420	1 p.
K23 KKET 80.500	7032	80	500	160	480	800	954438	500	1 p.
K23 KKET 80.600	7032	80	600	160	480	800	954445	596	1 p.

Composed with different pieces, the changing elevation can be mounted in different heights

During assembly, all the fittings must be supported at every cables entry, add a centrale support for all fittings with radius greater than 250 mm, and/or with width greater than 400 mm

To ensure a correct installation, the couplers must be fixed laterally by 2 bolts M6x16 V4A on each tray end.

The part height depends on the height and the configuration used

H1 = 160 mm => L1 = 785 mm (a cut is necessary)

H2 = 480 mm => L2 = 1100 mm

H3 = 800 mm => L3 = 970 mm

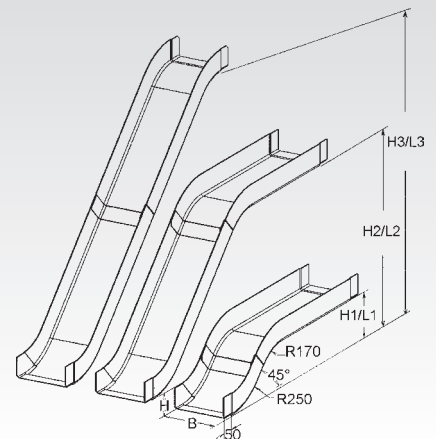
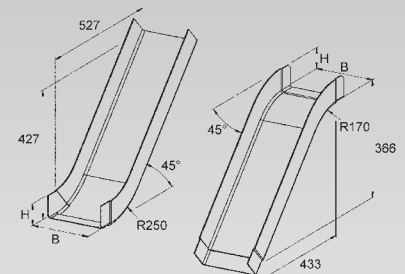

GRP vertical inside elbow

pressed, with interlocking coupler

Item ref.	RAL colour	Height	Width B	EAN code	Weight 100 units pc	Min. pack.
		mm	mm			
K23 KKBI 80.100	7032	80	100	954070	53	1 p.
K23 KKBI 80.150	7032	80	150	954087	64	1 p.
K23 KKBI 80.200	7032	80	200	954094	75	1 p.
K23 KKBI 80.250	7032	80	250	954100	90	1 p.
K23 KKBI 80.300	7032	80	300	954117	102	1 p.
K23 KKBI 80.400	7032	80	400	954124	123	1 p.
K23 KKBI 80.500	7032	80	500	954131	145	1 p.
K23 KKBI 80.600	7032	80	600	954148	170	1 p.

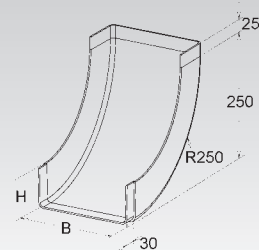

During the assembly, we recommend to support each end of fitting at each cable entry. To ensure a correct installation, the couplers must be fixed laterally by 2 bolts M6x16 V4A on each tray end.

GRP vertical outside elbow

pressed, with interlocking coupler

Item ref.	RAL colour	Height	Width B	EAN code	Weight 100 units pc	Min. pack.
		mm	mm			
K23 KKBA 80.100	7032	80	100	953882	46	1 p.
K23 KKBA 80.150	7032	80	150	953899	55	1 p.
K23 KKBA 80.200	7032	80	200	953905	62	1 p.
K23 KKBA 80.250	7032	80	250	953912	73	1 p.
K23 KKBA 80.300	7032	80	300	953929	74	1 p.
K23 KKBA 80.400	7032	80	400	953936	100	1 p.
K23 KKBA 80.500	7032	80	500	953943	113	1 p.
K23 KKBA 80.600	7032	80	600	953950	134	1 p.

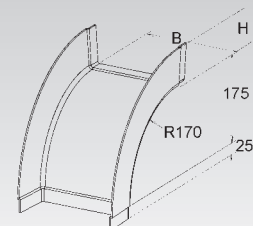

During the assembly, we recommend to support each end of fitting at each cable entry. To ensure a correct installation, the couplers must be fixed laterally by 2 bolts M6x16 V4A on each tray end.

Mounting plate

pressed, easy to install, with pre-mounted fixing clamps

Item ref.	RAL colour	Height	EAN code	Weight 100 units pc	Min. pack.
		mm			
E4 K23 MP 80	7032	80	963027	17	1 p.

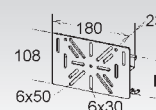

for the installation of equipment or junction boxes

The mounting plate is in GRP, only the mounting lug are in stainless steel V4A

CABLE TRAY SYSTEM K²

GRP cable trays

pressed, perforated, equipped with a shaped coupler, with reinforced sidewalls (5 mm)

Item ref.	RAL colour	Height	Width B	Admissible load F at L=1,5 m	Material thickness (th)	Operating cross cut	EAN code	Weight 100 units m	Min. pack.
		mm	mm	kN/m	mm	mm ²			
K23 KKL 110.100	7032	110	100	1,2	4	8500	952342	230	3 m
K23 KKL 110.200	7032	110	200	1,2	4	18800	952359	300	3 m
K23 KKL 110.300	7032	110	300	1,2	4	29100	952366	370	3 m
K23 KKL 110.400	7032	110	400	1,2	4	39400	952373	440	3 m
K23 KKL 110.500	7032	110	500	1,2	4	49700	952380	510	3 m
K23 KKL 110.600	7032	110	600	1,2	4	60000	952397	580	3 m

Thanks to the cable trays' straps it can be used for high frequency according to UTEC15-900 (classe D, frequency 16 MHz).

L = support distance (in m)

Warning : the deflection is measured with a junction position between 2 cable trays at a distance L/5 from the support. If this distance is not respected, it is necessary to raise the deflection values by approx. 30%.

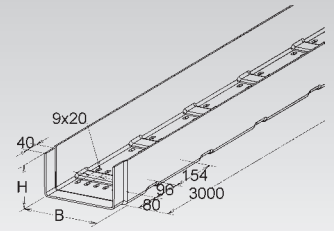

GRP cable trays

pressed, equipped with a shaped coupler, with reinforced sidewalls (5 mm)

Item ref.	RAL colour	Height	Width B	Admissible load F at L=1,5 m	Material thickness (th)	Operating cross cut	EAN code	Weight 100 units m	Min. pack.
		mm	mm	kN/m	mm	mm ²			
K23 KK 110.100	7032	110	100	1,2	4	8500	952144	230	3 m
K23 KK 110.200	7032	110	200	1,2	4	18800	952151	300	3 m
K23 KK 110.300	7032	110	300	1,2	4	29100	952168	380	3 m
K23 KK 110.400	7032	110	400	1,2	4	39400	952175	450	3 m
K23 KK 110.500	7032	110	500	1,2	4	49700	952182	520	3 m
K23 KK 110.600	7032	110	600	1,2	4	60000	952199	600	3 m

Thanks to the cable trays' straps it can be used for high frequency according to UTEC15-900 (classe D, frequency 16 MHz).

L = support distance (in m)

Warning : the deflection is measured with a junction position between 2 cable trays at a distance L/5 from the support. If this distance is not respected, it is necessary to raise the deflection values by approx. 30%.

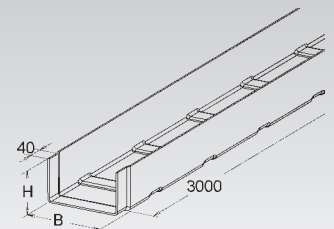

End cap for GRP cable tray

pressed

Item ref.	RAL colour	Height	Width B	EAN code	Weight 100 units pc	Min. pack.
		mm	mm			
K23 KKKE 110.100	7032	110	100	955329	10	1 p.
K23 KKKE 110.200	7032	110	200	955336	13	1 p.
K23 KKKE 110.300	7032	110	300	955343	18	1 p.
K23 KKKE 110.400	7032	110	400	955350	22	1 p.
K23 KKKE 110.500	7032	110	500	955367	27	1 p.
K23 KKKE 110.600	7032	110	600	955374	26	1 p.

for the closing of the cable tray ends

Used for: Cable trays KK..., KKL... H110 mm

Mounting accessories required : 2 bolts M6x16 V4A (to be ordered separately)

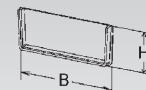

GRP adjustable splice plate

pressed, horizontal

Item ref.	RAL colour	Height	EAN code	Weight 100 units	Min. pack.
		mm			
K23 KKGH 110	7032	89	955640	2	1 set

for the horizontal connection of cable trays and fittings H110 mm lengthwise

Need: 2 pieces for each cut

for the cable tray connection with an expansion joint

Mounting accessories required : 4 bolts M6x20 V4A (to be ordered separately)

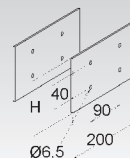

Horizontal splice plate

horizontal

Item ref.	Height mm	RAL colour	EAN code	Weight 100 units pc/m	Min. pack.
E4 KKIH 110 E4	80	7032	955671	16,6	1 set

Need: 2 pieces for each cut

for the length adjustment, please leave a space between cable trays.

Mounting accessories required : 4 bolts M6x16 V4A (to be ordered separately)

110

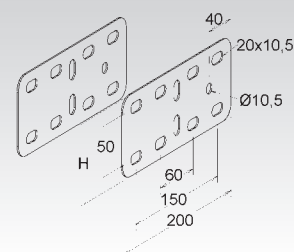

GRP separator

pressed

Item ref.	RAL colour	Height mm	EAN code	Weight 100 units pc/m	Min. pack.
K23 KKT 110	7032	102	953042	40	3 m
K23 KKT 110/M	7032	102	953073	40	3 m

to separate cables with different functions and / or to separate voltages

The divider KKT 110 is delivered not mounted, it can be fixed in the cable tray with a bolt M 6x16 V4A each meter.

The divider KKT110/M can be delivered pre-mounted (riveted), the position inside the cable tray must be defined in the purchase order.

110

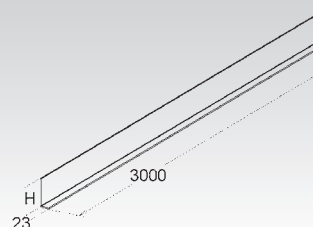

GRP tee junction for cable tray, large radius

pressed, with interlocking coupler

Item ref.	RAL colour	Height mm	Width B mm	EAN code	Weight 100 units pc	Min. pack.
K23 KKST 110.100	7032	110	100	954698	78,0	1 p.
K23 KKST 110.200	7032	110	200	954704	120,0	1 p.
K23 KKST 110.300	7032	110	300	954711	128,5	1 p.
K23 KKST 110.400	7032	110	400	954728	200,0	1 p.
K23 KKST 110.500	7032	110	500	954735	170,0	1 p.
K23 KKST 110.600	7032	110	600	954742	190,0	1 p.

During assembly, all the fittings must be supported at every cables entry, add a centrale support for all fittings with radius greater than 250 mm, and/or with width greater than 400 mm

To ensure a correct installation, the couplers must be fixed laterally by 4 bolts M6x16 V4A on each tray end.

110

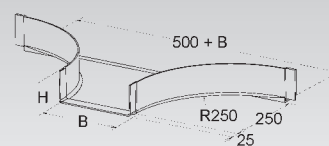

Horizontal elbow 45°

pressed, with interlocking coupler

Item ref.	RAL colour	Height mm	Width B mm	Radius R mm	EAN code	Weight 100 units pc	Min. pack.
K23 KKC 110.100	7032	110	100	200	953523	22,0	1 p.
K23 KKC 110.200	7032	110	200	200	953530	65,0	1 p.
K23 KKC 110.300	7032	110	300	225	953547	108,5	1 p.
K23 KKC 110.400	7032	110	400	250	953554	197,0	1 p.
K23 KKC 110.500	7032	110	500	250	953561	313,0	1 p.
K23 KKC 110.600	7032	110	600	250	953578	342,0	1 p.

The piece is provided with a sleeve riveted on one side only.

During assembly, all the fittings must be supported at every cables entry, add a centrale support for all fittings with radius greater than 250 mm, and/or with width greater than 400 mm

110

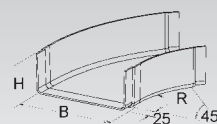

Horizontal elbow 90°, small radius

pressed, with interlocking coupler

Item ref.	RAL colour	Height mm	Width B mm	EAN code	Weight 100 units pc/m	Min. pack.
K23 KKW 110.100	7032	110	100	953776	40	1 p.
K23 KKW 110.200	7032	110	200	953783	70	1 p.
K23 KKW 110.300	7032	110	300	953790	86	1 p.
K23 KKW 110.400	7032	110	400	953806	125	1 p.
K23 KKW 110.500	7032	110	500	953813	195	1 p.
K23 KKW 110.600	7032	110	600	953820	240	1 p.

During assembly, all the fittings must be supported at every cables entry, add a centrale support for all fittings with radius greater than 250 mm, and/or with width greater than 400 mm

110

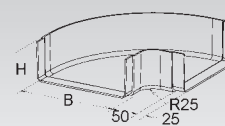

CABLE TRAY SYSTEM K²

Horizontal elbow 90°, large radius

pressed, with interlocking coupler

Item ref.	RAL colour	Height	Width B	C	Radius R	EAN code	Weight 100 units pc	Min. pack.
		mm	mm	mm	mm			
K23 KKB 110.100	7032	110	100	125	100	953288	98,0	1 p.
K23 KKB 110.200	7032	110	200	225	200	953295	132,5	1 p.
K23 KKB 110.300	7032	110	300	250	225	953301	217,0	1 p.
K23 KKB 110.400	7032	110	400	325	250	953318	360,0	1 p.
K23 KKB 110.500	7032	110	500	325	250	953325	490,0	1 p.
K23 KKB 110.600	7032	110	600	325	250	953332	434,0	1 p.

During assembly, all the fittings must be supported at every cables entry, add a centrale support for all fittings with radius greater than 250 mm, and/or with width greater than 400 mm
To ensure a correct installation, the couplers must be fixed laterally by 2 bolts M6x16 V4A on each tray end.

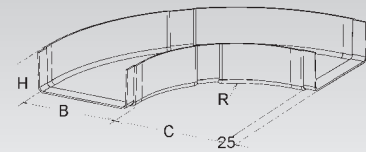

GRP right hand reduction

pressed, with interlocking coupler

Item ref.	RAL colour	Height	Width B	EAN code	Weight 100 units pc	Min. pack.
		mm	mm			
K23 KKRR 110.200	7032	110	200	962549	100	1 p.
K23 KKRR 110.300	7032	110	300	955091	124	1 p.
K23 KKRR 110.400	7032	110	400	955107	160	1 p.
K23 KKRR 110.500	7032	110	500	955114	180	1 p.
K23 KKRR 110.600	7032	110	600	955121	240	1 p.

During the assembly, every fitting must be supported at each end, at the cable entry.
To ensure a correct installation, the couplers must be fixed laterally by 2 bolts M6x16 V4A on each tray end.

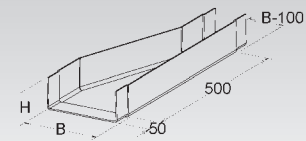

GRP left hand reduction

pressed, with interlocking coupler

Item ref.	RAL colour	Height	Width B	Covers length	EAN code	Weight 100 units pc/m	Min. pack.
		mm	mm	mm			
K23 KKRL 110.200	7032	110	200	500	962532	100	1 p.
K23 KKRL 110.300	7032	110	300	500	954988	124	1 p.
K23 KKRL 110.400	7032	110	400	500	954995	200	1 p.
K23 KKRL 110.500	7032	110	500	500	955008	195	1 p.
K23 KKRL 110.600	7032	110	600	500	955015	220	1 p.

During the assembly, we recommend to support each end of fitting at each cable entry.
To ensure a correct installation, the couplers must be fixed laterally by 2 bolts M6x16 V4A on each tray end.

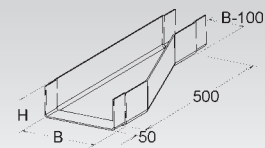

GRP vertical splice plate

pressed, vertical

Item ref.	RAL colour	Height	EAN code	Weight 100 units	Min. pack.
		mm			
K23 KKGV 110	7032	90	955152	19	1 set

for the vertical connection of cable trays and fittings H110 with an angle adjustment.

Need: 2 pieces for each cut

Mounting accessories required : 4 bolts M6x20 V4A (to be ordered separately)

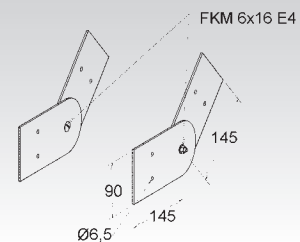

Stainless steel vertical splice plate V4A

vertical, stainless steel

Item ref.	Height	EAN code	Weight 100 units	Min. pack.
	mm			
E4 KKIV 110 E4	80	955183	36	1 set

for the horizontal connection of cable trays and fittings H110 mm and for the changes of directions.

Need: 2 pieces for each cut

Mounting accessories required : 4 bolts M6x16 V4A (to be ordered separately)

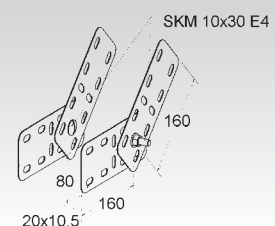

GRP changing elevation

pressed, with interlocking coupler

Item ref.	RAL colour	Height	Width B	Height H1	Height H2	Height H3	EAN code	Weight 100 units pc	Min. pack.
		mm	mm	mm	mm	mm			
K23 KKET 110.100	7032	110	100	160	480	800	954452	190	1 p.
K23 KKET 110.200	7032	110	200	160	480	800	954469	210	1 p.
K23 KKET 110.300	7032	110	300	160	480	800	954476	344	1 p.
K23 KKET 110.400	7032	110	400	160	480	800	954483	420	1 p.
K23 KKET 110.500	7032	110	500	160	480	800	954490	480	1 p.
K23 KKET 110.600	7032	110	600	160	480	800	954506	596	1 p.

Composed with different pieces, the changing elevation can be mounted in different heights

During assembly, all the fittings must be supported at every cables entry, add a centrale support for all fittings with radius greater than 250 mm, and/or with width greater than 400 mm

To ensure a correct installation, the couplers must be fixed laterally by 2 bolts M6x16 V4A on each tray end.

The part height depends on the height and the configuration used

H1 = 160 mm => L1 = 785 mm (a cut is necessary)

H2 = 480 mm => L2 = 1100 mm

H3 = 800 mm => L3 = 970 mm

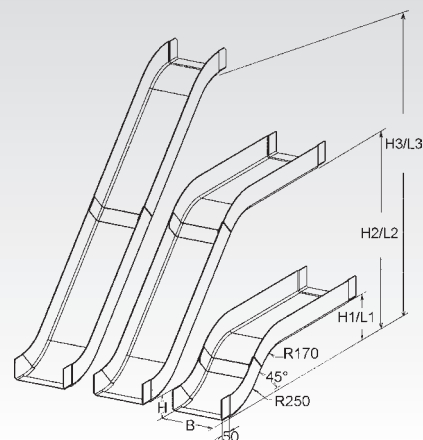
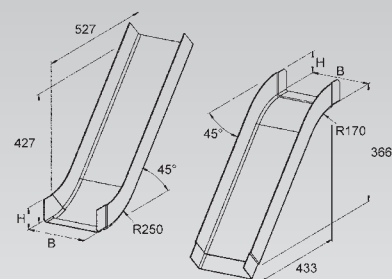

GRP vertical inside elbow

pressed, with interlocking coupler

Item ref.	RAL colour	Height	Width B	EAN code	Weight 100 units pc	Min. pack.
		mm	mm			
K23 KKBI 110.100	7032	110	100	954155	53	1 p.
K23 KKBI 110.200	7032	110	200	954162	100	1 p.
K23 KKBI 110.300	7032	110	300	954179	123	1 p.
K23 KKBI 110.400	7032	110	400	954186	143	1 p.
K23 KKBI 110.500	7032	110	500	954193	175	1 p.
K23 KKBI 110.600	7032	110	600	954209	170	1 p.

During assembly, all the fittings must be supported at every cables entry, add a centrale support for all fittings with radius greater than 250 mm, and/or with width greater than 400 mm

To ensure a correct installation, the couplers must be fixed laterally by 2 bolts M6x16 V4A on each tray end.

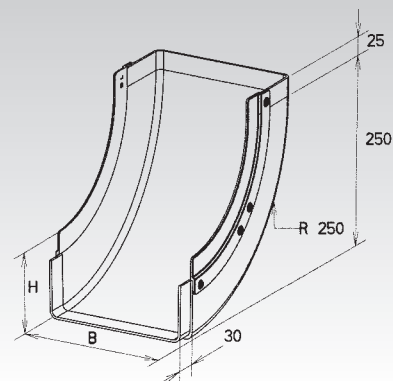

GRP vertical outside elbow

pressed, with interlocking coupler

Item ref.	RAL colour	Height	Width B	EAN code	Weight 100 units pc	Min. pack.
		mm	mm			
K23 KKBA 110.100	7032	110	100	953967	46	1 p.
K23 KKBA 110.200	7032	110	200	953974	82	1 p.
K23 KKBA 110.300	7032	110	300	953981	110	1 p.
K23 KKBA 110.400	7032	110	400	953998	130	1 p.
K23 KKBA 110.500	7032	110	500	954001	205	1 p.
K23 KKBA 110.600	7032	110	600	954018	138	1 p.

During assembly, all the fittings must be supported at every cables entry, add a centrale support for all fittings with radius greater than 250 mm, and/or with width greater than 400 mm

To ensure a correct installation, the couplers must be fixed laterally by 2 bolts M6x16 V4A on each tray end.

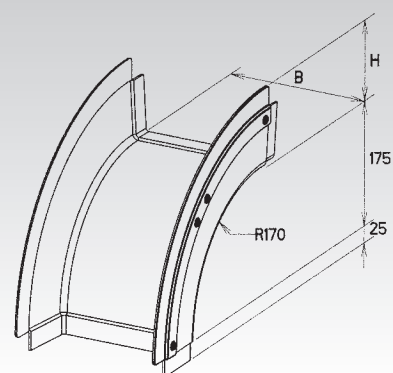

CABLE TRAY SYSTEM K²

Mounting plate

pressed, easy to install, with pre-mounted fixing clamps

Item ref.	RAL colour	Height mm	EAN code	Weight 100 units pc	Min. pack.
E4 K23 MP 110	7032	110	963034	17	1 p.

for the installation of equipment or junction boxes

The mounting plate is in GRP, only the mounting lug are in stainless steel V4A

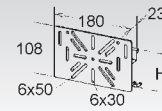

NOTES

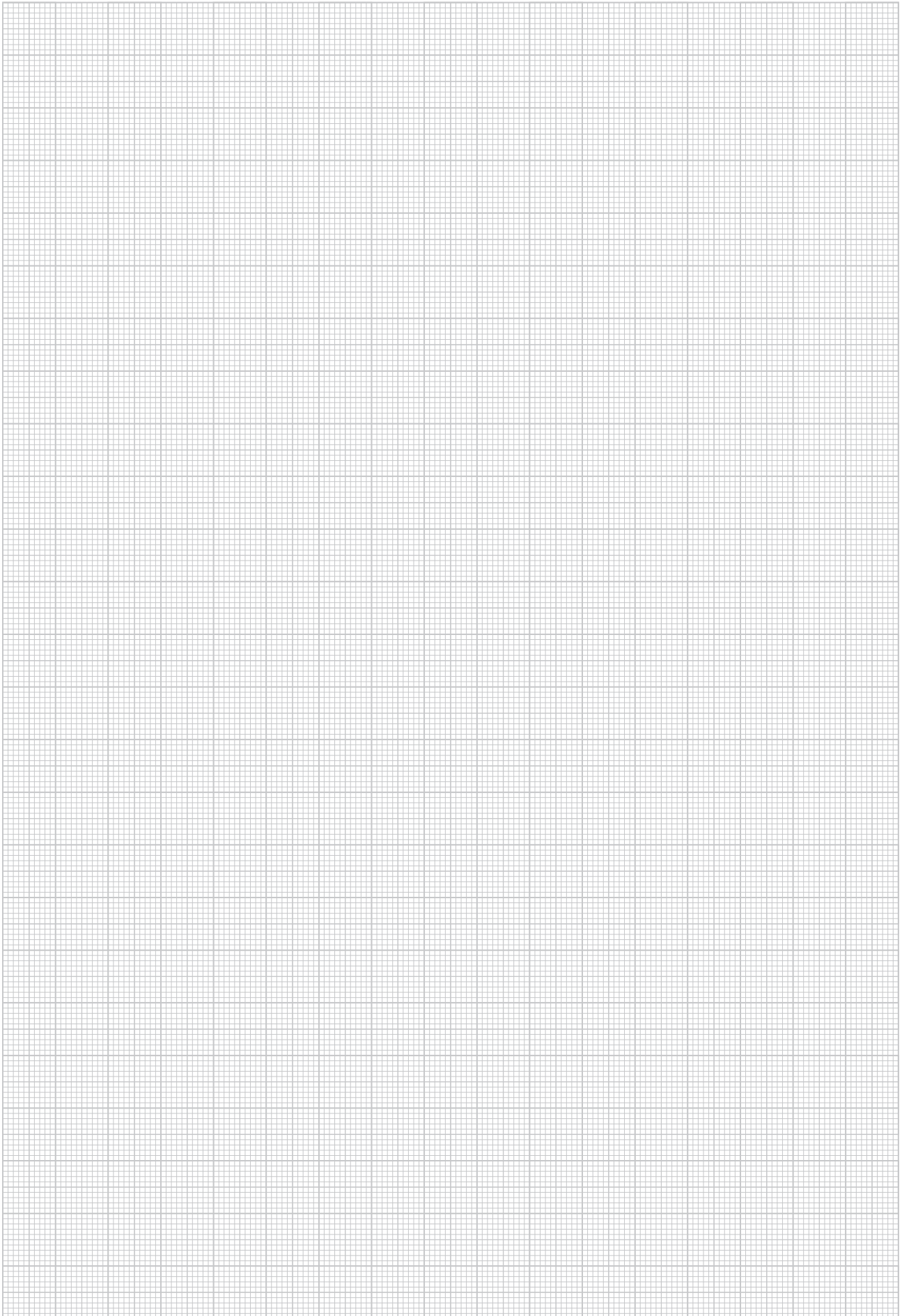

CABLE TRAY SYSTEM COVERS K²

Cover for cable trays and cable ladders

pressed

Item ref.	RAL colour	Width B mm	EAN code	Weight 100 units pc	Min. pack.
K23 KKD 100	7032	100	956111	78	3 m
K23 KKD 150	7032	150	956128	105	3 m
K23 KKD 200	7032	200	956135	132	3 m
K23 KKD 250	7032	250	956142	152	3 m
K23 KKD 300	7032	300	956159	190	3 m
K23 KKD 400	7032	400	956166	243	3 m
K23 KKD 500	7032	500	956180	292	3 m
K23 KKD 600	7032	600	956197	338	3 m

For a stronger assembly, the covers with a width above 400 mm are strengthened. These strengthenings / ribs are visible on the outside face of the part.

Used for: Cable tray H50, H80 and H110 mm, KK..., KKL... and cable ladder UL...H53, H80, H100 and H150 mm

For a strong and compliant assembly, we recommend to leave a minimum distance of 8 mm between the covers and the sidewalls of cable trays.

Covers are attached by using stainless steel cover clips DF...V4A, DF M... and DFUB... In extreme weather conditions, strong winds, storms for example, the quantity of clips must be increased.

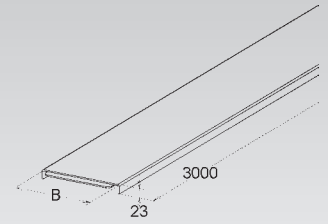

GRP cover for horizontal elbow 45°, small radius

pressed

Item ref.	RAL colour	Width B mm	EAN code	Weight 100 units pc	Min. pack.
K23 KKCD 100	7032	100	956456	12	1 p.
K23 KKCD 150	7032	150	956463	23	1 p.
K23 KKCD 200	7032	200	956470	33	1 p.
K23 KKCD 250	7032	250	956487	50	1 p.
K23 KKCD 300	7032	300	956494	51	1 p.
K23 KKCD 400	7032	400	956500	138	1 p.
K23 KKCD 500	7032	500	956517	150	1 p.
K23 KKCD 600	7032	600	956524	173	1 p.

Used for: Elbow 45° H50, H80 and H110 mm, KKC... and KPC.../P

Covers are attached by using stainless steel cover clips DF...V4A, DF M... and DFUB... In extreme weather conditions, strong winds, storms for example, the quantity of clips must be increased.

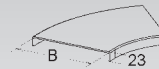

Cover for horizontal elbow 90°, large radius

pressed

Item ref.	RAL colour	Width B mm	EAN code	Weight 100 units pc	Min. pack.
K23 KKBD 100	7032	100	956371	19,5	1 p.
K23 KKBD 150	7032	150	956388	43,0	1 p.
K23 KKBD 200	7032	200	956395	68,0	1 p.
K23 KKBD 250	7032	250	956401	97,0	1 p.
K23 KKBD 300	7032	300	956418	115,0	1 p.
K23 KKBD 400	7032	400	956425	241,0	1 p.
K23 KKBD 500	7032	500	956432	334,0	1 p.
K23 KKBD 600	7032	600	956449	403,0	1 p.

Used for: Horizontal elbow 90°, large radius, H50, H80 and H110, KKB... and KPB.../P

Covers are attached by using stainless steel cover clips DF...V4A, DF M... and DFUB... In extreme weather conditions, strong winds, storms for example, the quantity of clips must be increased.

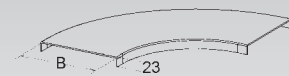

Cover for horizontal elbow 90°, small radius

pressed

Item ref.	RAL colour	Width B mm	EAN code	Weight 100 units pc	Min. pack.
K23 KKWD 50	7032	50	956531	6,0	1 p.
K23 KKWD 100	7032	100	956548	11,5	1 p.
K23 KKWD 150	7032	150	956555	21,0	1 p.
K23 KKWD 200	7032	200	956562	31,0	1 p.
K23 KKWD 250	7032	250	956579	41,5	1 p.
K23 KKWD 300	7032	300	956586	60,0	1 p.
K23 KKWD 400	7032	400	956593	93,0	1 p.
K23 KKWD 500	7032	500	956609	125,0	1 p.
K23 KKWD 600	7032	600	956616	187,0	1 p.

Used for: Horizontal elbow 90°, H50, H80 and H110, KKW...

Covers are attached by using stainless steel cover clips DF...V4A, DF M... and DFUB... In extreme weather conditions, strong winds, storms for example, the quantity of clips must be increased.

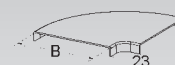

GRP cover for vertical inside elbow

pressed

Item ref.	RAL colour	Height mm	Width B mm	EAN code	Weight 100 units pc	Min. pack.
K23 KKBID 50.050	7032	50	50	956814	5	1 p.
K23 KKBID 50.100	7032	50	100	956821	20	1 p.
K23 KKBID 50.150	7032	50	150	956838	42	1 p.
K23 KKBID 50.200	7032	50	200	956845	50	1 p.
K23 KKBID 50.300	7032	50	300	956852	63	1 p.

Used for: Vertical inside elbow 50 mm high, KKBID... and KPBI.../P

Covers are attached by using stainless steel cover clips DF...V4A, DF M... and DFUB... In extreme weather conditions, strong winds, storms for example, the quantity of clips must be increased.

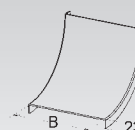

GRP cover for vertical inside elbow

pressed

Item ref.	RAL colour	Height mm	Width B mm	EAN code	Weight 100 units pc	Min. pack.
K23 KKBID 80.100	7032	80	100	956869	18,0	1 p.
K23 KKBID 80.150	7032	80	150	956876	24,5	1 p.
K23 KKBID 80.200	7032	80	200	956883	33,0	1 p.
K23 KKBID 80.250	7032	80	250	956890	40,0	1 p.
K23 KKBID 80.300	7032	80	300	956906	45,5	1 p.
K23 KKBID 80.400	7032	80	400	956913	61,0	1 p.
K23 KKBID 80.500	7032	80	500	956920	73,0	1 p.
K23 KKBID 80.600	7032	80	600	956937	95,0	1 p.

Used for: Vertical inside elbow 80 mm high, KKBID... and KPBI.../P

Covers are attached by using stainless steel cover clips DF...V4A, DF M... and DFUB... In extreme weather conditions, strong winds, storms for example, the quantity of clips must be increased.

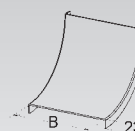

GRP cover for vertical inside elbow

pressed

Item ref.	RAL colour	Height mm	Width B mm	EAN code	Weight 100 units pc	Min. pack.
K23 KKBID 110.100	7032	110	100	956944	18	1 p.
K23 KKBID 110.200	7032	110	200	956951	30	1 p.
K23 KKBID 110.300	7032	110	300	956968	50	1 p.
K23 KKBID 110.400	7032	110	400	956975	100	1 p.
K23 KKBID 110.500	7032	110	500	956982	120	1 p.
K23 KKBID 110.600	7032	110	600	956999	130	1 p.

Used for: Vertical inside elbow 110 mm high, KKBID... and KPBI.../P

Covers are attached by using stainless steel cover clips DF...V4A, DF M... and DFUB... In extreme weather conditions, strong winds, storms for example, the quantity of clips must be increased.

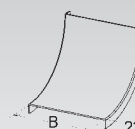

CABLE TRAY SYSTEM COVERS K²

GRP cover for vertical outside elbow

pressed

Item ref.	RAL colour	Height mm	Width B mm	EAN code	Weight 100 units pc	Min. pack.
K23 KKBAD 50.050	7032	50	50	956623	7,8	1 p.
K23 KKBAD 50.100	7032	50	100	956630	10,0	1 p.
K23 KKBAD 50.150	7032	50	150	956647	42,0	1 p.
K23 KKBAD 50.200	7032	50	200	956654	51,0	1 p.
K23 KKBAD 50.300	7032	50	300	956661	65,0	1 p.

Used for: Vertical outside elbow H50 mm, KKBA... and KPBA.../P

Covers are attached by using stainless steel cover clips DF...V4A, DF M... and DFUB... In extreme weather conditions, strong winds, storms for example, the quantity of clips must be increased.

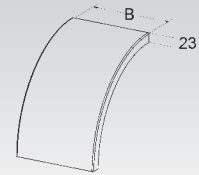

GRP cover for vertical outside elbow

pressed

Item ref.	RAL colour	Height mm	Width B mm	EAN code	Weight 100 units pc	Min. pack.
K23 KKBAD 80.100	7032	80	100	956678	29,5	1 p.
K23 KKBAD 80.150	7032	80	150	956685	39,0	1 p.
K23 KKBAD 80.200	7032	80	200	956692	51,0	1 p.
K23 KKBAD 80.250	7032	80	250	956708	61,0	1 p.
K23 KKBAD 80.300	7032	80	300	956715	72,0	1 p.
K23 KKBAD 80.400	7032	80	400	956722	90,0	1 p.
K23 KKBAD 80.500	7032	80	500	956739	120,0	1 p.
K23 KKBAD 80.600	7032	80	600	956746	136,0	1 p.

Used for: Vertical outside elbow H80 mm, KKBA... and KPBA.../P

Covers are attached by using stainless steel cover clips DF...V4A, DF M... and DFUB... In extreme weather conditions, strong winds, storms for example, the quantity of clips must be increased.

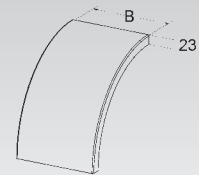

GRP cover for vertical outside elbow

pressed

Item ref.	RAL colour	Height mm	Width B mm	EAN code	Weight 100 units pc	Min. pack.
K23 KKBAD 110.100	7032	110	100	956753	35	1 p.
K23 KKBAD 110.200	7032	110	200	956760	50	1 p.
K23 KKBAD 110.300	7032	110	300	956777	70	1 p.
K23 KKBAD 110.400	7032	110	400	956784	80	1 p.
K23 KKBAD 110.500	7032	110	500	956791	120	1 p.
K23 KKBAD 110.600	7032	110	600	956807	130	1 p.

Used for: Vertical outside elbow H110 mm, KKBA... and KPBA.../P

Covers are attached by using stainless steel cover clips DF...V4A, DF M... and DFUB... In extreme weather conditions, strong winds, storms for example, the quantity of clips must be increased.

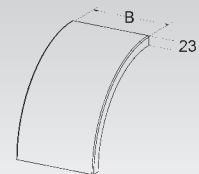

GRP cover for changing elevation

pressed

Item ref.	RAL colour	Height mm	Width B mm	EAN code	Weight 100 units pc	Min. pack.
K23 KKETD 50.100	7032	50	100	957002	20	1 p.
K23 KKETD 50.150	7032	50	150	957019	41	1 p.
K23 KKETD 50.200	7032	50	200	957026	40	1 p.
K23 KKETD 50.300	7032	50	300	957033	60	1 p.

1 KKETD is composed of :

- 1 GRP cover for inside elbow
- 1 GRP cover for outside elbow

Used for: Changing elevation H50 mm KKET... and KPET.../P

Covers are attached by using stainless steel cover clips DF...V4A, DF M... and DFUB... In extreme weather conditions, strong winds, storms for example, the quantity of clips must be increased.

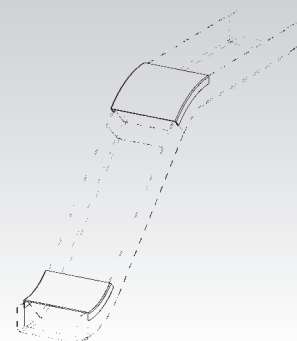

GRP cover for changing elevation

pressed

Item ref.	RAL colour	Height mm	Width B mm	EAN code	Weight 100 units pc	Min. pack.
K23 KKETD 80.100	7032	80	100	957040	23,5	1 p.
K23 KKETD 80.150	7032	80	150	957057	31,7	1 p.
K23 KKETD 80.200	7032	80	200	957064	40,5	1 p.
K23 KKETD 80.250	7032	80	250	957071	44,0	1 p.
K23 KKETD 80.300	7032	80	300	957088	47,0	1 p.
K23 KKETD 80.400	7032	80	400	957095	61,0	1 p.
K23 KKETD 80.500	7032	80	500	957101	98,0	1 p.
K23 KKETD 80.600	7032	80	600	957118	120,0	1 p.

- 1 KKETD is composed of :
- 1 GRP cover for inside elbow
 - 1 GRP cover for outside elbow

Used for: Changing elevation H50 mm KKET... and KPET.../P

Covers are attached by using stainless steel cover clips DF...V4A, DF M... and DFUB... In extreme weather conditions, strong winds, storms for example, the quantity of clips must be increased.

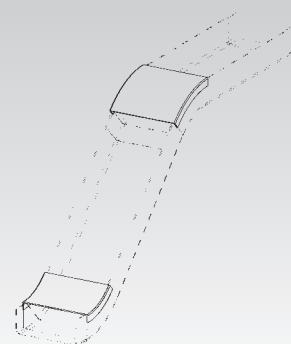

GRP cover for changing elevation

pressed

Item ref.	RAL colour	Height mm	Width B mm	EAN code	Weight 100 units pc	Min. pack.
K23 KKETD 110.100	7032	110	100	957125	23,5	1 p.
K23 KKETD 110.200	7032	110	200	957132	40,0	1 p.
K23 KKETD 110.300	7032	110	300	957149	47,0	1 p.
K23 KKETD 110.400	7032	110	400	957156	61,0	1 p.
K23 KKETD 110.500	7032	110	500	957163	98,0	1 p.
K23 KKETD 110.600	7032	110	600	957170	120,0	1 p.

- 1 KKETD is composed of :
- 1 GRP cover for inside elbow
 - 1 GRP cover for outside elbow

Used for: Changing elevation H110 mm KKET...

Covers are attached by using stainless steel cover clips DF...V4A, DF M... and DFUB... In extreme weather conditions, strong winds, storms for example, the quantity of clips must be increased.

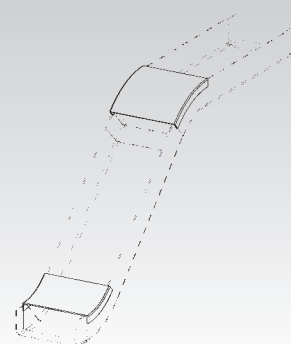

GRP cover for tee junction, large radius

pressed, with interlocking coupler

Item ref.	RAL colour	Width B mm	EAN code	Weight 100 units pc	Min. pack.
K23 KKSTD 100	7032	100	957187	35	1 p.
K23 KKSTD 150	7032	150	957194	42	1 p.
K23 KKSTD 200	7032	200	957200	52	1 p.
K23 KKSTD 250	7032	250	957217	63	1 p.
K23 KKSTD 300	7032	300	957224	65	1 p.
K23 KKSTD 400	7032	400	957231	78	1 p.
K23 KKSTD 500	7032	500	957248	100	1 p.
K23 KKSTD 600	7032	600	957255	118	1 p.

Used for: Cover for tee junction for H50, H80 and H110 mm, KKST... and KPST.../P

Covers are attached by using stainless steel cover clips DF...V4A, DF M... and DFUB... In extreme weather conditions, strong winds, storms for example, the quantity of clips must be increased.

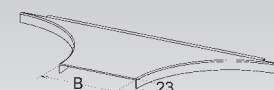

Tee junction cover, small radius

pressed, with interlocking coupler

Item ref.	RAL colour	Width B mm	EAN code	Weight 100 units pc	Min. pack.
K23 KKSSD 50	7032	50	957262	5,0	1 p.
K23 KKSSD 100	7032	100	957279	8,0	1 p.
K23 KKSSD 150	7032	150	957286	9,5	1 p.
K23 KKSSD 200	7032	200	957293	13,0	1 p.
K23 KKSSD 250	7032	250	957309	14,5	1 p.
K23 KKSSD 300	7032	300	957316	15,5	1 p.

Used for: Tee junction for H50 and H80 mm, KKSS... and KPSS.../P

Covers are attached by using stainless steel cover clips DF...V4A, DF M... and DFUB... In extreme weather conditions, strong winds, storms for example, the quantity of clips must be increased.

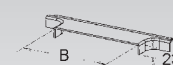

CABLE TRAY SYSTEM COVERS K²

GRP cover for right hand reduction

pressed

Item ref.	RAL colour	Width B mm	EAN code	Weight 100 units pc	Min. pack.
K23 KKRRD 200	7032	200	957378	50,5	1 p.
K23 KKRRD 300	7032	300	957385	79,0	1 p.
K23 KKRRD 400	7032	400	957392	119,0	1 p.
K23 KKRRD 500	7032	500	957408	131,0	1 p.
K23 KKRRD 600	7032	600	957415	160,0	1 p.

Used for: Right hand reduction H50, H80 and H110 mm, KKRR...

Covers are attached by using stainless steel cover clips DF...V4A, DF M... and DFUB... In extreme weather conditions, strong winds, storms for example, the quantity of clips must be increased.

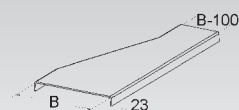

GRP cover for left hand reduction

pressed

Item ref.	RAL colour	Width B mm	EAN code	Weight 100 units pc	Min. pack.
K23 KKRLD 200	7032	200	957323	49	1 p.
K23 KKRLD 300	7032	300	957330	75	1 p.
K23 KKRLD 400	7032	400	957347	110	1 p.
K23 KKRLD 500	7032	500	957354	147	1 p.
K23 KKRLD 600	7032	600	957361	160	1 p.

Used for: Reduction H50, 80 and 110 mm, KKRL...

Covers are attached by using stainless steel cover clips DF...V4A, DF M... and DFUB... In extreme weather conditions, strong winds, storms for example, the quantity of clips must be increased.

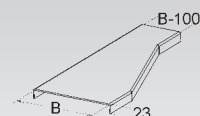

Cover fixing clip

stainless steel

Item ref.	Height mm	EAN code	Weight 100 units pc.	Min. pack.
E4 DF 50 E4	55	957873	1,7	50 p.
E4 DF 80 E4	85	957880	2,1	50 p.
E4 DF 100 E4	110	957897	2,3	50 p.

for fixing the cables tray covers and fittings

Used for: Cable tray cover KKD... and KPD...

Cover for fittings KKCD..., KKBD..., KKWD..., KKBAD..., KKBID..., KKETD..., KKSTD..., KKSSD..., KKRLD... and KKRRD...

Under normal conditions, it is recommended to mount 1 clip each meter alternatively every 3 meters. Under extreme weather conditions, such as strong winds or storms, the quantity of clips must be increased.



Cover fixing

Item ref.	EAN code	Weight 100 units pc.	Min. pack.
K01 DF M	957927	0,2	50 p.

Used for: Cover for cable tray KKD... and KPD...

Cover for fittings KKCD..., KKBD..., KKWD..., KKBAD..., KKBID..., KKETD..., KKSTD..., KKSSD..., KKRLD... und KKRRD...

For fixing the cover, it is necessary to drill a 8,2 mm diameter hole for the diameter. In extreme weather conditions such as strong winds, for example, the quantity of clips must be increased.

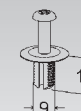

Cover fixing

Item ref.	EAN code	Weight 100 units pc.	Min. pack.
★ E4 DFUB 5.5X19 E4	062065	0,64	50 p.

Used for: Cover for cable tray KKD... and KPD...

Cover for fittings KKCD..., KKBD..., KKWD..., KKBAD..., KKBID..., KKETD..., KKSTD..., KKSSD..., KKRLD... und KKRRD...

For fixing the cover, it is necessary to drill a 8,2 mm diameter hole for the diameter. In extreme weather conditions such as strong winds, for example, the quantity of clips must be increased.

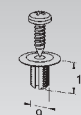

Cover fixing clip

stainless steel

Item ref.	EAN code	Weight 100 units pc.	Min. pack.
E4 DF 1060 E4	957910	1,1	50 p.

for fixing the cables tray covers and fittings

Used for: Cable tray cover KKD...

Under normal conditions, it is recommended to mount 1 clip each meter alternatively every 3 meters. Under extreme weather conditions, such as strong winds or storms, the quantity of clips must be increased.

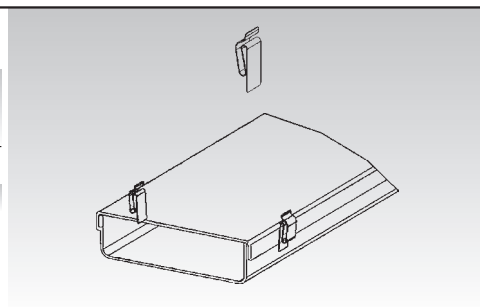

CABLE TRAY SYSTEM ACCESSOIRES K²

Separating stud

pultruded

Item ref.	EAN code	Weight 100 units m	Min. pack.
K01 TB	957934	1	1 p.

for an easy mounting of cables and connections

Not suitable when the cable tray is mounted vertically (not horizontally)

When mounting the separating stud, it is necessary to drill a 10 mm hole diameter in the base.

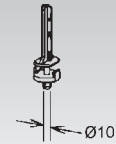

Dome head bolt

Included nut and washer

Item ref.	Thread M	Length L mm	EAN code	Weight 100 units pc	Min. pack.
E4 FKM 6X16 E4	6	16	962693	1,2	100 p.
E4 FKM 6X20 E4	6	20	962709	1,4	100 p.

Also named M6x16V4A for FKM 6x16 E4, M6x20V4A for FKM 6x20 E4, M8x20PA6 for FKM 8x20 K01, M10x30V4A for SKM 10x30 E4



Dome head bolt

Included nut and washer

Item ref.	Thread M	Length L mm	EAN code	Weight 100 units pc	Min. pack.
K01 FKM 8X20 K01	8	20	962716	0,4	100 p.

Also named M6x16V4A for FKM 6x16 E4, M6x20V4A for FKM 6x20 E4, M8x20PA6 for FKM 8x20 K01, M10x30V4A for SKM 10x30 E4



Hexagon head bolt

Included nut and washer

Item ref.	Thread M	Length L mm	EAN code	Weight 100 units pc	Min. pack.
E4 SKM 10X30 E4	10	30	962730	4,5	100 p.
E4 SKM 10X40 E4	10	40	962747	5,1	100 p.

Also named M6x16V4A for FKM 6x16 E4, M6x20V4A for FKM 6x20 E4, M8x20PA6 for FKM 8x20 K01, M10x30V4A for SKM 10x30 E4



NOTES

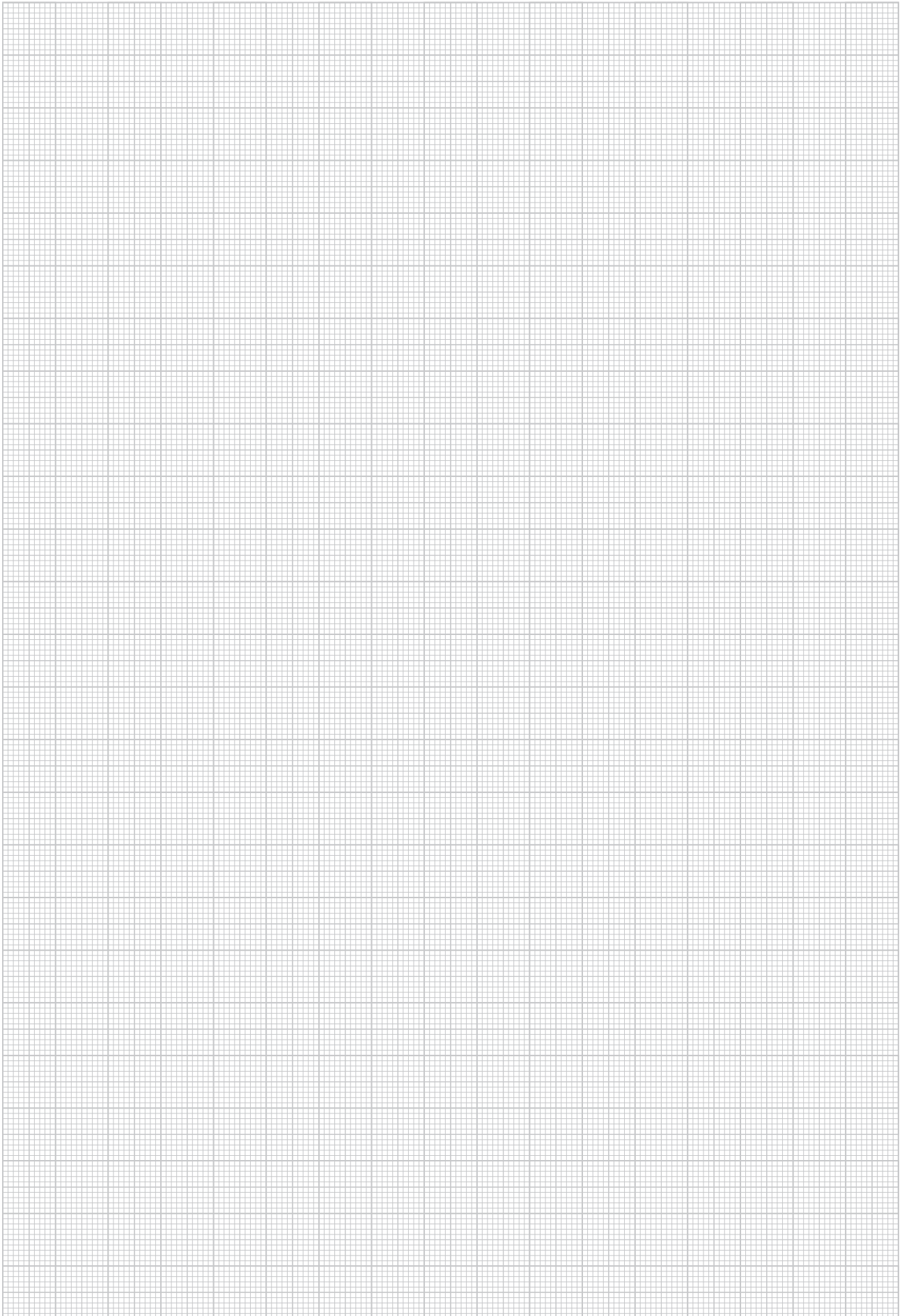

System
KP

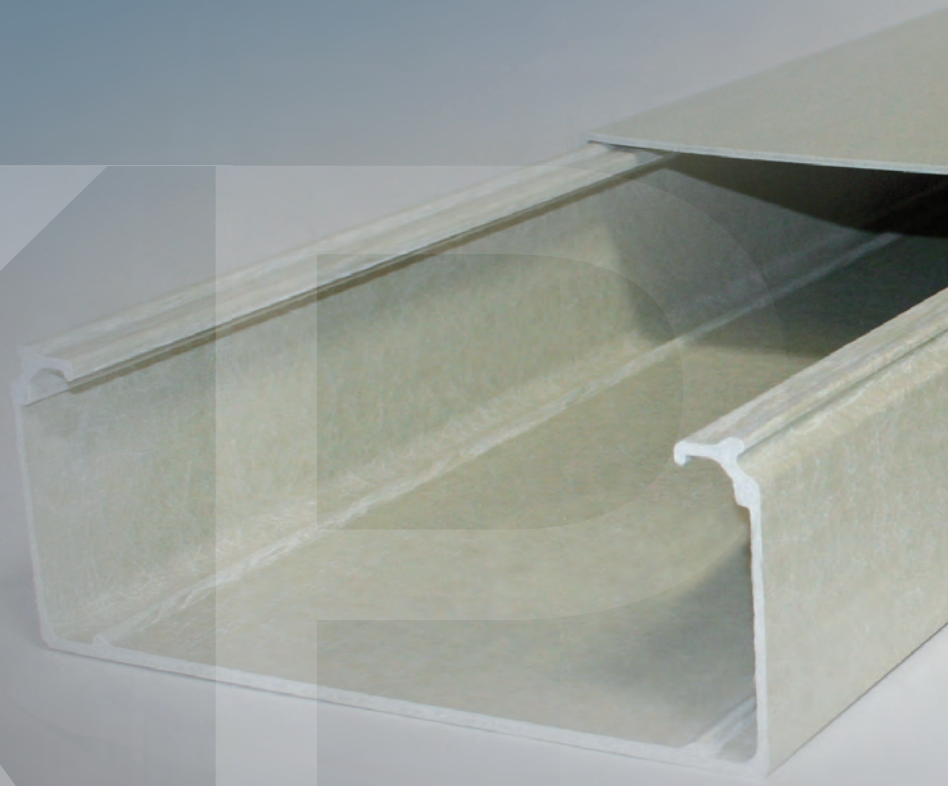

Cable tray systems available in height   

Cable trays

Covers

Dividers

Accessoires

Fittings

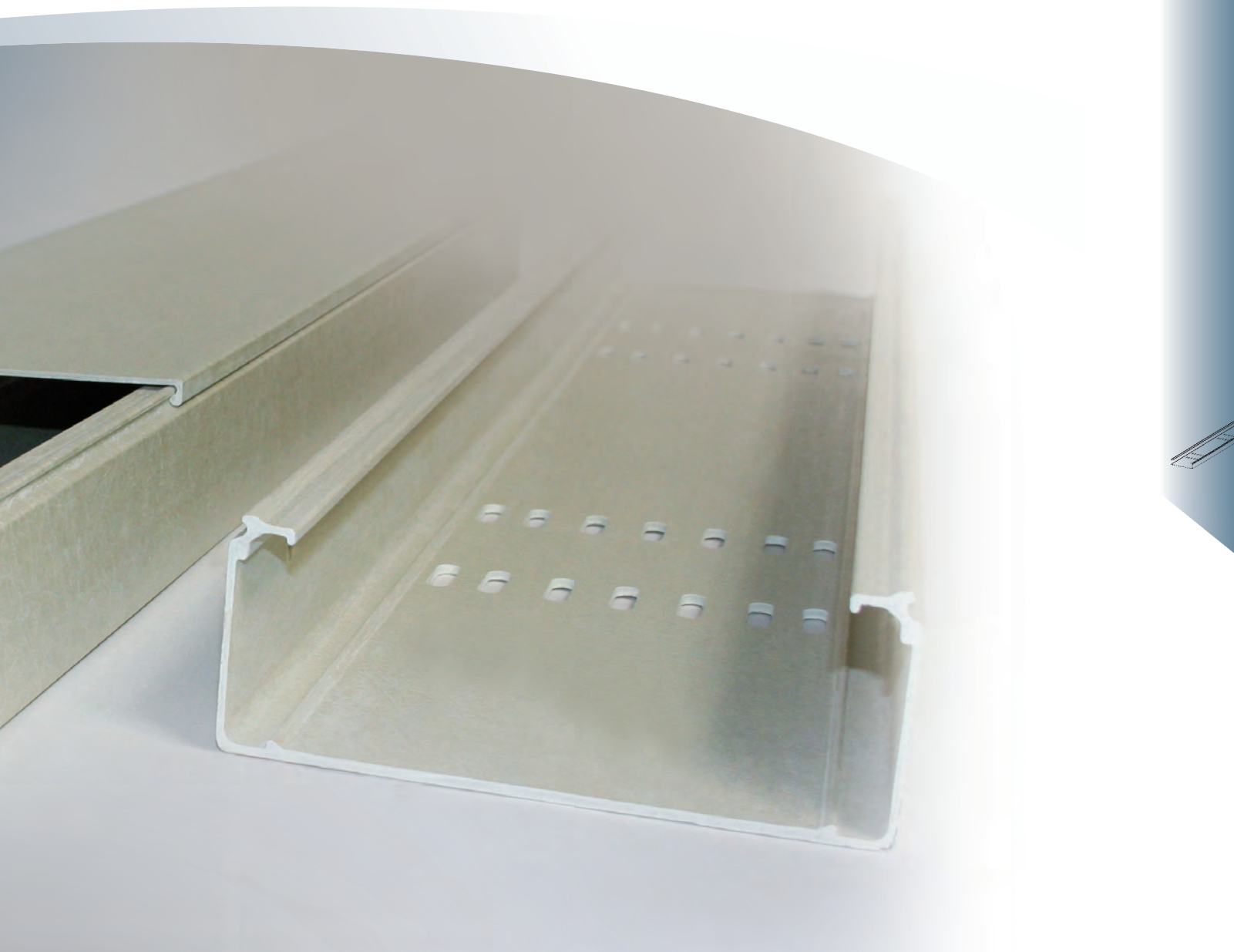





















The cable tray system KP EBO Systems (manufactured by pultrusion) provides maximum flexibility and efficiency and a support distance of up to 4 m.

Its quickly assembly with clip in jointing pieces without screws included automatically an expansion joint, greatly facilitates its installation.

CABLE TRAY SYSTEM KP

Available siderail heights

SYSTEM	GRP-Cable tray, pultruded, perfored	KPL		58		58		62
	GRP-Cable tray, pultruded, no-perforated	KP		58		58		62
ACCESSORIES	GRP-Encap, pultruded	KPKE		59		59		63
	GRP-Splice plate, pultruded, horizontal	KPGH...		59		59		63
	STAINLESS STEEL-Splice plate, horizontal	KPIH		59		—		—
	GRP-Divider, pultruded	KPT...		—		59		63
	GRP-T, pultruded, small radius	KPSS		—		59		—
	GRP-T, pultruded, big radius	KPST		—		—		63
	GRP-Elbow 45°, pressed, horizontal	KPC		—		60		63
	GRP-Elbow 90°, pressed, big radius	KPB		—		60		64
	GRP-Changing elevation, pressed	KPET		—		60		64
	GRP-Exterior changing elevation, pressed	KPBI		—		60		64
	GRP-Interior changing elevation, pressed	KPBA		—		61		64
	Cover clip	DF...		69				
	Cover fixing insert	DF M		69*				
★ NEW	Cover clip	DFUB		69*				
	Rack, pressed	KR		70*				
	Separating stud	TB		70*				
	Dome head bolt	FKM		70*				
	Hexagon head bolt	SKM		70*				

Covers for cables ladders UL systems are available from page 66.

* suitable for all heights

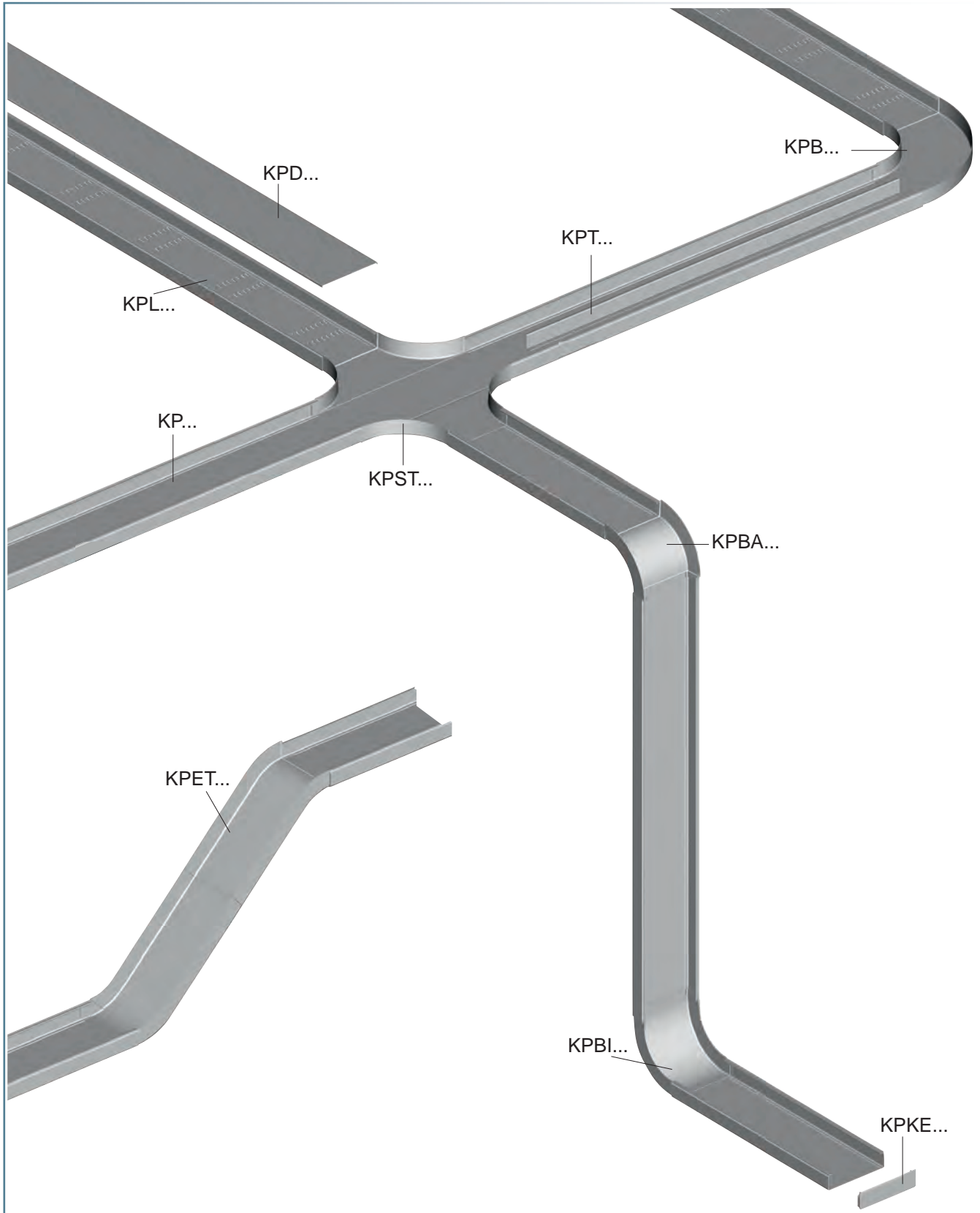

CABLE TRAY SYSTEM KP

GRP cable trays

pultruded, perforated

Item ref.	RAL colour	Height mm	Width B mm	Material thickness (th) mm	EAN code	Weight 100 units pc/m	Min. pack.
K23 KPL 40.060	7032	40	60	2,0	952557	60,0	3 m
K23 KPL 50.100	7032	50	100	2,5	952564	104,1	3 m
K23 KPL 50.150	7032	50	150	2,5	952571	130,0	3 m
K23 KPL 50.200	7032	50	200	2,5	952588	166,0	3 m
K23 KPL 40.060/6	7032	40	60	2,0	952632	60,0	6 m
K23 KPL 50.100/6	7032	50	100	2,5	952649	104,1	6 m
K23 KPL 50.150/6	7032	50	150	2,5	952656	130,0	6 m
K23 KPL 50.200/6	7032	50	200	2,5	952663	166,0	6 m

Due to the expansion of the material, the following points during installation must be observed :

The supporting systems must not be fixed close to the splice plates

For fixing the cables trays on brackets, you need to drill a 9 mm diameter hole for the fixing of the cable tray base with bolts M6x20 V4A

When fixing the splice plates KPGH... and KPIH..., an expansion distance of about 3 mm must be considered.

The splice plates KPGH 50/ KPIH 50 V4A are not included in the cables trays, please order them separately.

Load diagram : q = load evenly distributed cables (according to DIN EN IEC 61537 standard)

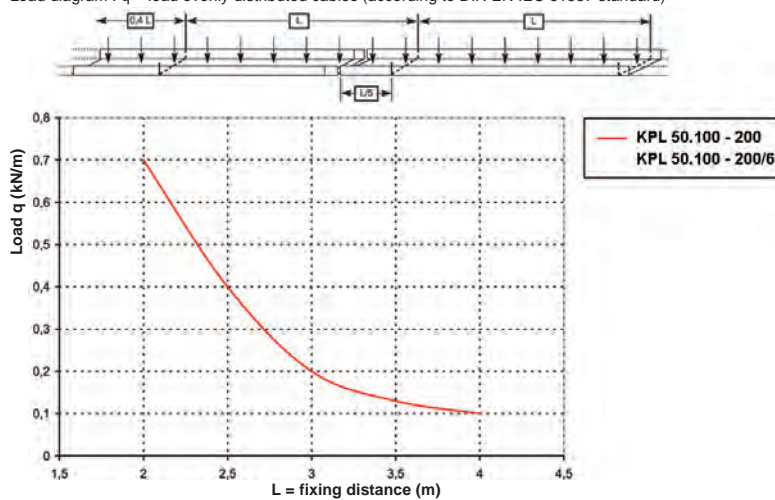

Warning : the deflection is measured with a junction position between 2 cable trays at a distance L/5 from the support. If this distance is not respected, it is necessary to raise the deflection values by approx. 30%.

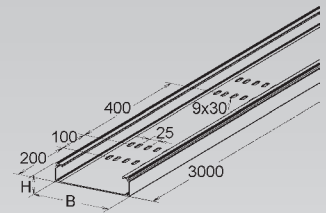

GRP cable trays

pultruded, not perforated

Item ref.	RAL colour	Height mm	Width B mm	Material thickness (th) mm	EAN code	Weight 100 units pc/m	Min. pack.
K23 KP 40.060	7032	40	60	2,0	967612	62	3 m
K23 KP 50.100	7032	50	100	2,5	952403	100	3 m
K23 KP 50.150	7032	50	150	2,5	952410	131	3 m
K23 KP 50.200	7032	50	200	2,5	952427	162	3 m
K23 KP 40.060/6	7032	40	60	2,0	952472	60	6 m
K23 KP 50.100/6	7032	50	100	2,5	952489	100	6 m
K23 KP 50.150/6	7032	50	150	2,5	952496	131	6 m
K23 KP 50.200/6	7032	50	200	2,5	952502	162	6 m

Due to the expansion of the material, the following points during installation must be observed :

The supporting systems must not be fixed close to the splice plates

For fixing the cables trays on brackets, you need to drill a 9 mm diameter hole for the fixing of the cable tray base with bolts M6x20 V4A

When fixing the splice plates KPGH... and KPIH..., an expansion distance of about 3 mm must be considered.

The splice plates KPGH 50/ KPIH 50 V4A are not included in the cables trays, please order them separately.

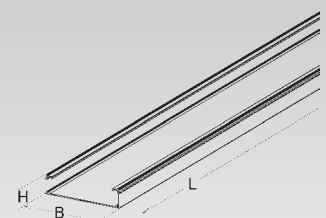

End cap for cable tray

pultruded

Item ref.	RAL colour	Height mm	Width B mm	EAN code	Weight 100 units pc	Min. pack.
K23 KPKE 40.060	7032	40	60	955381	5,5	1 p.
K23 KPKE 50.100	7032	50	100	955398	6,0	1 p.
K23 KPKE 50.150	7032	50	150	955404	9,0	1 p.
K23 KPKE 50.200	7032	50	200	955411	10,0	1 p.

for the cable tray ends

Used for: Cable tray H50, H80, KP..., KPL... and cable truncing LFG...

Mounting accessories required : 2 bolts M6x16 V4A (to be ordered separately)

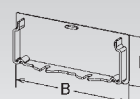

Clipsable splice plate

pressed, horizontal, fixing with bolts

Item ref.	RAL colour	Height mm	EAN code	Weight 100 units	Min. pack.
K23 KPGH 40	7032	25	955695	4,5	1 set

for the connection of cable trays and fittings H40, with splice plates H40

During the assembly, an expansion gap of 3 mm for dilatation must be considered.

Mounting accessories required : 2 bolts M6x20 V4A (to be ordered separately)

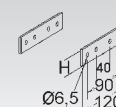

Clipsable splice plate

pultruded, horizontal

Item ref.	RAL colour	Height mm	EAN code	Weight 100 units	Min. pack.
K23 KPGH 50	7032	39	955701	6	1 set

for the connection of cable trays and fittings H50, with splice plates H50

During the assembly, an expansion gap of 3 mm is automatically taken in consideration.

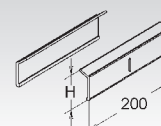

Splice plate

horizontal, stainless steel

Item ref.	Height mm	EAN code	Weight 100 units	Min. pack.
E5 KPIH 40 E5	40	955688	2,3	1 set

During the assembly, an expansion gap of 3 mm for dilatation must be considered.

Mounting accessories required : 2 bolts M6x20 V4A (to be ordered separately)

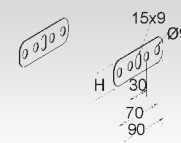

Separator

pultruded

Item ref.	RAL colour	Height mm	EAN code	Weight 100 units m	Min. pack.
K23 KPT 50	7032	37	953127	36	3 m
K23 KPT 50/M	7032	37	953141	36	3 m

to separate cables with different functions and / or to separate voltages

The divider KPT50 is delivered not mounted, it can be fixed in the cable tray with a bolt M 6x16V4A each meter.

The divider KPT50/M could be delivered pre-installed (riveted), the position inside the cable tray should be defined with the order.

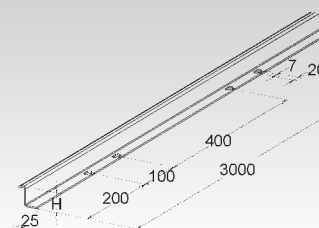

GRP tee junction, small radius

pressed, with interlocking coupler

Item ref.	RAL colour	Height mm	Width B mm	EAN code	Weight 100 units pc	Min. pack.
K23 KPSS 50.100/P	7032	50	100	954889	30	1 p.
K23 KPSS 50.150/P	7032	50	150	954896	35	1 p.
K23 KPSS 50.200/P	7032	50	200	954902	40	1 p.

During the assembly, every fitting must be supported at each end, and also in the center.

To ensure a correct installation, the couplers must be fixed laterally by 4 bolts M6x16 V4A on each tray end.

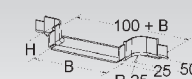

CABLE TRAY SYSTEM KP

GRP elbow 45°, small radius

pressed, with interlocking coupler

Item ref.	RAL colour	Height	Width B	Radius R	EAN code	Weight 100 units pc	Min. pack.
		mm	mm	mm			
K23 KPC 50.100/P	7032	50	100	100	953585	15	1 p.
K23 KPC 50.150/P	7032	50	150	175	953592	30	1 p.
K23 KPC 50.200/P	7032	50	200	200	953608	40	1 p.

During the assembly, every fitting must be supported at each end, and also in the center.
To ensure a correct installation, the couplers must be fixed laterally by 4 bolts M6x16 V4A on each tray end.

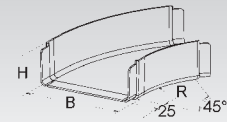

GRP elbow 90°, large radius

pressed, with interlocking coupler

Item ref.	RAL colour	Height	Width B	C	Radius R	EAN code	Weight 100 units pc	Min. pack.
		mm	mm	mm	mm			
K23 KPB 50.100/P	7032	50	100	125	100	953349	30	1 p.
K23 KPB 50.150/P	7032	50	150	200	175	953356	60	1 p.
K23 KPB 50.200/P	7032	50	200	225	200	953363	80	1 p.

During the assembly, every fitting must be supported at each end, and also in the center.
To ensure a correct installation, the couplers must be fixed laterally by 4 bolts M6x16 V4A on each tray end.

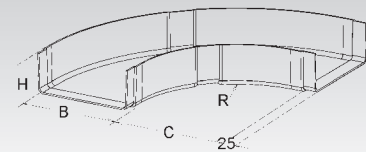

GRP changing elevation

pressed, in 2 pieces, with interlocking coupler

Item ref.	RAL colour	Height	Width B	Height H1	Height H2	Height H3	EAN code	Weight 100 units pc/m	Min. pack.
		mm	mm	mm	mm	mm			
K23 KPET 50.100/P	7032	50	100	160	480	800	954513	180	1 p.
K23 KPET 50.150/P	7032	50	150	160	480	800	954520	184	1 p.
K23 KPET 50.200/P	7032	50	200	160	480	800	954537	259	1 p.

Composed with different pieces, the changing elevation can be mounted in different heights

During the assembly, every fitting must be supported at each end, and also in the center.
To ensure a correct installation, the couplers must be fixed laterally by 4 bolts M6x16 V4A on each tray end.

The part height depends on the height and the configuration used
H1 = 160 mm => L1 = 785 mm (a cut is necessary)
H2 = 480 mm => L2 = 1100 mm
H3 = 800 mm => L3 = 970 mm

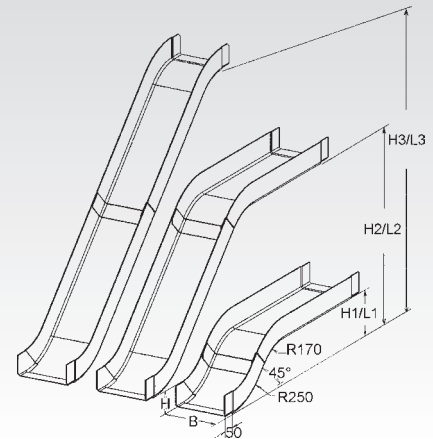
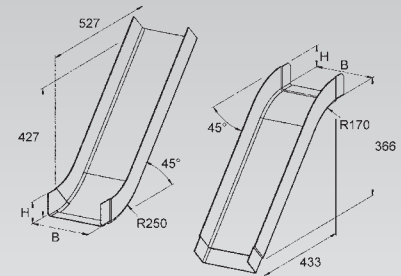

GRP vertical inside elbow

pressed, with interlocking coupler

Item ref.	RAL colour	Height	Width B	EAN code	Weight 100 units pc	Min. pack.
		mm	mm			
K23 KPBI 50.100/P	7032	50	100	954278	40	1 p.
K23 KPBI 50.150/P	7032	50	150	954285	50	1 p.
K23 KPBI 50.200/P	7032	50	200	954292	60	1 p.

During the assembly, every fitting must be supported at each end, and also in the center.
To ensure a correct installation, the couplers must be fixed laterally by 2 bolts M6x16 V4A on each tray end.

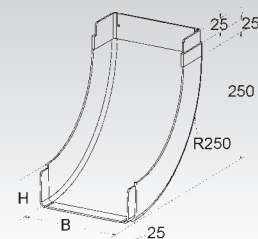

GRP vertical outside elbow

pressed, with interlocking coupler

Item ref.	RAL colour	Height mm	Width B mm	EAN code	Weight 100 units pc	Min. pack.
K23 KPBA 50.100/P	7032	50	100	954216	30	1 p.
K23 KPBA 50.150/P	7032	50	150	954223	40	1 p.
K23 KPBA 50.200/P	7032	50	200	954230	50	1 p.

During the assembly, every fitting must be supported at each end, and also in the center.

To ensure a correct installation, the couplers must be fixed laterally by 4 bolts M6x16 V4A on each tray end.

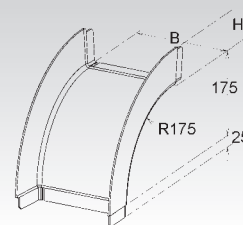

CABLE TRAY SYSTEM KP

GRP cable trays

pultruded, perforated

Item ref.	RAL colour	Height	Width B	Material thickness (th)	EAN code	Weight 100 units m	Min. pack.
		mm	mm	mm			
K23 KPL 80.100	7032	80	100	2,5	952595	180	3 m
K23 KPL 80.150	7032	80	150	2,5	952601	200	3 m
K23 KPL 80.200	7032	80	200	2,5	952618	234	3 m
K23 KPL 80.300	7032	80	300	3,2	952625	355	3 m
K23 KPL 80.100/6	7032	80	100	2,5	952670	180	6 m
K23 KPL 80.150/6	7032	80	150	2,5	952687	200	6 m
K23 KPL 80.200/6	7032	80	200	2,5	952694	234	6 m
K23 KPL 80.300/6	7032	80	300	3,2	952700	355	6 m

Due to the expansion of the material, the following points during installation must be observed :

The supporting systems must not be fixed close to the splice plates

For fixing the cables trays on brackets, you need to drill a 9 mm diameter hole for the fixing of the cable tray base with bolts M6x20 V4A

When fixing the splice plates KPGH..., an expansion distance of about 3 mm must be considered.

The splice plates KPGH.../ KPIH... V4A are not included in the cables trays, please order them separately.

Load diagram : q = load evenly distributed cables (according to DIN EN IEC 61537 standard)

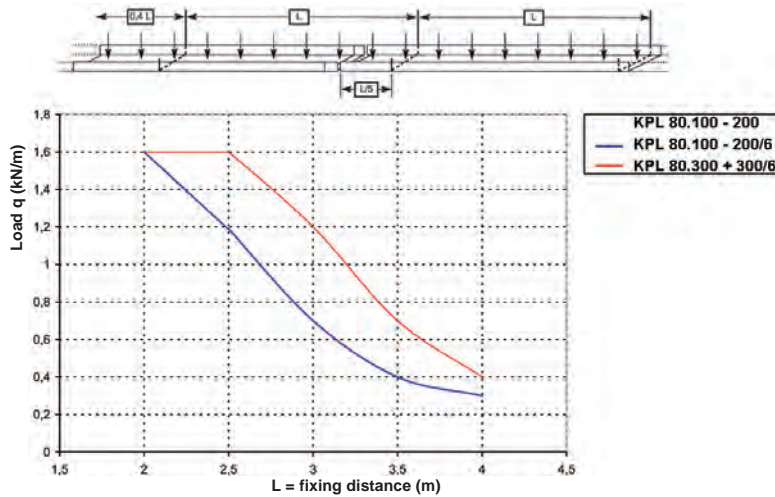

Warning : the deflection is measured with a junction position between 2 cable trays at a distance L/5 from the support. If this distance is not respected, it is necessary to raise the deflection values by approx. 30%.

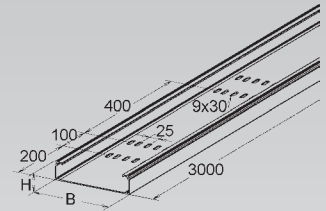

GRP cable trays

pultruded, not perforated

Item ref.	RAL colour	Height	Width B	Material thickness (th)	EAN code	Weight 100 units m	Min. pack.
		mm	mm	mm			
K23 KP 80.100	7032	80	100	2,5	952434	148	3 m
K23 KP 80.150	7032	80	150	2,5	952441	200	3 m
K23 KP 80.200	7032	80	200	2,5	952458	240	3 m
K23 KP 80.300	7032	80	300	3,2	952465	363	3 m
K23 KP 80.100/6	7032	80	100	2,5	952519	148	6 m
K23 KP 80.150/6	7032	80	150	2,5	952526	200	6 m
K23 KP 80.200/6	7032	80	200	2,5	952533	240	6 m
K23 KP 80.300/6	7032	80	300	3,2	952540	363	6 m

Due to the expansion of the material, the following points during installation must be observed :

The supporting systems must not be fixed close to the splice plates

For fixing the cables trays on brackets, you need to drill a 9 mm diameter hole for the fixing of the cable tray base with bolts M6x20 V4A

When fixing the splice plates KPGH..., an expansion distance of about 3 mm must be considered.

The splice plates KPGH.../ KPIH... V4A are not included in the cables trays, please order them separately.

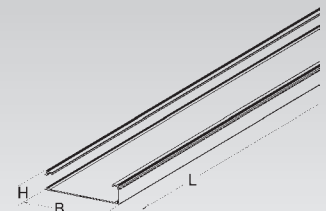

End cap for cable tray

pultruded

Item ref.	RAL colour	Height	Width B	EAN code	Weight 100 units pc	Min. pack.
		mm	mm			
K23 KPKE 80.100	7032	80	100	955428	8	1 p.
K23 KPKE 80.150	7032	80	150	955435	11	1 p.
K23 KPKE 80.200	7032	80	200	955442	13	1 p.
K23 KPKE 80.300	7032	80	300	955459	20	1 p.

for the cable tray ends

Used for: Cable tray H50, H80, KP..., KPL... and cable trunking LFG...

Mounting accessories required : 2 bolts M6x16 V4A (to be ordered separately)

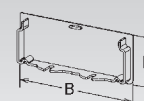

Clipsable splice plate

pultruded, horizontal

Item ref.	RAL colour	Height	EAN code	Weight 100 units	Min. pack.
		mm			
K23 KPGH 80	7032	69	955718	22,5	1 set

for the connection of cable trays and the fittings H80, with splice plates H80 should be clipped on both cable trays sides.

Need: 2 pieces for each cut

During the assembly, an expansion gap of 3 mm for dilatation must be considered.

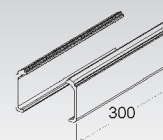

Separator

pultruded

Item ref.	RAL colour	Height	EAN code	Weight 100 units m	Min. pack.
		mm			
K23 KPT 80	7032	65	953134	42	3 m
K23 KPT 80/M	7032	65	953158	42	3 m

to separate cables with different functions and / or to separate voltages

The divider KPT80 is delivered not mounted, it can be fixed in the cable tray with a bolt M 6x16 V4A each meter.

The divider KPT80/M can be delivered pre-mounted (riveted), the position inside the cable tray must be defined in the purchase order.

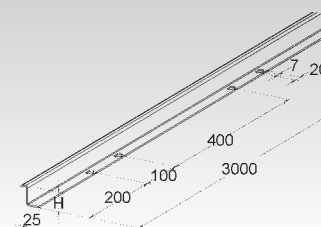

GRP tee junction for cable tray, large radius

pressed, with interlocking coupler

Item ref.	RAL colour	Height	Width B	EAN code	Weight 100 units pc	Min. pack.
		mm	mm			
K23 KPST 80.100/P	7032	80	100	954759	78,0	1 p.
K23 KPST 80.150/P	7032	80	150	967629	78,0	1 p.
K23 KPST 80.200/P	7032	80	200	954766	90,0	1 p.
K23 KPST 80.300/P	7032	80	300	954773	108,5	1 p.

During the assembly, every fitting must be supported at each end, at the cable entry.

To ensure a correct installation, the couplers must be fixed laterally by 4 bolts M6x16 V4A on each tray end.

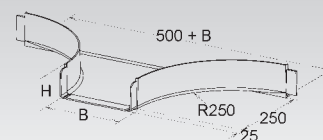

GRP elbow 45°, small radius

pressed, with interlocking coupler

Item ref.	RAL colour	Height	Width B	Radius R	EAN code	Weight 100 units pc	Min. pack.
		mm	mm	mm			
K23 KPC 80.100/P	7032	80	100	100	953615	22	1 p.
K23 KPC 80.150/P	7032	80	150	175	967636	32	1 p.
K23 KPC 80.200/P	7032	80	200	200	953622	45	1 p.
K23 KPC 80.300/P	7032	80	300	225	953639	85	1 p.

The piece is provided with a sleeve riveted on one side only.

During the assembly, every fitting must be supported at each end, at the cable entry.

To ensure a correct installation, the couplers must be fixed laterally by 2 bolts M6x16 V4A on each tray end.

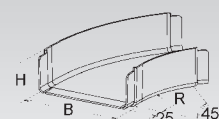

CABLE TRAY SYSTEM KP

GRP elbow 90°, large radius

pressed, with interlocking coupler

Item ref.	RAL colour	Height	Width B	C	Radius R	EAN code	Weight 100 units pc/	Min. pack.
		mm	mm	mm	mm			
K23 KPB 80.100/P	7032	80	100	125	100	953370	41,5	1 p.
K23 KPB 80.150/P	7032	80	150	200	175	967643	65,0	1 p.
K23 KPB 80.200/P	7032	80	200	225	200	953387	90,0	1 p.
K23 KPB 80.300/P	7032	80	300	250	225	953394	170,0	1 p.

During the assembly, every fitting must be supported at each end, and also in the center.
To ensure a correct installation, the couplers must be fixed laterally by 2 bolts M6x16 V4A on each tray end.

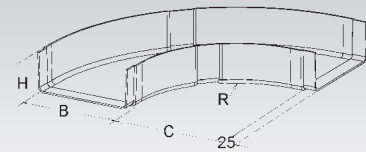

GRP changing elevation

pressed, in 2 pieces, with interlocking coupler

Item ref.	RAL colour	Height	Width B	Height H1	Height H2	Height H3	EAN code	Weight 100 units pc/	Min. pack.
		mm	mm	mm	mm	mm			
K23 KPET 80.100/P	7032	80	100	160	480	800	954544	190	1 p.
K23 KPET 80.150/P	7032	80	150	160	480	800	967650	230	1 p.
K23 KPET 80.200/P	7032	80	200	160	480	800	954551	270	1 p.
K23 KPET 80.300/P	7032	80	300	160	480	800	954568	350	1 p.

Composed with different pieces, the changing elevation can be mounted in different heights

During the assembly, every fitting must be supported at each end, at the cable entry.
To ensure a correct installation, the couplers must be fixed laterally by 2 bolts M6x16 V4A on each tray end.

The part height depends on the height and the configuration used
 H1 = 160 mm => L1 = 785 mm (a cut is necessary)
 H2 = 480 mm => L2 = 1100 mm
 H3 = 800 mm => L3 = 970 mm

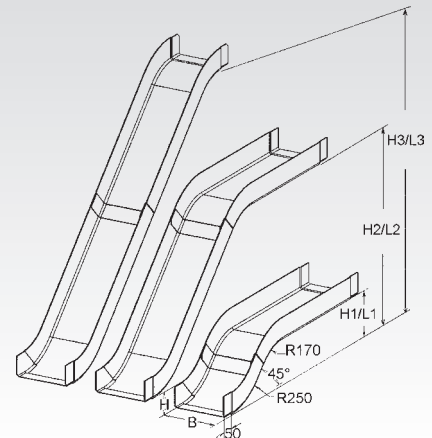
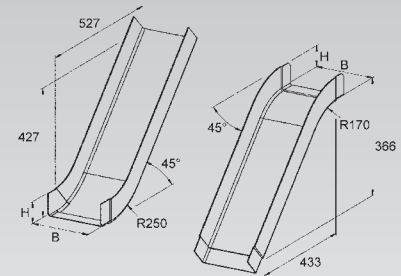

GRP vertical inside elbow

pressed, with interlocking coupler

Item ref.	RAL colour	Height	Width B	EAN code	Weight 100 units pc	Min. pack.
		mm	mm			
K23 KPBI 80.100/P	7032	80	100	954308	50	1 p.
K23 KPBI 80.150/P	7032	80	150	967667	65	1 p.
K23 KPBI 80.200/P	7032	80	200	954315	80	1 p.
K23 KPBI 80.300/P	7032	80	300	954322	102	1 p.

During the assembly, every fitting must be supported at each end, and also in the center.
To ensure a correct installation, the couplers must be fixed laterally by 4 bolts M6x16 V4A on each tray end.

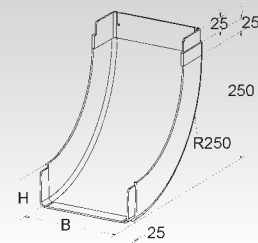

GRP vertical outside elbow

pressed, with interlocking coupler

Item ref.	RAL colour	Height	Width B	EAN code	Weight 100 units pc	Min. pack.
		mm	mm			
K23 KPBA 80.100/P	7032	80	100	954247	40	1 p.
K23 KPBA 80.150/P	7032	80	150	967674	50	1 p.
K23 KPBA 80.200/P	7032	80	200	954254	60	1 p.
K23 KPBA 80.300/P	7032	80	300	954261	80	1 p.

During the assembly, every fitting must be supported at each end, at the cable entry.
To ensure a correct installation, the couplers must be fixed laterally by 2 bolts M6x16 V4A on each tray end.

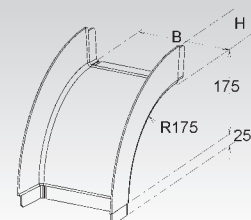

NOTES

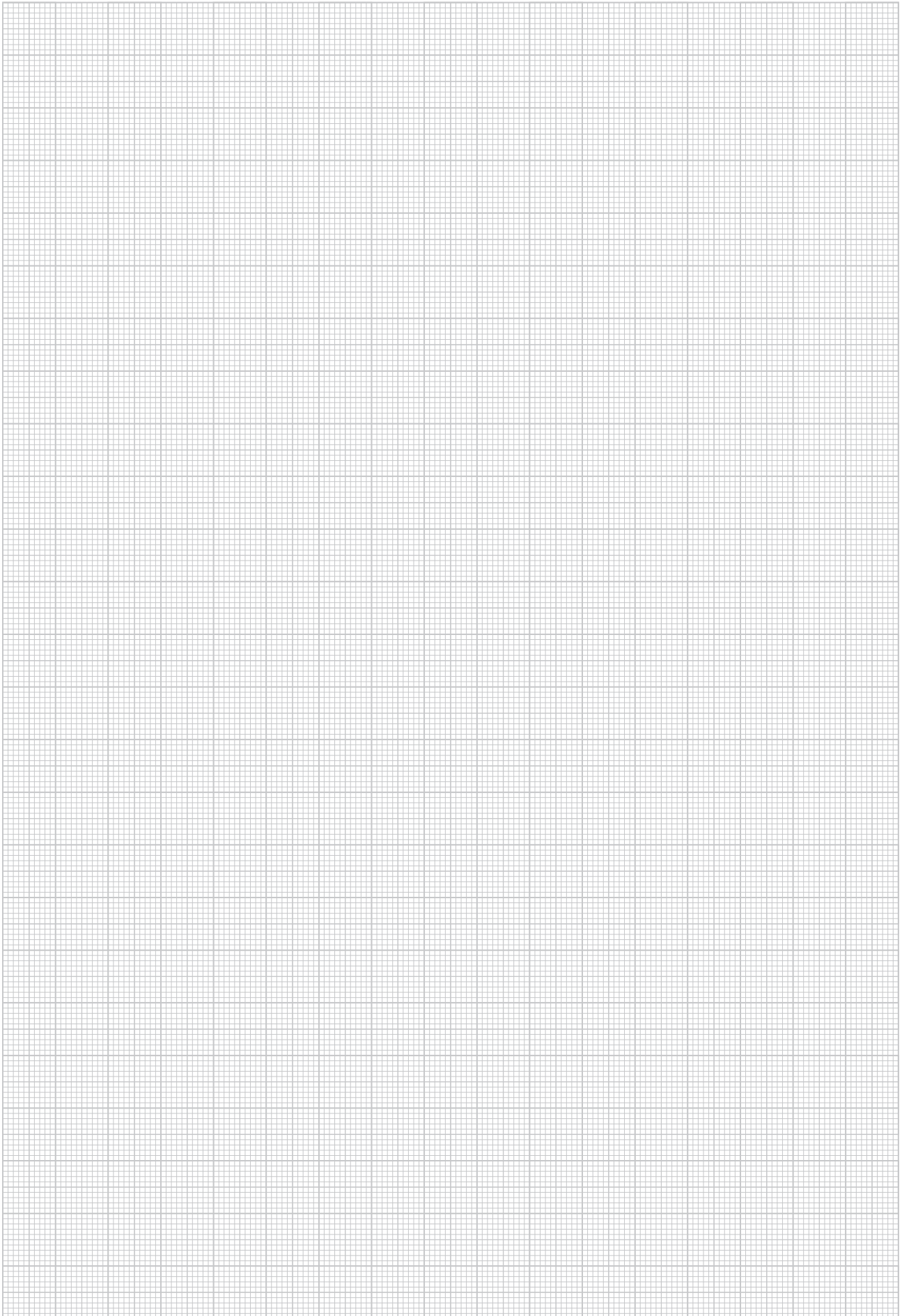

CABLE TRAY SYSTEM COVERS KP

GRP cover for cable tray

pultruded

Item ref.	RAL colour	Width B mm	Material thickness (th) mm	EAN code	Weight 100 units pc/m	Min. pack.
K23 KPD 60	7032	60	2,0	956241	29,1	3 m
K23 KPD 100	7032	100	2,5	956258	52,0	3 m
K23 KPD 150	7032	150	2,5	956265	75,0	3 m
K23 KPD 200	7032	200	2,5	956272	100,0	3 m
K23 KPD 300	7032	300	2,5	956289	145,0	3 m

for cable trays

Used for: GRP cable trays H40, H50 and H80 KP... and KPL... (perforated)

To ensure a correct and strong installation of the cable trays and covers, a minimum distance of 3 mm for dilatation must be considered for both parts.

Fast fix clip of covers. In extreme windy conditions (strong winds, storms for example), we recommend to add cover clips DF...V4A.

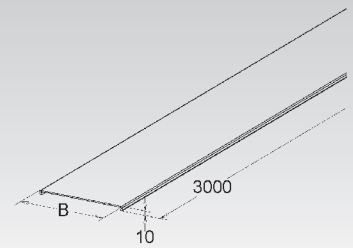

GRP cover for horizontal elbow 45°, small radius

pressed

Item ref.	RAL colour	Width B mm	EAN code	Weight 100 units pc	Min. pack.
K23 KKCD 100	7032	100	956456	12	1 p.
K23 KKCD 150	7032	150	956463	23	1 p.
K23 KKCD 200	7032	200	956470	33	1 p.
K23 KKCD 250	7032	250	956487	50	1 p.
K23 KKCD 300	7032	300	956494	51	1 p.
K23 KKCD 400	7032	400	956500	138	1 p.
K23 KKCD 500	7032	500	956517	150	1 p.
K23 KKCD 600	7032	600	956524	173	1 p.

Used for: Elbow 45° H50, H80 and H110 mm, KKCD... and KPC.../P

Covers are attached by using stainless steel cover clips DF...V4A, DF M... and DFUB... In extreme weather conditions, strong winds, storms for example, the quantity of clips must be increased.

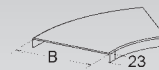

Cover for horizontal elbow 90°, large radius

pressed

Item ref.	RAL colour	Width B mm	EAN code	Weight 100 units pc	Min. pack.
K23 KKBD 100	7032	100	956371	19,5	1 p.
K23 KKBD 150	7032	150	956388	43,0	1 p.
K23 KKBD 200	7032	200	956395	68,0	1 p.
K23 KKBD 250	7032	250	956401	97,0	1 p.
K23 KKBD 300	7032	300	956418	115,0	1 p.
K23 KKBD 400	7032	400	956425	241,0	1 p.
K23 KKBD 500	7032	500	956432	334,0	1 p.
K23 KKBD 600	7032	600	956449	403,0	1 p.

Used for: Horizontal elbow 90°, large radius, H50, H80 and H110, KKB... and KPB.../P

Covers are attached by using stainless steel cover clips DF...V4A, DF M... and DFUB... In extreme weather conditions, strong winds, storms for example, the quantity of clips must be increased.



GRP cover for vertical inside elbow

pressed

Item ref.	RAL colour	Height mm	Width B mm	EAN code	Weight 100 units pc	Min. pack.
K23 KKBID 50.050	7032	50	50	956814	5	1 p.
K23 KKBID 50.100	7032	50	100	956821	20	1 p.
K23 KKBID 50.150	7032	50	150	956838	42	1 p.
K23 KKBID 50.200	7032	50	200	956845	50	1 p.
K23 KKBID 50.300	7032	50	300	956852	63	1 p.

Used for: Vertical inside elbow 50 mm high, KKBID... and KPBI.../P

Covers are attached by using stainless steel cover clips DF...V4A, DF M... and DFUB... In extreme weather conditions, strong winds, storms for example, the quantity of clips must be increased.

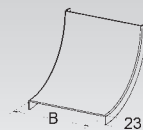

GRP cover for vertical inside elbow

pressed

Item ref.	RAL colour	Height mm	Width B mm	EAN code	Weight 100 units pc	Min. pack.
K23 KKBID 80.100	7032	80	100	956869	18,0	1 p.
K23 KKBID 80.150	7032	80	150	956876	24,5	1 p.
K23 KKBID 80.200	7032	80	200	956883	33,0	1 p.
K23 KKBID 80.250	7032	80	250	956890	40,0	1 p.
K23 KKBID 80.300	7032	80	300	956906	45,5	1 p.
K23 KKBID 80.400	7032	80	400	956913	61,0	1 p.
K23 KKBID 80.500	7032	80	500	956920	73,0	1 p.
K23 KKBID 80.600	7032	80	600	956937	95,0	1 p.

Used for: Vertical inside elbow 80 mm high, KKBID... and KPBI.../P

Covers are attached by using stainless steel cover clips DF...V4A, DF M... and DFUB... In extreme weather conditions, strong winds, storms for example, the quantity of clips must be increased.

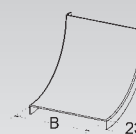

GRP cover for vertical outside elbow

pressed

Item ref.	RAL colour	Height mm	Width B mm	EAN code	Weight 100 units pc	Min. pack.
K23 KKBAD 50.050	7032	50	50	956623	7,8	1 p.
K23 KKBAD 50.100	7032	50	100	956630	10,0	1 p.
K23 KKBAD 50.150	7032	50	150	956647	42,0	1 p.
K23 KKBAD 50.200	7032	50	200	956654	51,0	1 p.
K23 KKBAD 50.300	7032	50	300	956661	65,0	1 p.

Used for: Vertical outside elbow H50 mm, KKBA... and KPBA.../P

Covers are attached by using stainless steel cover clips DF...V4A, DF M... and DFUB... In extreme weather conditions, strong winds, storms for example, the quantity of clips must be increased.

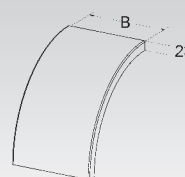

GRP cover for vertical outside elbow

pressed

Item ref.	RAL colour	Height mm	Width B mm	EAN code	Weight 100 units pc	Min. pack.
K23 KKBAD 80.100	7032	80	100	956678	29,5	1 p.
K23 KKBAD 80.150	7032	80	150	956685	39,0	1 p.
K23 KKBAD 80.200	7032	80	200	956692	51,0	1 p.
K23 KKBAD 80.250	7032	80	250	956708	61,0	1 p.
K23 KKBAD 80.300	7032	80	300	956715	72,0	1 p.
K23 KKBAD 80.400	7032	80	400	956722	90,0	1 p.
K23 KKBAD 80.500	7032	80	500	956739	120,0	1 p.
K23 KKBAD 80.600	7032	80	600	956746	136,0	1 p.

Used for: Vertical outside elbow H80 mm, KKBA... and KPBA.../P

Covers are attached by using stainless steel cover clips DF...V4A, DF M... and DFUB... In extreme weather conditions, strong winds, storms for example, the quantity of clips must be increased.

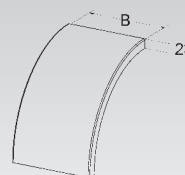

GRP cover for changing elevation

pressed

Item ref.	RAL colour	Height mm	Width B mm	EAN code	Weight 100 units pc	Min. pack.
K23 KKETD 50.100	7032	50	100	957002	20	1 p.
K23 KKETD 50.150	7032	50	150	957019	41	1 p.
K23 KKETD 50.200	7032	50	200	957026	40	1 p.
K23 KKETD 50.300	7032	50	300	957033	60	1 p.

- 1 KKETD is composed of :
- 1 GRP cover for inside elbow
 - 1 GRP cover for outside elbow

Used for: Changing elevation H50 mm KKET... and KPET.../P

Covers are attached by using stainless steel cover clips DF...V4A, DF M... and DFUB... In extreme weather conditions, strong winds, storms for example, the quantity of clips must be increased.

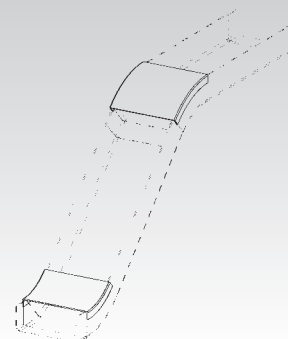

CABLE TRAY SYSTEM COVERS KP

GRP cover for changing elevation

pressed

Item ref.	RAL colour	Height mm	Width B mm	EAN code	Weight 100 units pc	Min. pack.
K23 KKETD 80.100	7032	80	100	957040	23,5	1 p.
K23 KKETD 80.150	7032	80	150	957057	31,7	1 p.
K23 KKETD 80.200	7032	80	200	957064	40,5	1 p.
K23 KKETD 80.250	7032	80	250	957071	44,0	1 p.
K23 KKETD 80.300	7032	80	300	957088	47,0	1 p.
K23 KKETD 80.400	7032	80	400	957095	61,0	1 p.
K23 KKETD 80.500	7032	80	500	957101	98,0	1 p.
K23 KKETD 80.600	7032	80	600	957118	120,0	1 p.

1 KKETD is composed of :
 - 1 GRP cover for inside elbow
 - 1 GRP cover for outside elbow

Used for: Changing elevation H50 mm KKET... and KPET.../P

Covers are attached by using stainless steel cover clips DF...V4A, DF M... and DFUB... In extreme weather conditions, strong winds, storms for example, the quantity of clips must be increased.

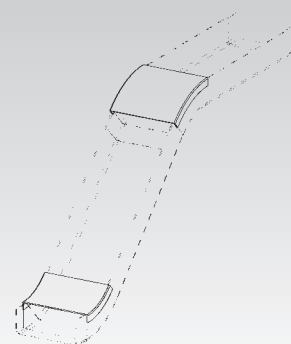

GRP cover for tee junction, large radius

pressed, with interlocking coupler

Item ref.	RAL colour	Width B mm	EAN code	Weight 100 units pc	Min. pack.
K23 KKSTD 100	7032	100	957187	35	1 p.
K23 KKSTD 150	7032	150	957194	42	1 p.
K23 KKSTD 200	7032	200	957200	52	1 p.
K23 KKSTD 250	7032	250	957217	63	1 p.
K23 KKSTD 300	7032	300	957224	65	1 p.
K23 KKSTD 400	7032	400	957231	78	1 p.
K23 KKSTD 500	7032	500	957248	100	1 p.
K23 KKSTD 600	7032	600	957255	118	1 p.

Used for: Cover for tee junction for H50, H80 and H110 mm, KKST... and KPST.../P

Covers are attached by using stainless steel cover clips DF...V4A, DF M... and DFUB... In extreme weather conditions, strong winds, storms for example, the quantity of clips must be increased.

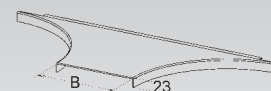

Tee junction cover, small radius

pressed, with interlocking coupler

Item ref.	RAL colour	Width B mm	EAN code	Weight 100 units pc	Min. pack.
K23 KKSSD 50	7032	50	957262	5,0	1 p.
K23 KKSSD 100	7032	100	957279	8,0	1 p.
K23 KKSSD 150	7032	150	957286	9,5	1 p.
K23 KKSSD 200	7032	200	957293	13,0	1 p.
K23 KKSSD 250	7032	250	957309	14,5	1 p.
K23 KKSSD 300	7032	300	957316	15,5	1 p.

Used for: Tee junction for H50 and H80 mm, KKSS... and KPSS.../P

Covers are attached by using stainless steel cover clips DF...V4A, DF M... and DFUB... In extreme weather conditions, strong winds, storms for example, the quantity of clips must be increased.

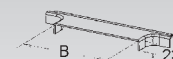

GRP cover for right hand reduction

pressed

Item ref.	RAL colour	Width B mm	EAN code	Weight 100 units pc	Min. pack.
K23 KKRRD 200	7032	200	957378	50,5	1 p.
K23 KKRRD 300	7032	300	957385	79,0	1 p.
K23 KKRRD 400	7032	400	957392	119,0	1 p.
K23 KKRRD 500	7032	500	957408	131,0	1 p.
K23 KKRRD 600	7032	600	957415	160,0	1 p.

Used for: Right hand reduction H50, H80 and H110 mm, KKRR...

Covers are attached by using stainless steel cover clips DF...V4A, DF M... and DFUB... In extreme weather conditions, strong winds, storms for example, the quantity of clips must be increased.

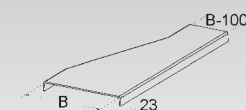

GRP cover for left hand reduction

pressed

Item ref.	RAL colour	Width B mm	EAN code	Weight 100 units pc	Min. pack.
K23 KKRLD 200	7032	200	957323	49	1 p.
K23 KKRLD 300	7032	300	957330	75	1 p.
K23 KKRLD 400	7032	400	957347	110	1 p.
K23 KKRLD 500	7032	500	957354	147	1 p.
K23 KKRLD 600	7032	600	957361	160	1 p.

Used for: Reduction H50, 80 and 110 mm, KKRL...

Covers are attached by using stainless steel cover clips DF...V4A, DF M... and DFUB... In extreme weather conditions, strong winds, storms for example, the quantity of clips must be increased.

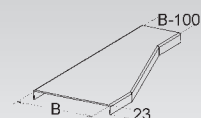

Cover fixing clip

stainless steel

Item ref.	Height mm	EAN code	Weight 100 units pc.	Min. pack.
E4 DF 50 E4	55	957873	1,7	50 p.
E4 DF 80 E4	85	957880	2,1	50 p.

for fixing the cables tray covers and fittings

Used for: Cable tray cover KKD... and KPD...

Cover for fittings KKCD..., KKBD..., KKWD..., KKBAD..., KKBID..., KKETD..., KKSTD..., KKSSD..., KKRLD... and KKRRD...

Under normal conditions, it is recommended to mount 1 clip each meter alternatively every 3 meters. Under extreme weather conditions, such as strong winds or storms, the quantity of clips must be increased.



Cover fixing

Item ref.	EAN code	Weight 100 units pc.	Min. pack.
K01 DF M	957927	0,2	50 p.

Used for: Cover for cable tray KKD... and KPD...

Cover for fittings KKCD..., KKBD..., KKWD..., KKBAD..., KKBID..., KKETD..., KKSTD..., KKSSD..., KKRLD... und KKRRD...

For fixing the cover, it is necessary to drill a 8,2 mm diameter hole for the diameter. In extreme weather conditions such as strong winds, for example, the quantity of clips must be increased.

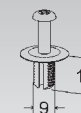

Cover fixing

Item ref.	EAN code	Weight 100 units	Min. pack.
★ E4 DFUB 5.5X19 E4	062065	0,64	50 p.

Used for: Cover for cable tray KKD... and KPD...

Cover for fittings KKCD..., KKBD..., KKWD..., KKBAD..., KKBID..., KKETD..., KKSTD..., KKSSD..., KKRLD... und KKRRD...

For fixing the cover, it is necessary to drill a 8,2 mm diameter hole for the diameter. In extreme weather conditions such as strong winds, for example, the quantity of clips must be increased.

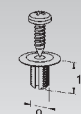

CABLE TRAY SYSTEM ACCESSOIRES KP

Rack for cables

pressed, standard

Item ref.	RAL colour	Width B mm	EAN code	Weight 100 units pc	Min. pack.
K23 KR 100	7032	100	955466	2,4	1 p.
K23 KR 150	7032	150	955473	3,1	1 p.
K23 KR 200	7032	200	955480	4,0	1 p.
K23 KR 250	7032	250	955497	6,0	1 p.
K23 KR 300	7032	300	955503	6,7	1 p.
K23 KR 400	7032	400	955510	11,0	1 p.
K23 KR 500	7032	500	955527	16,0	1 p.
K23 KR 600	7032	600	955534	20,0	1 p.
K23 KR 100/M	7032	100	955541	2,4	1 p.
K23 KR 150/M	7032	150	955558	3,1	1 p.
K23 KR 200/M	7032	200	955565	4,0	1 p.
K23 KR 250/M	7032	250	955572	6,0	1 p.
K23 KR 300/M	7032	300	955589	6,7	1 p.
K23 KR 400/M	7032	400	955596	11,0	1 p.
K23 KR 500/M	7032	500	955602	16,0	1 p.
K23 KR 600/M	7032	600	955619	20,0	1 p.

for fixing the cables with cable ties in the vertical rack

The rack for cables KR is delivered not mounted and must be screwed on the cable tray base with 2 bolts M...V4A at each meter.

The rack for cables KR.../M can be delivered pre-mounted (riveted), the position must be defined in the purchase order.

Used for: Cable tray H50, H80 and H110 mm, KK..., KKL..., KP..., KPL...

For a wall or ceiling mounting, the cable tray supports must be adjusted properly in order to obtain all cable trays on a straight line.

The mounting straps must be ordered separately

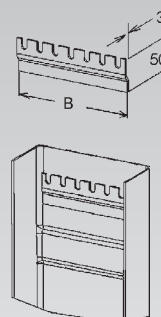

Separating stud

pultruded

Item ref.	EAN code	Weight 100 units m	Min. pack.
K01 TB	957934	1	1 p.

for an easy mounting of cables and connections

Not suitable when the cable tray is mounted vertically (not horizontally)

When mounting the separating stud, it is necessary to drill a 10 mm hole diameter in the base.

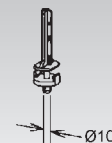

Dome head bolt

Included nut and washer

Item ref.	Thread M	Length L mm	EAN code	Weight 100 units pc	Min. pack.
E4 FKM 6X16 E4	6	16	962693	1,2	100 p.
E4 FKM 6X20 E4	6	20	962709	1,4	100 p.

Also named M6x16V4A for FKM 6x16 E4, M6x20V4A for FKM 6x20 E4, M8x20PA6 for FKM 8x20 K01, M10x30V4A for SKM 10x30 E4



Dome head bolt

Included nut and washer

Item ref.	Thread M	Length L mm	EAN code	Weight 100 units pc	Min. pack.
K01 FKM 8X20 K01	8	20	962716	0,4	100 p.

Also named M6x16V4A for FKM 6x16 E4, M6x20V4A for FKM 6x20 E4, M8x20PA6 for FKM 8x20 K01, M10x30V4A for SKM 10x30 E4



Hexagon head bolt

Included nut and washer

Item ref.	Thread M	Length L mm	EAN code	Weight 100 units pc	Min. pack.
E4 SKM 10X30 E4	10	30	962730	4,5	100 p.
E4 SKM 10X40 E4	10	40	962747	5,1	100 p.

Also named M6x16V4A for FKM 6x16 E4, M6x20V4A for FKM 6x20 E4, M8x20PA6 for FKM 8x20 K01, M10x30V4A for SKM 10x30 E4



NOTES

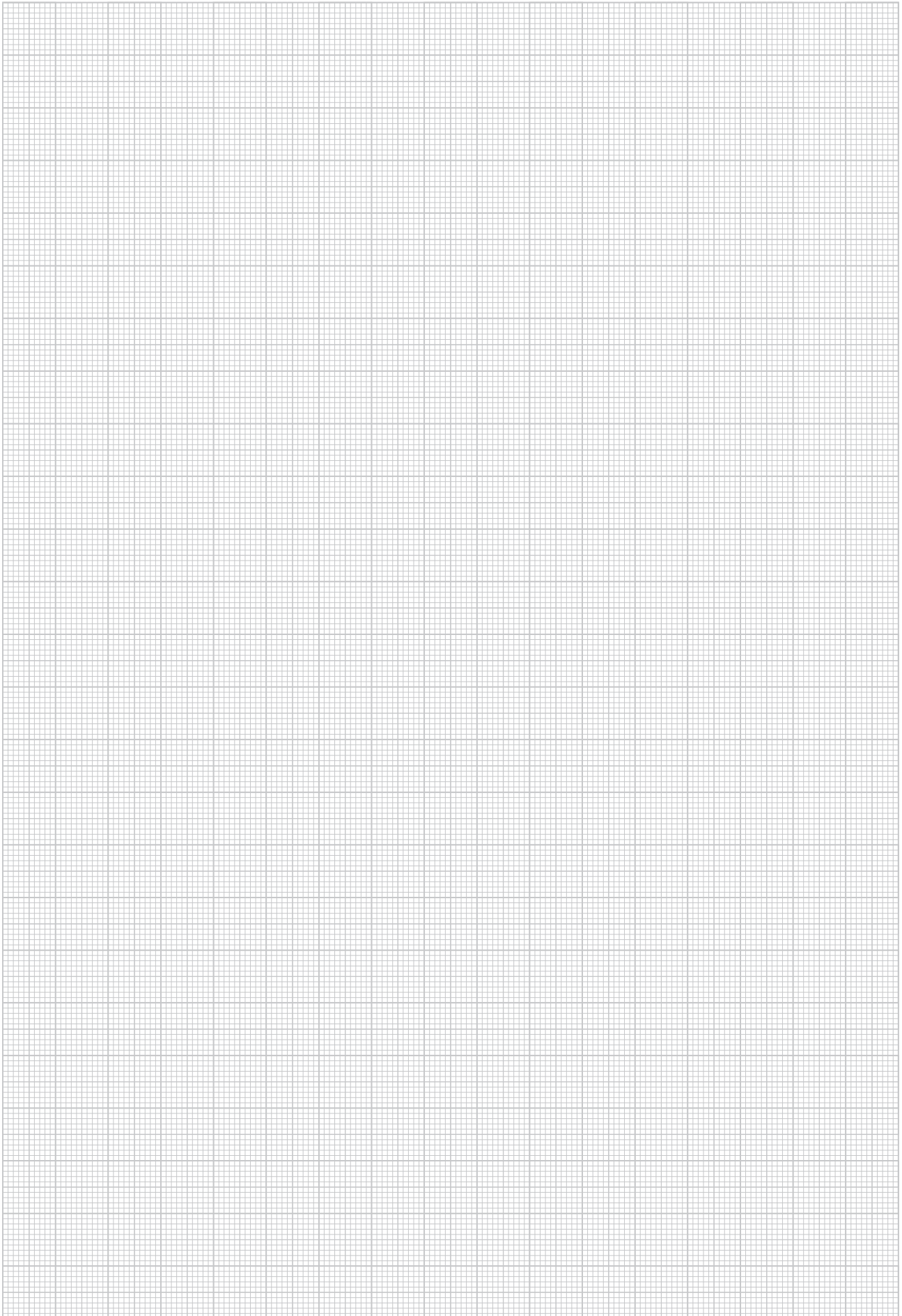

System
UL

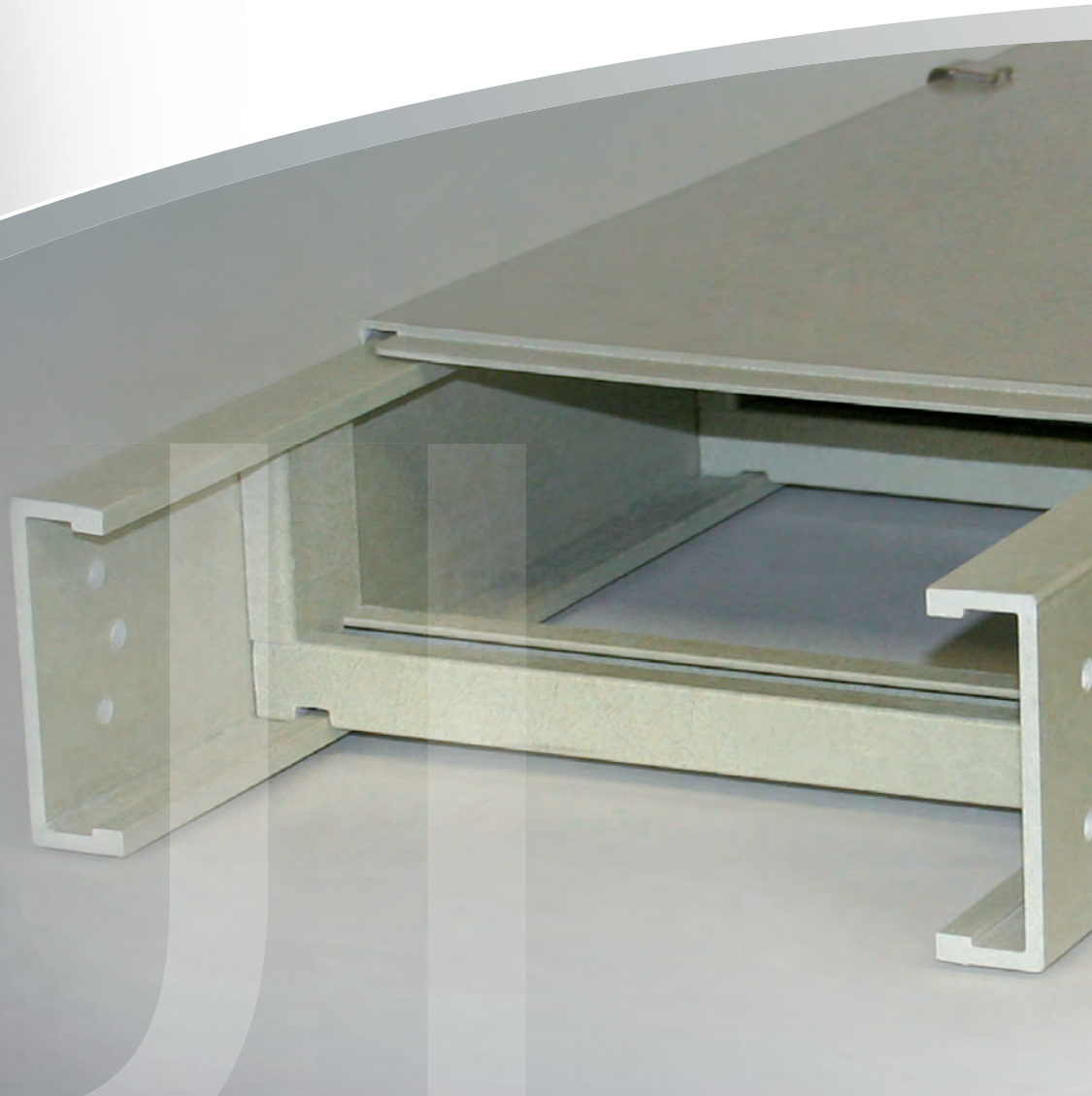

Cable ladder systems available in height    

Cable ladder

Covers

Divider

Accessoires

Fittings

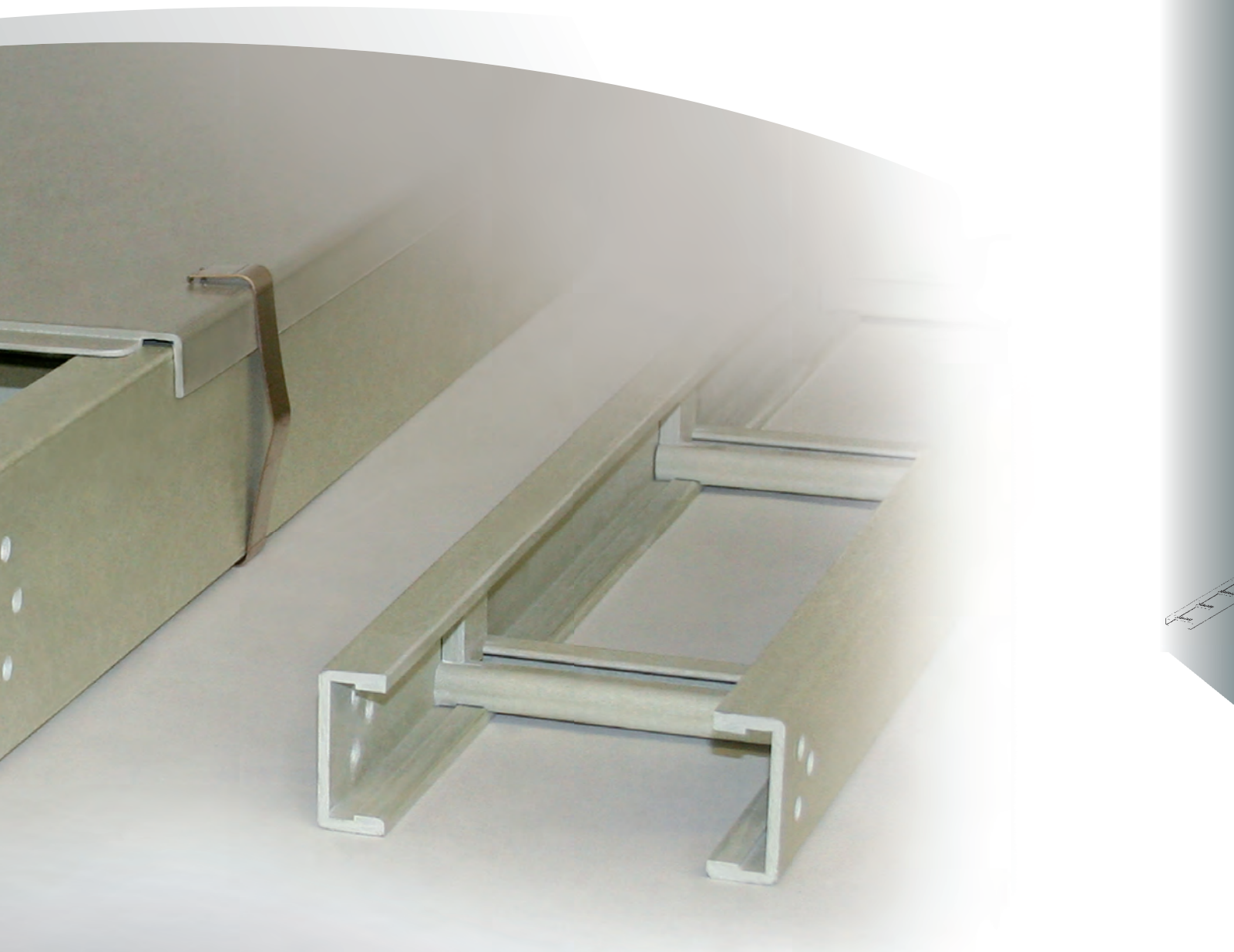

To support important quantities of cables with large diameter, EBO Systems propose the cable ladder in Glass Reinforced polyester GRP, with a support distance of up 6 m. The EBO Systems cable ladder allows to meet the needs in the industry such as nuclear and thermal power plants but also in the oil and gas industry.

The unique patented clip-in rungs assembly, without metallic or thermoplastic parts who weak the cables ladders, the cable ladder EBO Systems is the only one 100% GRP and could be easily assembled close to customers.

CABLE LADDER SYSTEM UL

Available siderail heights



SYSTEM	DESCRIPTION	UL	53	80	100	150
SYSTEM	GRP-Cable Ladder, pultruded	UL	76	80	84	89
ACCESSORIES	GRP-Endcap, pressed	ULKE	76	80	84	89
	GRP-Splice plate, horizontal	ULGH	76	80	85	90
	Stainless steel-Splice plate, horizontal	ULIH	77	81	85	90
	GRP-Divider, pressed	ULTL	77	81	85	90
	GRP-T-, pultruded	ULTE	77	81	85	90
	GRP-Cross, pultruded	ULX	77	81	86	91
	GRP-Elbow 90°, pultruded	ULB	78	82	86	91
	GRP-Elbow, pultruded, vertical	ULBA	78	82	87	92
	GRP-Reducers, pultruded	ULRU	78	82	87	92
	GRP-Splice plate, pressed, vertical	ULGV	79	83	87	92
	Stainless steel-Splice plate, vertical	ULIV	79	83	88	93
	Cover clips	DF				96
	Vertical clamp	ULKV				96
★ NEW	Cover fix	DFUB				97*
	Cover clamp	DFW				97
	GRP-Hold down clamp	ULKG				98*
	Hold down clamp	ULKH				98*
	Bolt	BKM				98*
	Dome head bolt	FKM				98*
	Hexagon head bolt	SKM				98*
	Cover fixing insert	DF M				99*
	Vertical clamp	WWU				99*
	Fork-type self-locking plier	ULP				99*

Covers for cables ladders UL systems are available from page 94.

* suitable for all heights

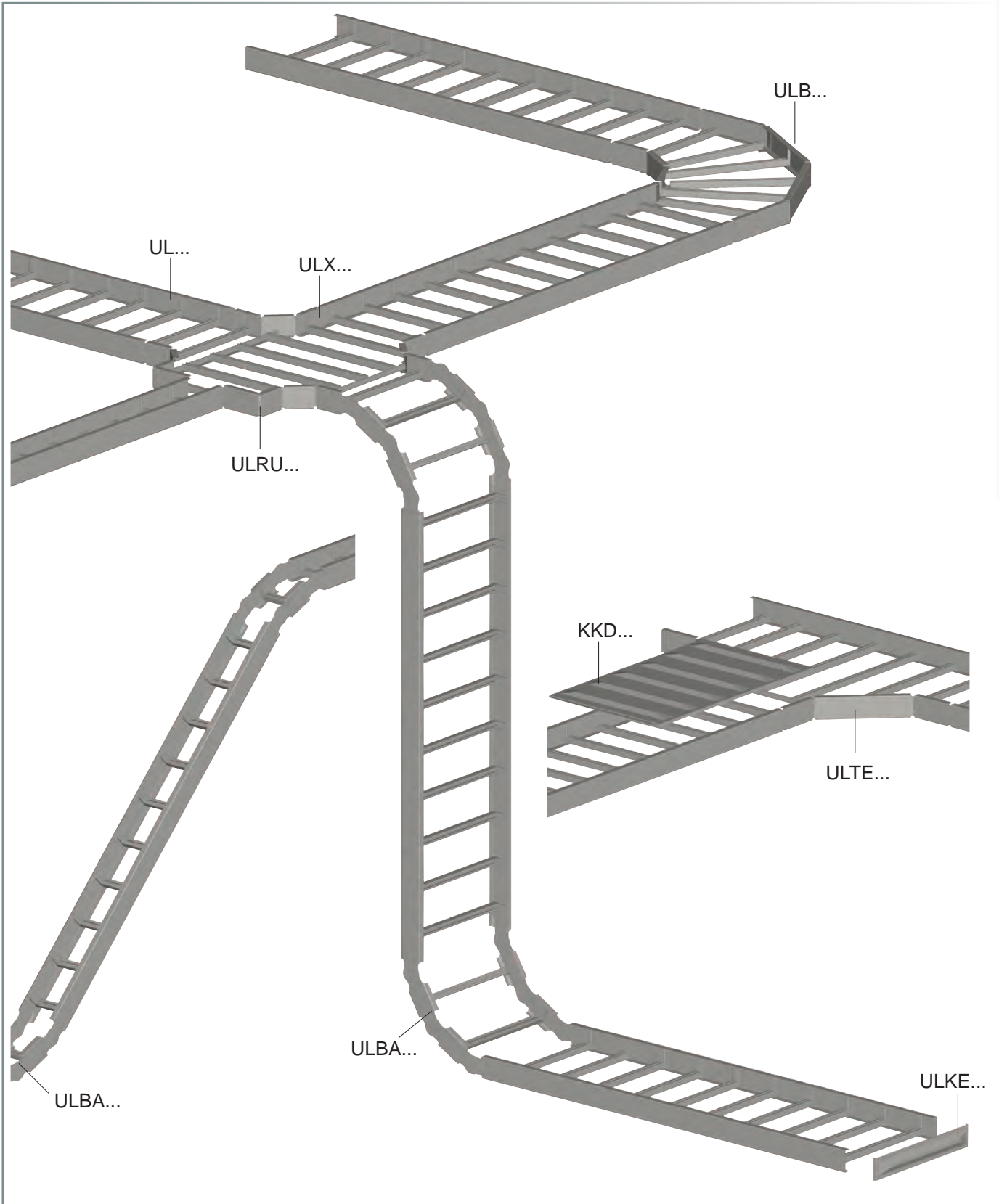

CABLE LADDER SYSTEM UL

GRP cable ladders

pultruded, not perforated rungs

Item ref.	RAL colour	Height	Width B	Material thickness (th)	Side perforations	EAN code	Weight 100 units	Min. pack.	
		mm	mm	mm	mm		m		
K23	UL 53.150/3	7032	53	150	4	6,5 x 20	957958	108,7	3 m
K23	UL 53.200/3	7032	53	200	4	6,5 x 20	957972	116,0	3 m
K23	UL 53.300/3	7032	53	300	4	6,5 x 20	957996	131,0	3 m
K23	UL 53.400/3	7032	53	400	4	6,5 x 20	958016	145,0	3 m
K23	UL 53.500/3	7032	53	500	4	6,5 x 20	958030	160,0	3 m
K23	UL 53.600/3	7032	53	600	4	6,5 x 20	958054	175,0	3 m
K23	UL 53.200	7032	53	200	4	6,5 x 20	957965	116,0	6 m
K23	UL 53.300	7032	53	300	4	6,5 x 20	957989	131,0	6 m
K23	UL 53.400	7032	53	400	4	6,5 x 20	958009	145,0	6 m
K23	UL 53.500	7032	53	500	4	6,5 x 20	958023	160,0	6 m
K23	UL 53.600	7032	53	600	4	6,5 x 20	958047	175,0	6 m

The cables ladders have the advantage to be 100% GRP (Glass Reinforced Polyester), thanks to unique patented clip-in rungs assembly, without metallic or thermoplastic parts. The cables ladders are delivered with non perforated rungs. However the option of perforated rungs is still possible, please contact us.

Load diagram : q = load evenly distributed cables (according to DIN EN IEC 61537 standard)

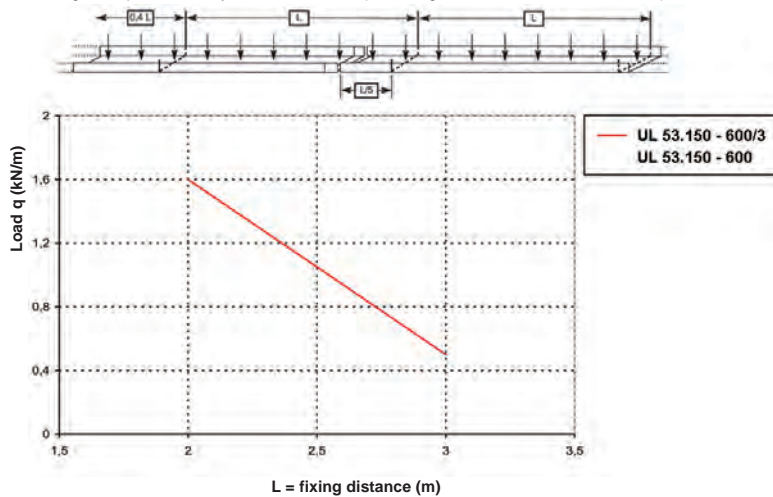

Warning : the deflection is measured with a junction position between 2 cable trays at a distance L/5 from the support. If this distance is not respected, it is necessary to raise the deflection values by approx. 30%.

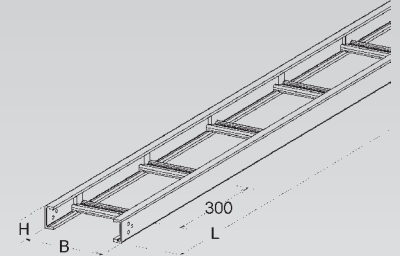

End cap for GRP cable ladder

pultruded

Item ref.	RAL colour	Height	Width B	EAN code	Weight 100 units	Min. pack.	
		mm	mm		pc		
K23	ULKE 53.150	7032	53	150	965748	5,6	1 p.
K23	ULKE 53.200	7032	53	200	965755	7,0	1 p.
K23	ULKE 53.300	7032	53	300	965762	9,8	1 p.
K23	ULKE 53.400	7032	53	400	965779	12,6	1 p.
K23	ULKE 53.500	7032	53	500	965786	15,4	1 p.
K23	ULKE 53.600	7032	53	600	965793	18,2	1 p.

Used for: Cable ladders UL...H53 L3 and UL...H53 L6

Mounting accessories required : 2 bolts M6x16 V4A (to be ordered separately)

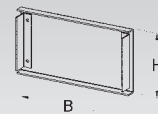

GRP horizontal splice plate

pressed, horizontal

Item ref.	RAL colour	Height	Length L	EAN code	Weight 100 units	Min. pack.	
		mm	mm				
K23	ULGH 53	7032	45	190	960156	8,5	1 set

for connecting cable ladders and fittings H..., with splice plates

Need: 2 pieces for each cut, to be ordered separately

When fixing the splice plates ULIH... and ULGH..., an expansion distance of about 3 mm must be considered.

To ensure a correct installation, the stainless steel splice plates must be fixed on each cable ladder end with 8 bolts M6x16V4A and the GRP splice plates must be fixed with 8 bolts M6x20V4A (must be ordered separately)

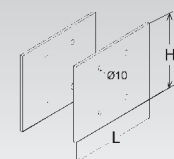

Horizontal stainless steel splice plate

horizontal

Item ref.	Height mm	perforation mm	For oblong perforations LL mm	EAN code	Weight 100 units	Min. pack.
E4 ULIH 53 E4	45	Ø 8	20x8	960194	6,1	1 set

for horizontal changes of directions and for the connection of cable ladders and fittings H53

Mount cable ladders with a space of 3 mm minimum

The holes in the splice plates ensure a solid fixing and allow the GRP material expansion.

During the assembly, please verify that the splice plates oblong holes are located on the same side as the supporting bracket. To help fixing the stainless steel splice plates ULIH, we recommend to use a fork-type self locking plier ULP.

To ensure a correct installation, the stainless steel splice plates must be fixed on each cable ladder end with 8 bolts M6x16V4A and the GRP splice plates must be fixed with 8 bolts M6x20V4A (must be ordered separately)

53

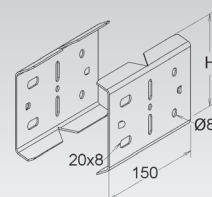

GRP separator

pressed

Item ref.	RAL colour	Height mm	EAN code	Weight 100 units m	Min. pack.
K23 ULTL 53	7032	30	958511	60	3 m

to separate cables with different functions and / or to separate voltages

The GRP cover is fixed with self-tapping screws which are screwed in the ladder siderails and on the cover return flange or with rivets through the ladder siderails.

53

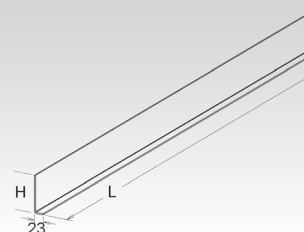

GRP tee junction for cable ladder

pultruded, not perforated rungs

Item ref.	RAL colour	Height mm	Width B mm	EAN code	Weight 100 units pc	Min. pack.
E4 K23 ULTE 53.150	7032	53	150	959235	550	1 p.
E4 K23 ULTE 53.200	7032	53	200	959242	590	1 p.
E4 K23 ULTE 53.300	7032	53	300	959259	620	1 p.
E4 K23 ULTE 53.400	7032	53	400	959266	720	1 p.
E4 K23 ULTE 53.500	7032	53	500	959273	760	1 p.
E4 K23 ULTE 53.600	7032	53	600	959280	830	1 p.

The fittings are delivered with non-perforated rungs. However the option with perforated rungs is still possible, please ask us.

The siderails are made in pultruded GRP. The splices plates are available in GRP, or in stainless steel, please specify the material when ordering.

During assembly, all the fittings must be supported at every cables entry, add a centrale support for all fittings with radius greater than 250 mm, and/or with width greater than 400 mm

To ensure a correct installation, the stainless steel splice plates must be fixed on each cable ladder end with 8 bolts M6x16V4A and the GRP splice plates must be fixed with 8 bolts M6x20V4A (must be ordered separately)

The splice plates ULGH 53/ ULIH 53 V4A are not included in the cables ladders, please order them separately.

53

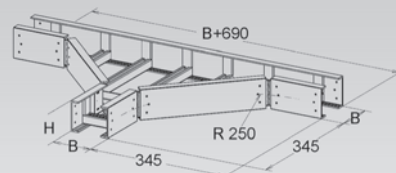

GRP cross for cable ladder

pultruded, not perforated rungs

Item ref.	RAL colour	Height mm	Width B mm	B+D mm	EAN code	Weight 100 units pc	Min. pack.
E4 K23 ULX 53.150	7032	53	150	—	959570	687,5	1 p.
E4 K23 ULX 53.200	7032	53	200	—	959587	738,0	1 p.
E4 K23 ULX 53.300	7032	53	300	—	959594	775,0	1 p.
E4 K23 ULX 53.400	7032	53	400	—	959600	900,0	1 p.
E4 K23 ULX 53.500	7032	53	500	—	959617	950,0	1 p.
E4 K23 ULX 53.600	7032	53	600	—	959624	1.050,0	1 p.

The fittings are delivered with non-perforated rungs. However the option with perforated rungs is still possible, please ask us.

The siderails are made in pultruded GRP. The splices plates are available in GRP, or in stainless steel, please specify the material when ordering.

During assembly, all the fittings must be supported at every cables entry, add a centrale support for all fittings with radius greater than 250 mm, and/or with width greater than 400 mm

To ensure a correct installation, the stainless steel splice plates must be fixed on each cable ladder end with 8 bolts M6x16V4A and the GRP splice plates must be fixed with 8 bolts M6x20V4A (must be ordered separately)

The splice plates ULGH 53/ ULIH 53 V4A are not included in the cables ladders, please order them separately.

53

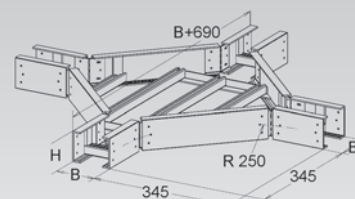

CABLE LADDER SYSTEM UL

GRP elbow 90°

pultruded, not perforated rungs

Item ref.	RAL colour	Height	Width B	EAN code	Weight 100 units pc	Min. pack.
		mm	mm			
E4 K23 ULB 53.150	7032	53	150	958559	160	1 p.
E4 K23 ULB 53.200	7032	53	200	958566	180	1 p.
E4 K23 ULB 53.300	7032	53	300	958573	200	1 p.
E4 K23 ULB 53.400	7032	53	400	958580	270	1 p.
E4 K23 ULB 53.500	7032	53	500	958597	310	1 p.
E4 K23 ULB 53.600	7032	53	600	958603	350	1 p.

The fittings are delivered with non-perforated rungs. However the option with perforated rungs is still possible, please ask us.

The siderails are made in pultruded GRP. The splices plates are available in GRP, or in stainless steel, please specify the material when ordering.

During the installation, you must take care to position a support under the elbow at each cable ladder end.

If the bending radius is higher than 250 mm and if the width of cable ladder is higher than 400 mm, an additional intermediary support is then necessary.

The metallic splice plates must be fixed at each cable ladder end with 4 bolts M 6x20 V4A (to be ordered separately).

Available in radius 250 mm

The splice plates ULGH 53/ ULIH 53 V4A are not included in the cables ladders, please order them separately.

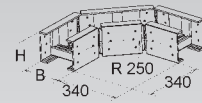

GRP adjustable elbow

pultruded, with integrated splice plates, not perforated rungs

Item ref.	RAL colour	Height	Width B	EAN code	Weight 100 units pc	Min. pack.
		mm	mm			
E4 K23 ULBA 53.150	7032	53	150	958894	80	1 p.
E4 K23 ULBA 53.200	7032	53	200	958900	82	1 p.
E4 K23 ULBA 53.300	7032	53	300	958917	86	1 p.
E4 K23 ULBA 53.400	7032	53	400	958924	91	1 p.
E4 K23 ULBA 53.500	7032	53	500	958931	95	1 p.
E4 K23 ULBA 53.600	7032	53	600	958948	100	1 p.

The fittings are delivered with non-perforated rungs. However the option with perforated rungs is still possible, please ask us.

The siderails are made in pultruded GRP. The splices plates are available in GRP, or in stainless steel, please specify the material when ordering.

In order to guarantee a conform assembly, the metallic splice plates must be fixed at each cable ladder end with 4 bolts M 6 x16 V4A and the composite splice plates must be fixed at each cable ladder end with 4 bolts M 6 x 20 V4A (to be ordered separately)

If the bending radius is higher than 250 mm and if the width of cable ladder is higher than 400 mm, an additional intermediary support is then necessary.

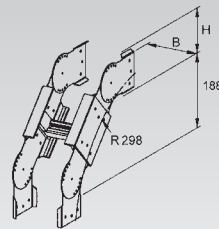

Reducer

pultruded

Item ref.	RAL colour	Height	Width B	EAN code	Weight 100 units pc	Min. pack.
		mm	mm			
E4 K23 ULRU 53.100	7032	53	100	959914	33	1 p.
E4 K23 ULRU 53.150	7032	53	150	959921	37	1 p.
E4 K23 ULRU 53.200	7032	53	200	959938	43	1 p.
E4 K23 ULRU 53.300	7032	53	300	959945	50	1 p.
E4 K23 ULRU 53.400	7032	53	400	959952	64	1 p.

to reduce or increase the cables ladder width

The fittings are delivered with non-perforated rungs. However the option with perforated rungs is still possible, please ask us.

The siderails are made in pultruded GRP. The splices plates are available in GRP, or in stainless steel, please specify the material when ordering.

The dimensions B1 and B2 allow to define the reduction size to use

When mounting, the reducer must be supported by a bracket. The dimension B corresponds to the reduction.

To ensure a correct installation, the stainless steel splice plates must be fixed on each cable ladder end with 8 bolts M6x16V4A and the GRP splice plates must be fixed with 8 bolts M6x20V4A (must be ordered separately)

The splice plates ULGH 53/ ULIH 53 V4A are not included in the cables ladders, please order them separately.

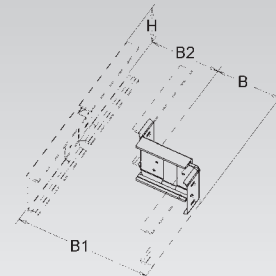

GRP vertical adjustable or vertical fixed angle splice plate

pressed, vertical

Item ref.	RAL colour	Height mm	EAN code	Weight 100 units	Min. pack.
K23 ULGV 53	7032	45	960231	27,5	1 set

for connecting cable ladders and fittings H80, with adjustable or fixed splice plates

Need: 2 pieces for each cut, to be ordered separately

To ensure a correct installation, the stainless steel splice plates must be fixed on each cable ladder end with 8 bolts M6x16V4A and the GRP splice plates must be fixed with 8 bolts M6x20V4A (must be ordered separately)

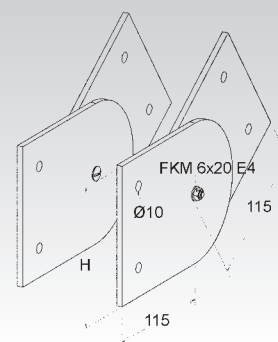

Vertical splice plate

vertical, stainless steel

Item ref.	Height mm	EAN code	Weight 100 units	Min. pack.
E4 ULIV 53 E4	45	960279	30	1 set

for connecting cable ladders and fittings H53, with adjustable splice plates

Need: 2 pieces for each cut, to be ordered separately

To ensure a correct installation, the stainless steel splice plates must be fixed on each cable ladder end with 8 bolts M6x16V4A and the GRP splice plates must be fixed with 8 bolts M6x20V4A (must be ordered separately)

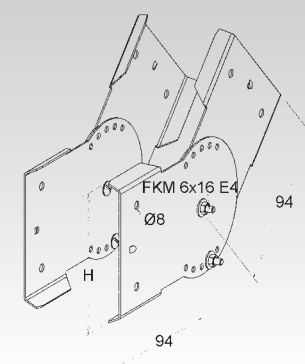

CABLE LADDER SYSTEM UL

GRP cable ladders

pultruded, not perforated rungs

Item ref.	RAL colour	Height	Width B	Material thickness (th)	EAN code	Weight 100 units m	Min. pack.	
		mm	mm	mm				
K23	UL 80.150/3	7032	80	150	4	958078	223	3 m
K23	UL 80.200/3	7032	80	200	4	958092	230	3 m
K23	UL 80.300/3	7032	80	300	4	958115	245	3 m
K23	UL 80.400/3	7032	80	400	4	958139	260	3 m
K23	UL 80.500/3	7032	80	500	4	958153	275	3 m
K23	UL 80.600/3	7032	80	600	4	958177	290	3 m
K23	UL 80.150	7032	80	150	4	958061	223	6 m
K23	UL 80.200	7032	80	200	4	958085	230	6 m
K23	UL 80.300	7032	80	300	4	958108	245	6 m
K23	UL 80.400	7032	80	400	4	958122	260	6 m
K23	UL 80.500	7032	80	500	4	958146	275	6 m
K23	UL 80.600	7032	80	600	4	958160	290	6 m

The cables ladders have the advantage to be 100% GRP (Glass Reinforced Polyester), thanks to unique patented clip-in rungs assembly, without metallic or thermoplastic parts. The cables ladders are delivered with non perforated rungs. However the option of perforated rungs is still possible, please contact us.

Load diagram : q = load evenly distributed cables (according to DIN EN IEC 61537 standard)

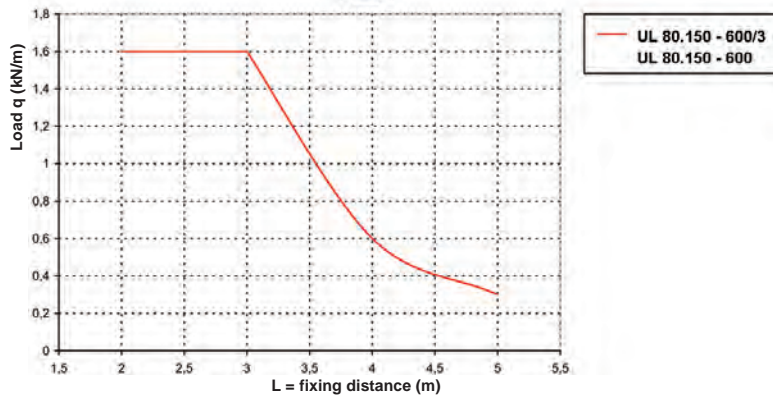
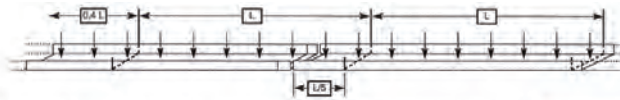

Warning : the deflection is measured with a junction position between 2 cable trays at a distance L/5 from the support. If this distance is not respected, it is necessary to raise the deflection values by approx. 30%.

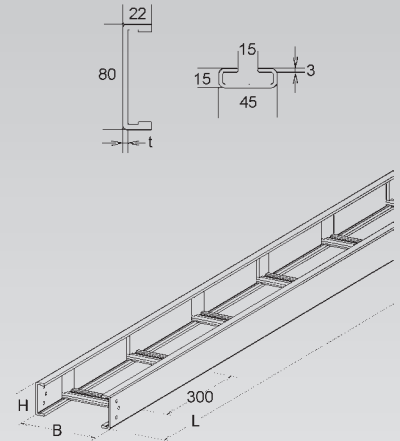

End cap for GRP cable ladder

pultruded

Item ref.	RAL colour	Height	Width B	EAN code	Weight 100 units pc	Min. pack.	
		mm	mm				
K23	ULKE 80.150	7032	80	150	965809	8,5	1 p.
K23	ULKE 80.200	7032	80	200	965816	10,6	1 p.
K23	ULKE 80.300	7032	80	300	965823	14,8	1 p.
K23	ULKE 80.400	7032	80	400	965830	19,1	1 p.
K23	ULKE 80.500	7032	80	500	965847	23,3	1 p.
K23	ULKE 80.600	7032	80	600	965854	27,6	1 p.

Used for: Cable ladders UL...H80 L3 and UL...H80 L6

Mounting accessories required : 2 bolts M6x16 V4A (to be ordered separately)

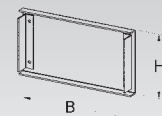

GRP horizontal splice plate

pressed, horizontal

Item ref.	RAL colour	Height	Length L	EAN code	Weight 100 units	Min. pack.	
		mm	mm				
K23	ULGH 80	7032	72	200	960163	10	1 set

for connecting cable ladders and fittings H..., with splice plates

When fixing the splice plates ULIH... and ULGH..., an expansion distance of about 3 mm must be considered.

To ensure a correct installation, the stainless steel splice plates must be fixed on each cable ladder end with 8 bolts M6x16V4A and the GRP splice plates must be fixed with 8 bolts M6x20V4A (must be ordered separately)

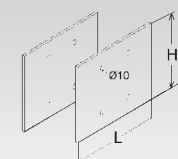

Horizontal stainless steel splice plate

horizontal

Item ref.	Height mm	For oblong perforations LL mm	perforation mm	EAN code	Weight 100 units	Min. pack.
E4 ULIH 80 E4	72	20x8	Ø 8	960200	6,1	1 set

for horizontal changes of directions and for the connection of cable ladders and fittings H80 mount cable ladders with a space of 3 mm minimum

The holes in the splice plates ensure a solid fixing and allow the GRP material expansion.

During the assembly, please verify that the splice plates oblong holes are located on the same side as the supporting bracket. To help fixing the stainless steel splice plates ULIH, we recommend to use a fork-type self locking plier ULP.

To ensure a correct installation, the stainless steel splice plates must be fixed on each cable ladder end with 8 bolts M6x16V4A and the GRP splice plates must be fixed with 8 bolts M6x20V4A (must be ordered separately)

80

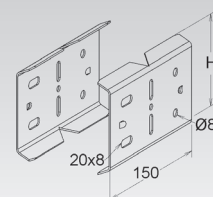

GRP separator

pressed

Item ref.	RAL colour	Height mm	EAN code	Weight 100 units m	Min. pack.
K23 ULTL 80	7032	57	958528	60	3 m

to separate cables with different functions and / or to separate voltages

The GRP cover is fixed with self-tapping screws which are screwed in the ladder siderails and on the cover return flange or with rivets through the ladder siderails.

80

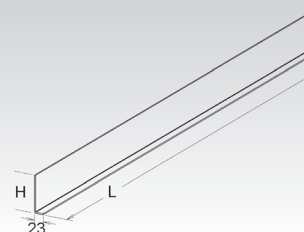

GRP tee junction for cable ladder

pultruded, not perforated rungs

Item ref.	RAL colour	Height mm	Width B mm	EAN code	Weight 100 units pc	Min. pack.
E4 K23 ULTE 80.150	7032	80	150	959297	550	1 p.
E4 K23 ULTE 80.200	7032	80	200	959303	590	1 p.
E4 K23 ULTE 80.300	7032	80	300	959310	653	1 p.
E4 K23 ULTE 80.400	7032	80	400	959327	720	1 p.
E4 K23 ULTE 80.500	7032	80	500	959334	780	1 p.
E4 K23 ULTE 80.600	7032	80	600	959341	850	1 p.

The fittings are delivered with non-perforated rungs. However the option with perforated rungs is still possible, please ask us.

The siderails are made in pultruded GRP. The splices plates are available in GRP, or in stainless steel, please specify the material when ordering.

During assembly, all the fittings must be supported at every cables entry, add a centrale support for all fittings with radius greater than 250 mm, and/or with width greater than 400 mm

To ensure a correct installation, the stainless steel splice plates must be fixed on each cable ladder end with 8 bolts M6x16V4A and the GRP splice plates must be fixed with 8 bolts M6x20V4A (must be ordered separately)

The splice plates ULGH 80/ ULIH 80 V4A are not included in the cables ladders, please order them separately.

80

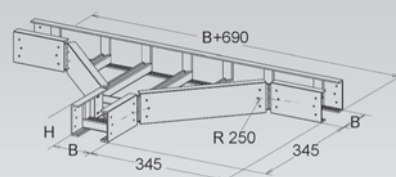

GRP cross for cable ladder

pultruded, not perforated rungs

Item ref.	RAL colour	Height mm	Width B mm	EAN code	Weight 100 units pc	Min. pack.
E4 K23 ULX 80.150	7032	80	150	959631	687,5	1 p.
E4 K23 ULX 80.200	7032	80	200	959648	738,0	1 p.
E4 K23 ULX 80.300	7032	80	300	959655	816,0	1 p.
E4 K23 ULX 80.400	7032	80	400	959662	900,0	1 p.
E4 K23 ULX 80.500	7032	80	500	959679	975,0	1 p.
E4 K23 ULX 80.600	7032	80	600	959686	820,0	1 p.

The fittings are delivered with non-perforated rungs. However the option with perforated rungs is still possible, please ask us.

The siderails are made in pultruded GRP. The splices plates are available in GRP, or in stainless steel, please specify the material when ordering.

During assembly, all the fittings must be supported at every cables entry, add a centrale support for all fittings with radius greater than 250 mm, and/or with width greater than 400 mm

The splice plates ULGH 80/ ULIH 80 V4A are not included in the cables ladders, please order them separately.

80

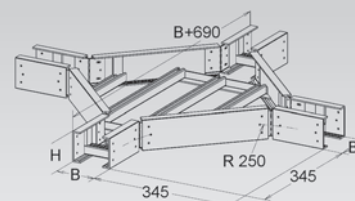

CABLE LADDER SYSTEM UL

GRP elbow 90°

pultruded, not perforated rungs

	Item ref.	RAL colour	Height	Width B	EAN code	Weight 100 units pc	Min. pack.	
			mm	mm				
E4	K23	ULB 80.150	7032	80	150	958610	220	1 p.
E4	K23	ULB 80.200	7032	80	200	958627	240	1 p.
E4	K23	ULB 80.300	7032	80	300	958634	270	1 p.
E4	K23	ULB 80.400	7032	80	400	958641	360	1 p.
E4	K23	ULB 80.500	7032	80	500	958658	400	1 p.
E4	K23	ULB 80.600	7032	80	600	958665	440	1 p.

The fittings are delivered with non-perforated rungs. However the option with perforated rungs is still possible, please ask us.

The siderails are made in pultruded GRP. The splices plates are available in GRP, or in stainless steel, please specify the material when ordering.

During assembly, all the fittings must be supported at every cables entry, add a centrale support for all fittings with radius greater than 250 mm, and/or with width greater than 400 mm

To ensure a correct installation, the stainless steel splice plates must be fixed on each cable ladder end with 8 bolts M6x16V4A and the GRP splice plates must be fixed with 8 bolts M6x20V4A (must be ordered separately)

The splice plates ULGH 80/ ULIH 80 V4A are not included in the cables ladders, please order them separately.

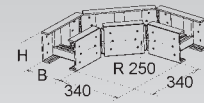

GRP adjustable elbow

pultruded, with integrated splice plates, not perforated rungs

	Item ref.	RAL colour	Height	Width B	EAN code	Weight 100 units pc	Min. pack.	
			mm	mm				
E4	K23	ULBA 80.150	7032	80	150	958955	130	1 p.
E4	K23	ULBA 80.200	7032	80	200	958962	136	1 p.
E4	K23	ULBA 80.300	7032	80	300	958979	144	1 p.
E4	K23	ULBA 80.400	7032	80	400	958986	150	1 p.
E4	K23	ULBA 80.500	7032	80	500	958993	155	1 p.
E4	K23	ULBA 80.600	7032	80	600	959006	161	1 p.

The fittings are delivered with non-perforated rungs. However the option with perforated rungs is still possible, please ask us.

The siderails are made in pultruded GRP. The splices plates are available in GRP, or in stainless steel, please specify the material when ordering.

During assembly, all the fittings must be supported at every cables entry, add a centrale support for all fittings with radius greater than 250 mm, and/or with width greater than 400 mm

To ensure a correct installation, the stainless steel splice plates must be fixed on each cable ladder end with 8 bolts M6x16V4A and the GRP splice plates must be fixed with 8 bolts M6x20V4A (must be ordered separately)

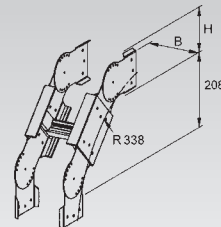

Reducer

pultruded

	Item ref.	RAL colour	Height	Width B	EAN code	Weight 100 units pc	Min. pack.	
			mm	mm				
E4	K23	ULRU 80.100	7032	80	100	959969	42	1 p.
E4	K23	ULRU 80.150	7032	80	150	959976	46	1 p.
E4	K23	ULRU 80.200	7032	80	200	959983	51	1 p.
E4	K23	ULRU 80.300	7032	80	300	959990	63	1 p.
E4	K23	ULRU 80.400	7032	80	400	960002	71	1 p.

to reduce or increase the cables ladder width

The fittings are delivered with non-perforated rungs. However the option with perforated rungs is still possible, please ask us.

The siderails are made in pultruded GRP. The splices plates are available in GRP, or in stainless steel, please specify the material when ordering.

The dimensions B1 and B2 allow to define the reduction size to use

When mounting, the reducer must be supported by a bracket. The dimension B corresponds to the reduction.

To ensure a correct installation, the stainless steel splice plates must be fixed on each cable ladder end with 8 bolts M6x16V4A and the GRP splice plates must be fixed with 8 bolts M6x20V4A (must be ordered separately)

The splice plates ULGH 80/ ULIH 80 V4A are not included in the cables ladders, please order them separately.

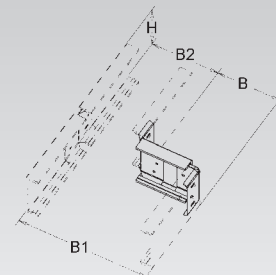

GRP vertical adjustable or vertical fixed angle splice plate

pressed, vertical

Item ref.	RAL colour	Height mm	EAN code	Weight 100 units	Min. pack.
K23 ULGV 80	7032	72	960248	27,5	1 set

for connecting cable ladders and fittings H80, with adjustable or fixed splice plates

Need: 2 pieces for each cut, to be ordered separately

To ensure a correct installation, the stainless steel splice plates must be fixed on each cable ladder end with 8 bolts M6x16V4A and the GRP splice plates must be fixed with 8 bolts M6x20V4A (must be ordered separately)

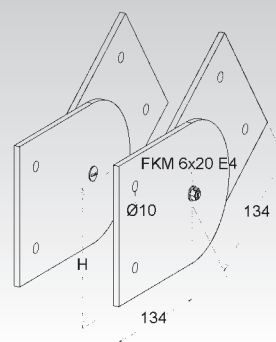

Vertical splice plate

vertical, stainless steel

Item ref.	Height mm	EAN code	Weight 100 units	Min. pack.
E4 ULIV 80 E4	72	960286	30	1 set

for connecting cable ladders and fittings H80, with adjustable splice plates

Need: 2 pieces for each cut, to be ordered separately

To ensure a correct installation, the stainless steel splice plates must be fixed on each cable ladder end with 8 bolts M6x16V4A and the GRP splice plates must be fixed with 8 bolts M6x20V4A (must be ordered separately)

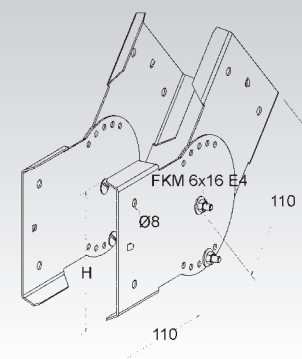

CABLE LADDER SYSTEM UL

GRP cable ladders

pultruded, not perforated rungs

Item ref.	RAL colour	Height mm	Width B mm	Material thickness (th) mm	EAN code	Weight 100 units m	Min. pack.
K23 UL 100.150/3	7032	100	150	5	958191	312,3	3 m
K23 UL 100.200/3	7032	100	200	5	958214	320,8	3 m
K23 UL 100.300/3	7032	100	300	5	958238	338,6	3 m
K23 UL 100.400/3	7032	100	400	5	958252	356,3	3 m
K23 UL 100.450/3	7032	100	450	5	958276	362,0	3 m
K23 UL 100.500/3	7032	100	500	5	958290	375,0	3 m
K23 UL 100.600/3	7032	100	600	5	958313	392,5	3 m
K23 UL 100.750/3	7032	100	750	5	958351	413,5	3 m
K23 UL 100.900/3	7032	100	900	5	958399	445,1	3 m
K23 UL 100.150	7032	100	150	5	958184	312,3	6 m
K23 UL 100.200	7032	100	200	5	958207	320,8	6 m
K23 UL 100.300	7032	100	300	5	958221	338,6	6 m
K23 UL 100.400	7032	100	400	5	958245	356,3	6 m
K23 UL 100.450	7032	100	450	5	958269	362,0	6 m
K23 UL 100.500	7032	100	500	5	958283	375,0	6 m
K23 UL 100.600	7032	100	600	5	958306	392,5	6 m
K23 UL 100.750	7032	100	750	5	958344	413,5	6 m
K23 UL 100.900	7032	100	900	5	958382	445,1	6 m

The cables ladders have the advantage to be 100% GRP (Glass Reinforced Polyester), thanks to unique patented clip-in rungs assembly, without metallic or thermoplastic parts. The cables ladders are delivered with non perforated rungs. However the option of perforated rungs is still possible, please contact us.

Load diagram : q = load evenly distributed cables (according to DIN EN IEC 61537 standard)

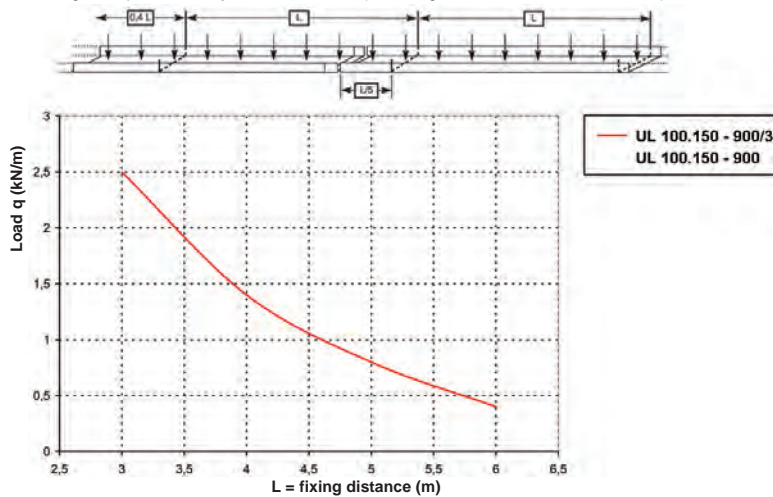

Warning : the deflection is measured with a junction position between 2 cable trays at a distance $L/5$ from the support. If this distance is not respected, it is necessary to raise the deflection values by approx. 30%.

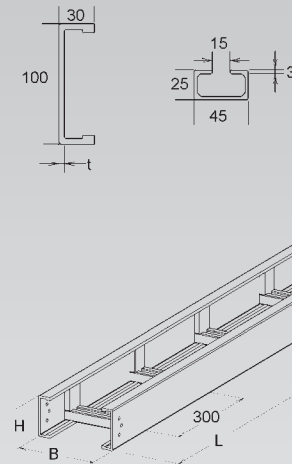

End cap for GRP cable ladder

pultruded

Item ref.	RAL colour	Height mm	Width B mm	EAN code	Weight 100 units pc	Min. pack.
K23 ULKE 100.150	7032	100	150	965526	16	1 p.
K23 ULKE 100.200	7032	100	200	965533	20	1 p.
K23 ULKE 100.300	7032	100	300	965540	27	1 p.
K23 ULKE 100.400	7032	100	400	965557	35	1 p.
K23 ULKE 100.450	7032	100	450	965564	42	1 p.
K23 ULKE 100.500	7032	100	500	965571	45	1 p.
K23 ULKE 100.600	7032	100	600	965588	49	1 p.
K23 ULKE 100.700	7032	100	700	965595	57	1 p.
K23 ULKE 100.750	7032	100	750	965601	60	1 p.
K23 ULKE 100.800	7032	100	800	965618	64	1 p.
K23 ULKE 100.900	7032	100	900	965625	70	1 p.

Used for: Cable ladders UL...H100 L3 and UL...H100 L6

Mounting accessories required : 2 bolts M6x16 V4A (to be ordered separately)

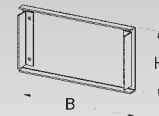

GRP horizontal splice plate

pressed, horizontal

Item ref.	RAL colour	Height	Length L	EAN code	Weight 100 units	Min. pack.
		mm	mm			
K23 ULGH 100	7032	90	200	960170	3,5	1 set

for connecting cable ladders and fittings H..., with splice plates

When fixing the splice plates ULIH... and ULGH..., an expansion distance of about 3 mm must be considered.

To ensure a correct installation, the stainless steel splice plates must be fixed on each cable ladder end with 8 bolts M6x16V4A and the GRP splice plates must be fixed with 8 bolts M6x20V4A (must be ordered separately)

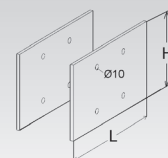

Horizontal stainless steel splice plate

horizontal

Item ref.	Height	perforation	For oblong perforations LL	EAN code	Weight 100 units	Min. pack.
	mm	mm	mm			
E4 ULIH 100 E4	90	Ø 8	20x8	960217	19,5	1 set

for horizontal changes of directions and for the connection of cable ladders and fittings H100

mount cable ladders with a space of 3 mm minimum

The holes in the splice plates ensure a solid fixing and allow the GRP material expansion. During the assembly, please verify that the splice plates oblong holes are located on the same side as the supporting bracket. To help fixing the stainless steel splice plates ULIH, we recommend to use a fork-type self locking plier ULP.

To ensure a correct installation, the stainless steel splice plates must be fixed on each cable ladder end with 8 bolts M6x16V4A and the GRP splice plates must be fixed with 8 bolts M6x20V4A (must be ordered separately)

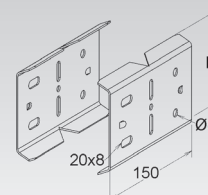

GRP separator

pressed

Item ref.	RAL colour	Height	EAN code	Weight 100 units pc	Min. pack.
		mm			
K23 ULTL 100	7032	65	958535	40	3 m

to separate cables with different functions and / or to separate voltages

The GRP cover is fixed with self-tapping screws which are screwed in the ladder siderails and on the cover return flange or with rivets through the ladder siderails.

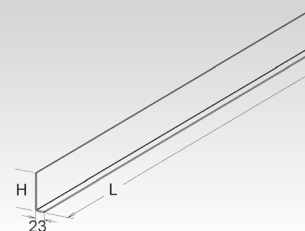

GRP tee junction for cable ladder

pultruded, not perforated rungs

Item ref.	RAL colour	Height	Width B	EAN code	Weight 100 units pc	Min. pack.
		mm	mm			
E4 K23 ULTE 100.150	7032	100	150	959358	520	1 p.
E4 K23 ULTE 100.200	7032	100	200	959365	550	1 p.
E4 K23 ULTE 100.300	7032	100	300	959372	653	1 p.
E4 K23 ULTE 100.400	7032	100	400	959389	720	1 p.
E4 K23 ULTE 100.450	7032	100	450	959396	750	1 p.
E4 K23 ULTE 100.500	7032	100	500	959402	780	1 p.
E4 K23 ULTE 100.600	7032	100	600	959419	850	1 p.
E4 K23 ULTE 100.750	7032	100	750	959433	950	1 p.
E4 K23 ULTE 100.900	7032	100	900	959457	1050	1 p.

The fittings are delivered with non-perforated rungs. However the option with perforated rungs is still possible, please ask us.

The siderails are made in pultruded GRP. The splices plates are available in GRP, or in stainless steel, please specify the material when ordering.

During assembly, all the fittings must be supported at every cables entry, add a centrale support for all fittings with radius greater than 250 mm, and/or with width greater than 400 mm

To ensure a correct installation, the stainless steel splice plates must be fixed on each cable ladder end with 8 bolts M6x16V4A and the GRP splice plates must be fixed with 8 bolts M6x20V4A (must be ordered separately)

Available in radius 250 mm, 600 mm und 900 mm

The splice plates ULGH 100/ ULIH 100 V4A are not included in the cables ladders, please order them separately.

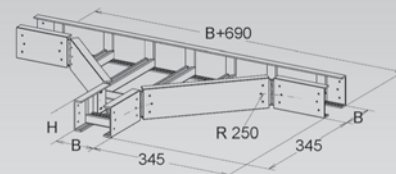

CABLE LADDER SYSTEM UL

GRP cross for cable ladder

pultruded, not perforated rungs

Item ref.	RAL colour	Height	Width B	EAN code	Weight 100 units pc	Min. pack.
		mm	mm			
E4 K23 ULX 100.150	7032	100	150	959693	710	1 p.
E4 K23 ULX 100.200	7032	100	200	959709	750	1 p.
E4 K23 ULX 100.300	7032	100	300	959716	816	1 p.
E4 K23 ULX 100.400	7032	100	400	959723	900	1 p.
E4 K23 ULX 100.450	7032	100	450	959730	940	1 p.
E4 K23 ULX 100.500	7032	100	500	959747	975	1 p.
E4 K23 ULX 100.600	7032	100	600	959754	1070	1 p.
E4 K23 ULX 100.750	7032	100	750	959778	1180	1 p.
E4 K23 ULX 100.900	7032	100	900	959792	1300	1 p.

The fittings are delivered with non-perforated rungs. However the option with perforated rungs is still possible, please ask us.

The siderails are made in pultruded GRP. The splices plates are available in GRP, or in stainless steel, please specify the material when ordering.

During assembly, all the fittings must be supported at every cables entry, add a centrale support for all fittings with radius greater than 250 mm, and/or with width greater than 400 mm

To ensure a correct installation, the stainless steel splice plates must be fixed on each cable ladder end with 8 bolts M6x16V4A and the GRP splice plates must be fixed with 8 bolts M6x20V4A (must be ordered separately)

Available in radius 250 mm, 600 mm und 900 mm

The splice plates ULGH 100/ ULIH 100 V4A are not included in the cables ladders, please order them separately.

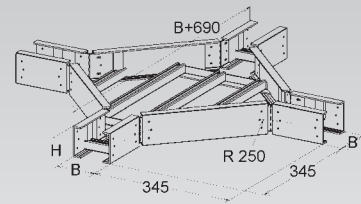

GRP elbow 90°

pultruded, not perforated rungs

Item ref.	RAL colour	Height	Width B	EAN code	Weight 100 units pc/m	Min. pack.
		mm	mm			
E4 K23 ULB 100.150	7032	100	150	958672	320	1 p.
E4 K23 ULB 100.200	7032	100	200	958689	340	1 p.
E4 K23 ULB 100.300	7032	100	300	958696	388	1 p.
E4 K23 ULB 100.400	7032	100	400	958702	470	1 p.
E4 K23 ULB 100.450	7032	100	450	958719	490	1 p.
E4 K23 ULB 100.500	7032	100	500	958726	520	1 p.
E4 K23 ULB 100.600	7032	100	600	958733	570	1 p.
E4 K23 ULB 100.750	7032	100	750	958757	648	1 p.
E4 K23 ULB 100.900	7032	100	900	958771	720	1 p.

The fittings are delivered with non-perforated rungs. However the option with perforated rungs is still possible, please ask us.

The siderails are made in pultruded GRP. The splices plates are available in GRP, or in stainless steel, please specify the material when ordering.

During assembly, all the fittings must be supported at every cables entry, add a centrale support for all fittings with radius greater than 250 mm, and/or with width greater than 400 mm

To ensure a correct installation, the stainless steel splice plates must be fixed on each cable ladder end with 8 bolts M6x16V4A and the GRP splice plates must be fixed with 8 bolts M6x20V4A (must be ordered separately)

Available in radius 250 mm, 600 mm und 900 mm

The splice plates ULGH 100/ ULIH 100 V4A are not included in the cables ladders, please order them separately.

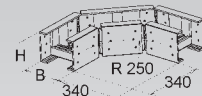

GRP adjustable elbow

pultruded, with integrated splice plates, not perforated rungs

Item ref.	RAL colour	Height	Width B	EAN code	Weight 100 units pc	Min. pack.
		mm	mm			
E4 K23 ULBA 100.150	7032	100	150	959013	220	1 p.
E4 K23 ULBA 100.200	7032	100	200	959020	212	1 p.
E4 K23 ULBA 100.300	7032	100	300	959037	217	1 p.
E4 K23 ULBA 100.400	7032	100	400	959044	223	1 p.
E4 K23 ULBA 100.450	7032	100	450	959051	226	1 p.
E4 K23 ULBA 100.500	7032	100	500	959068	228	1 p.
E4 K23 ULBA 100.600	7032	100	600	959075	234	1 p.
E4 K23 ULBA 100.750	7032	100	750	959099	242	1 p.
E4 K23 ULBA 100.900	7032	100	900	959112	251	1 p.

The fittings are delivered with non-perforated rungs. However the option with perforated rungs is still possible, please ask us.

The siderails are made in pultruded GRP. The splices plates are available in GRP, or in stainless steel, please specify the material when ordering.

During assembly, all the fittings must be supported at every cables entry, add a centrale support for all fittings with radius greater than 250 mm, and/or with width greater than 400 mm

To ensure a correct installation, the stainless steel splice plates must be fixed on each cable ladder end with 8 bolts M6x16V4A and the GRP splice plates must be fixed with 8 bolts M6x20V4A (must be ordered separately)

Available in radius around 600 mm & 900 mm.

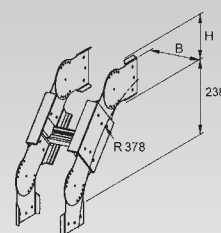

Reducer

pultruded

Item ref.	RAL colour	Height	Width B	EAN code	Weight 100 units pc	Min. pack.
		mm	mm			
E4 K23 ULRU 100.100	7032	100	100	960019	51	1 p.
E4 K23 ULRU 100.150	7032	100	150	960026	55	1 p.
E4 K23 ULRU 100.200	7032	100	200	960033	65	1 p.
E4 K23 ULRU 100.300	7032	100	300	960040	78	1 p.
E4 K23 ULRU 100.400	7032	100	400	960057	95	1 p.
E4 K23 ULRU 100.500	7032	100	500	960064	109	1 p.
E4 K23 ULRU 100.600	7032	100	600	960071	117	1 p.

to reduce or increase the cables ladder width

The fittings are delivered with non-perforated rungs. However the option with perforated rungs is still possible, please ask us.

The siderails are made in pultruded GRP. The splices plates are available in GRP, or in stainless steel, please specify the material when ordering.

The dimensions B1 and B2 allow to define the reduction size to use

When mounting, the reducer must be supported by a bracket. The dimension B corresponds to the reduction.

To ensure a correct installation, the stainless steel splice plates must be fixed on each cable ladder end with 8 bolts M6x16V4A and the GRP splice plates must be fixed with 8 bolts M6x20V4A (must be ordered separately)

The splice plates ULGH 100/ ULIH 100 V4A are not included in the cables ladders, please order them separately.

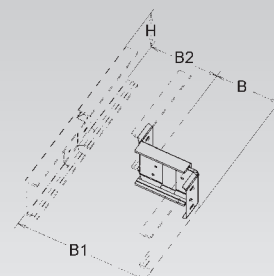

GRP vertical adjustable or with fixed angle splice plate

pressed, vertical

Item ref.	RAL colour	Height	EAN code	Weight 100 units	Min. pack.
		mm			
K23 ULGV 100	7032	100	960255	27,5	1 set

for connecting cable ladders and fittings H80, with adjustable or fixed splice plates

Need: 2 pieces for each cut, to be ordered separately

To ensure a correct installation, the stainless steel splice plates must be fixed on each cable ladder end with 8 bolts M6x16V4A and the GRP splice plates must be fixed with 8 bolts M6x20V4A (must be ordered separately)

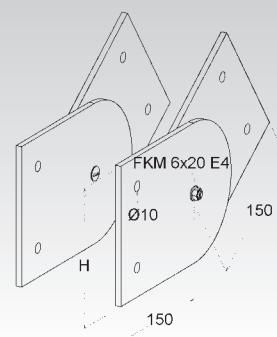

CABLE LADDER SYSTEM UL

Vertical splice plate

Stainless steel, vertical

Item ref.	Height mm	EAN code	Weight 100 units	Min. pack.
E5 ULIV 100 E4	90	960293	30	1 set

for connecting cable ladders and fittings H100, with adjustable splice plates

Need: 2 pieces for each cut, to be ordered separatly

To ensure a correct installation, the stainless steel splice plates must be fixed on each cable ladder end with 8 bolts M6x16V4A and the GRP splice plates must be fixed with 8 bolts M6x20V4A (must be ordered separately)

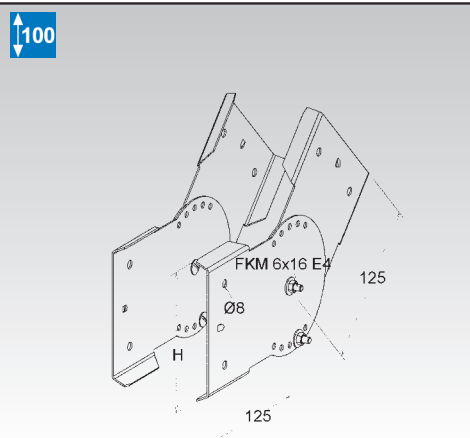

GRP cable ladders

pultruded

Item ref.	RAL colour	Height mm	Width B mm	Material thickness (th) mm	EAN code	Weight 100 units m	Min. pack.
K23 UL 150.150/3	7032	150	150	6	965168	553,5	3 m
K23 UL 150.200/3	7032	150	200	6	965175	570,3	3 m
K23 UL 150.300/3	7032	150	300	6	965182	603,3	3 m
K23 UL 150.400/3	7032	150	400	6	965199	636,8	3 m
K23 UL 150.450/3	7032	150	450	6	965205	653,6	3 m
K23 UL 150.500/3	7032	150	500	6	965212	670,3	3 m
K23 UL 150.600/3	7032	150	600	6	965229	660,0	3 m
K23 UL 150.750/3	7032	150	750	6	965243	754,1	3 m
K23 UL 150.900/3	7032	150	900	6	965267	804,3	3 m
K23 UL 150.150	7032	150	150	6	958405	553,5	6 m
K23 UL 150.200	7032	150	200	6	958412	570,3	6 m
K23 UL 150.300	7032	150	300	6	958429	603,3	6 m
K23 UL 150.400	7032	150	400	6	958436	636,8	6 m
K23 UL 150.450	7032	150	450	6	958443	653,6	6 m
K23 UL 150.500	7032	150	500	6	958450	670,3	6 m
K23 UL 150.600	7032	150	600	6	958467	660,0	6 m
K23 UL 150.750	7032	150	750	6	958481	754,1	6 m
K23 UL 150.900	7032	150	900	6	958504	804,3	6 m

The cables ladders have the advantage to be 100% GRP (Glass Reinforced Polyester), thanks to unique patented clip-in rungs assembly, without metallic or thermoplastic parts. The cables ladders are delivered with non perforated rungs. However the option of perforated rungs is still possible, please contact us.

Load diagram : q = load evenly distributed cables (according to DIN EN IEC 61537 standard)

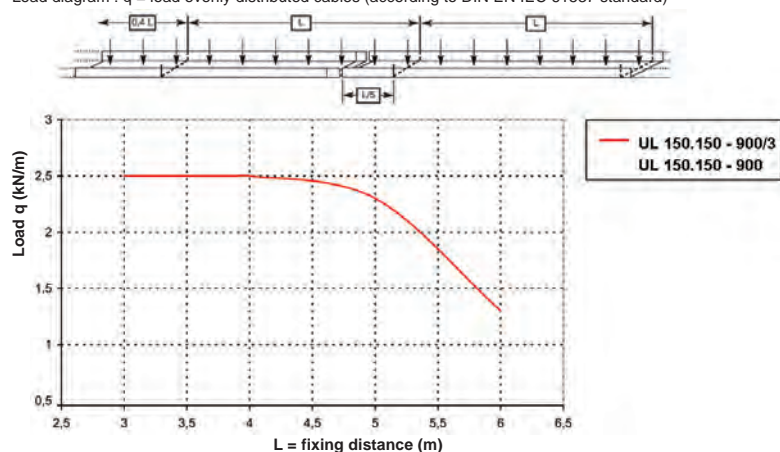

Warning : the deflection is measured with a junction position between 2 cable trays at a distance $L/5$ from the support. If this distance is not respected, it is necessary to raise the deflection values by approx. 30%.

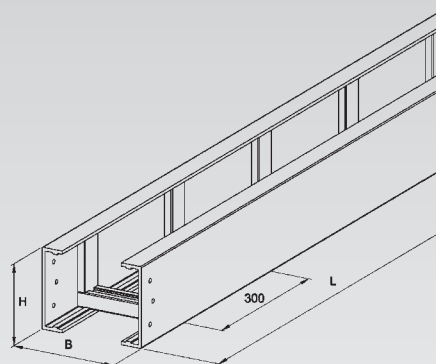
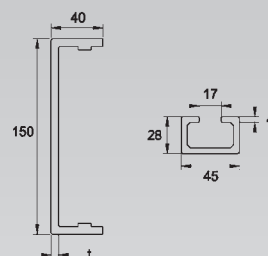

End cap for GRP cable ladder

pultruded

Item ref.	RAL colour	Height mm	Width B mm	EAN code	Weight 100 units pc	Min. pack.
K23 ULKE 150.150	7032	150	150	965632	16,4	1 p.
K23 ULKE 150.200	7032	150	200	965649	20,4	1 p.
K23 ULKE 150.300	7032	150	300	965656	28,4	1 p.
K23 ULKE 150.400	7032	150	400	965663	36,3	1 p.
K23 ULKE 150.450	7032	150	450	965670	40,3	1 p.
K23 ULKE 150.500	7032	150	500	965687	44,3	1 p.
K23 ULKE 150.600	7032	150	600	965694	52,2	1 p.
K23 ULKE 150.750	7032	150	750	965717	64,2	1 p.
K23 ULKE 150.900	7032	150	900	965731	76,1	1 p.

Used for: Cable ladders UL...H150 L3 and UL...H150 L6

Mounting accessories required : 2 bolts M6x16 V4A (to be ordered separately)

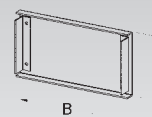

CABLE LADDER SYSTEM UL

GRP horizontal splice plate

pressed, horizontal

Item ref.	RAL colour	Height	Length L	EAN code	Weight 100 units pc	Min. pack.
		mm	mm			
K23 ULGH 150	7032	138	250	960187	38	1 set

for connecting cable ladders and fittings H..., with splice plates

When fixing the splice plates ULIH... and ULGH..., an expansion distance of about 3 mm must be considered.

To ensure a correct installation, the stainless steel splice plates must be fixed on each cable ladder end with 8 bolts M6x16V4A and the GRP splice plates must be fixed with 8 bolts M6x20V4A (must be ordered separately)

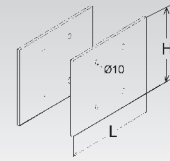

Horizontal stainless steel splice plate

horizontal

Item ref.	Height	perforation	For oblong perforations LL	EAN code	Weight 100 units	Min. pack.
	mm	mm	mm			
E4 ULIH 150 E4	138	Ø 8	20x8	960224	27	1 set

for horizontal changes of directions and for the connection of cable ladders and fittings H150

mount cable ladders with a space of 3 mm minimum

The holes in the splice plates ensure a solid fixing and allow the GRP material expansion. During the assembly, please verify that the splice plates oblong holes are located on the same side as the supporting bracket. To help fixing the stainless steel splice plates ULIH, we recommend to use a fork-type self locking plier ULP.

To ensure a correct installation, the stainless steel splice plates must be fixed on each cable ladder end with 8 bolts M6x16V4A and the GRP splice plates must be fixed with 8 bolts M6x20V4A (must be ordered separately)

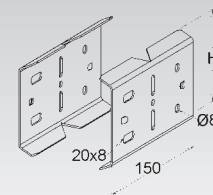

GRP separator

pressed

Item ref.	RAL colour	Height	EAN code	Weight 100 units m	Min. pack.
		mm			
K23 ULTL 150	7032	102	958542	80	3 m

to separate cables with different functions and / or to separate voltages

The GRP cover is fixed with self-tapping screws which are screwed in the ladder siderails and on the cover return flange or with rivets through the ladder siderails.

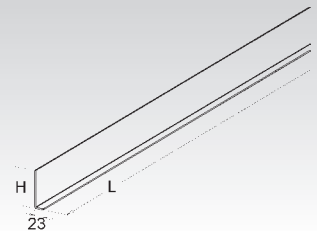

GRP tee junction for cable ladder

pultruded

Item ref.	RAL colour	Height	Width B	EAN code	Weight 100 units pc	Min. pack.
		mm	mm			
E4 K23 ULTE 150.150	7032	150	150	959464	650	1 p.
E4 K23 ULTE 150.200	7032	150	200	959471	800	1 p.
E4 K23 ULTE 150.300	7032	150	300	959488	999	1 p.
E4 K23 ULTE 150.400	7032	150	400	959495	1200	1 p.
E4 K23 ULTE 150.450	7032	150	450	959501	1300	1 p.
E4 K23 ULTE 150.500	7032	150	500	959518	1200	1 p.
E4 K23 ULTE 150.600	7032	150	600	959525	1250	1 p.
E4 K23 ULTE 150.750	7032	150	750	959549	1660	1 p.
E4 K23 ULTE 150.900	7032	150	900	959563	1910	1 p.

The fittings are delivered with non-perforated rungs. However the option with perforated rungs is still possible, please ask us.

The siderails are made in pultruded GRP. The splices plates are available in GRP, or in stainless steel, please specify the material when ordering.

During assembly, all the fittings must be supported at every cables entry, add a centrale support for all fittings with radius greater than 250 mm, and/or with width greater than 400 mm

To ensure a correct installation, the stainless steel splice plates must be fixed on each cable ladder end with 8 bolts M6x16V4A and the GRP splice plates must be fixed with 8 bolts M6x20V4A (must be ordered separately)

Available in radius 250 mm, 600 mm und 900 mm

The splice plates ULGH 150/ ULIH 150 V4A are not included in the cables ladders, please order them separately.

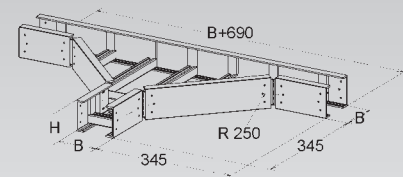

GRP cross for cable ladder

pultruded, not perforated rungs

	Item ref.	RAL colour	Height mm	Width B mm	EAN code	Weight 100 units pc	Min. pack.	
E4	K23	ULX 150.150	7032	150	150	959808	812,5	1 p.
E4	K23	ULX 150.200	7032	150	200	959815	1.000,0	1 p.
E4	K23	ULX 150.300	7032	150	300	959822	1.247,0	1 p.
E4	K23	ULX 150.400	7032	150	400	959839	1.540,0	1 p.
E4	K23	ULX 150.450	7032	150	450	959846	1.650,0	1 p.
E4	K23	ULX 150.500	7032	150	500	959853	1.500,0	1 p.
E4	K23	ULX 150.600	7032	150	600	959860	1.900,0	1 p.
E4	K23	ULX 150.750	7032	150	750	959884	2.110,0	1 p.
E4	K23	ULX 150.900	7032	150	900	959907	2.830,0	1 p.

The fittings are delivered with non-perforated rungs. However the option with perforated rungs is still possible, please ask us.

The siderails are made in pultruded GRP. The splices plates are available in GRP, or in stainless steel, please specify the material when ordering.

During assembly, all the fittings must be supported at every cables entry, add a centrale support for all fittings with radius greater than 250 mm, and/or with width greater than 400 mm

To ensure a correct installation, the stainless steel splice plates must be fixed on each cable ladder end with 8 bolts M6x16V4A and the GRP splice plates must be fixed with 8 bolts M6x20V4A (must be ordered separately)

Available in radius 250 mm, 600 mm und 900 mm

The splice plates ULGH 150/ ULIH 150 V4A are not included in the cables ladders, please order them separately.

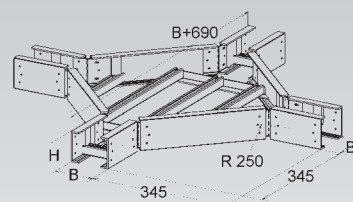

GRP elbow 90°

pultruded, not perforated rungs

	Item ref.	RAL colour	Height mm	Width B mm	EAN code	Weight 100 units pc	Min. pack.	
E4	K23	ULB 150.150	7032	150	150	958788	548,7	1 p.
E4	K23	ULB 150.200	7032	150	200	958795	584,4	1 p.
E4	K23	ULB 150.300	7032	150	300	958801	656,0	1 p.
E4	K23	ULB 150.400	7032	150	400	958818	830,0	1 p.
E4	K23	ULB 150.450	7032	150	450	958825	880,0	1 p.
E4	K23	ULB 150.500	7032	150	500	958832	930,0	1 p.
E4	K23	ULB 150.600	7032	150	600	958849	1.050,0	1 p.
E4	K23	ULB 150.750	7032	150	750	958863	1.068,0	1 p.
E4	K23	ULB 150.900	7032	150	900	958887	1.087,0	1 p.

The fittings are delivered with non-perforated rungs. However the option with perforated rungs is still possible, please ask us.

The siderails are made in pultruded GRP. The splices plates are available in GRP, or in stainless steel, please specify the material when ordering.

During assembly, all the fittings must be supported at every cables entry, add a centrale support for all fittings with radius greater than 250 mm, and/or with width greater than 400 mm

To ensure a correct installation, the stainless steel splice plates must be fixed on each cable ladder end with 8 bolts M6x16V4A and the GRP splice plates must be fixed with 8 bolts M6x20V4A (must be ordered separately)

Available in radius 250 mm, 600 mm und 900 mm

The splice plates ULGH 150/ ULIH 150 V4A are not included in the cables ladders, please order them separately.

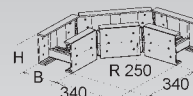

CABLE LADDER SYSTEM UL

GRP adjustable elbow

pultruded, with integrated splice plates, not perforated rungs

Item ref.	RAL colour	Height	Width B	EAN code	Weight 100 units pc	Min. pack.
		mm	mm			
E4 K23 ULBA 150.150	7032	150	150	959129	400	1 p.
E4 K23 ULBA 150.200	7032	150	200	959136	410	1 p.
E4 K23 ULBA 150.300	7032	150	300	959143	420	1 p.
E4 K23 ULBA 150.400	7032	150	400	959150	430	1 p.
E4 K23 ULBA 150.450	7032	150	450	959167	435	1 p.
E4 K23 ULBA 150.500	7032	150	500	959174	440	1 p.
E4 K23 ULBA 150.600	7032	150	600	959181	450	1 p.
E4 K23 ULBA 150.750	7032	150	750	959204	470	1 p.
E4 K23 ULBA 150.900	7032	150	900	959228	480	1 p.

The fittings are delivered with non-perforated rungs. However the option with perforated rungs is still possible, please ask us.

The siderails are made in pultruded GRP. The splices plates are available in GRP, or in stainless steel, please specify the material when ordering.

During assembly, all the fittings must be supported at every cables entry, add a centrale support for all fittings with radius greater than 250 mm, and/or with width greater than 400 mm

To ensure a correct installation, the stainless steel splice plates must be fixed on each cable ladder end with 8 bolts M6x16V4A and the GRP splice plates must be fixed with 8 bolts M6x20V4A (must be ordered separately)

Available in radius around 600 mm & 900 mm.

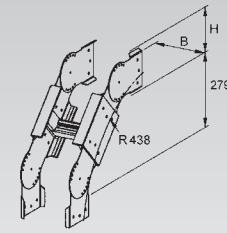

Reducer

pultruded

Item ref.	RAL colour	Height	Width B	EAN code	Weight 100 units pc	Min. pack.
		mm	mm			
E4 K23 ULRU 150.100	7032	150	100	960088	77	1 p.
E4 K23 ULRU 150.150	7032	150	150	960095	102	1 p.
E4 K23 ULRU 150.200	7032	150	200	960101	102	1 p.
E4 K23 ULRU 150.300	7032	150	300	960118	126	1 p.
E4 K23 ULRU 150.400	7032	150	400	960125	153	1 p.
E4 K23 ULRU 150.500	7032	150	500	960132	200	1 p.
E4 K23 ULRU 150.600	7032	150	600	960149	200	1 p.

to reduce or increase the cables ladder width

The fittings are delivered with non-perforated rungs. However the option with perforated rungs is still possible, please ask us.

The siderails are made in pultruded GRP. The splices plates are available in GRP, or in stainless steel, please specify the material when ordering.

The dimensions B1 and B2 allow to define the reduction size to use

When mounting, the reducer must be supported by a bracket. The dimension B corresponds to the reduction.

To ensure a correct installation, the stainless steel splice plates must be fixed on each cable ladder end with 8 bolts M6x16V4A and the GRP splice plates must be fixed with 8 bolts M6x20V4A (must be ordered separately)

The splice plates ULGH 150/ ULIH 150 V4A are not included in the cables ladders, please order them separately.

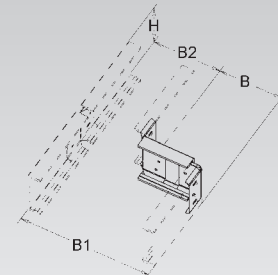

GRP vertical adjustable or vertical fixed angle splice plate

pressed, vertical

Item ref.	RAL colour	Height	EAN code	Weight 100 units	Min. pack.
		mm			
K23 ULGV 150	7032	138	960262	27,5	1 set

for connecting cable ladders and fittings H80, with adjustable or fixed splice plates

Need: 2 pieces for each cut, to be ordered separately

To ensure a correct installation, the stainless steel splice plates must be fixed on each cable ladder end with 8 bolts M6x16V4A and the GRP splice plates must be fixed with 8 bolts M6x20V4A (must be ordered separately)

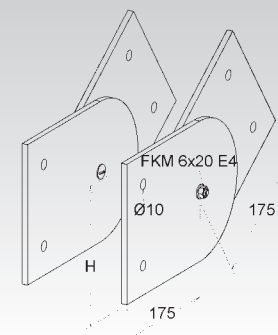

Vertical splice plate

vertical, stainless steel

Item ref.	Height mm	EAN code	Weight 100 units	Min. pack.
E4 ULIV 150 E4	138	960309	30	1 set

for connecting cable ladders and fittings H150, with adjustable splice plates

Need: 2 pieces for each cut, to be ordered separatly

To ensure a correct installation, the stainless steel splice plates must be fixed on each cable ladder end with 8 bolts M6x16V4A and the GRP splice plates must be fixed with 8 bolts M6x20V4A (must be ordered separately)

150

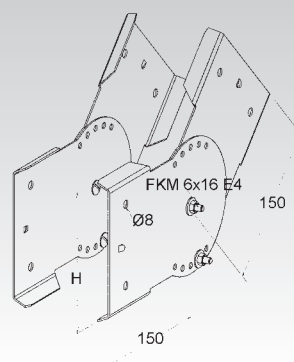

CABLE LADDER SYSTEM COVERS UL

Cover for cable trays and cable ladders

pressed

Item ref.	RAL colour	Width B mm	EAN code	Weight 100 units pc/	Min. pack.
K23 KKD 50	7032	50	956104	47	3 m
K23 KKD 100	7032	100	956111	78	3 m
K23 KKD 150	7032	150	956128	105	3 m
K23 KKD 200	7032	200	956135	132	3 m
K23 KKD 250	7032	250	956142	152	3 m
K23 KKD 300	7032	300	956159	190	3 m
K23 KKD 400	7032	400	956166	243	3 m
K23 KKD 450	7032	450	956173	285	3 m
K23 KKD 500	7032	500	956180	292	3 m
K23 KKD 600	7032	600	956197	338	3 m
K23 KKD 750	7032	750	956210	438	3 m
K23 KKD 900	7032	900	956234	585	1,5 m

For a stronger assembly, the covers with a width above 400 mm are strengthened. These strengthenings / ribs are visible on the outside face of the part.

Used for: Cable tray H50, H80 and H110 mm, KK..., KKL... and cable ladder UL...H53, H80, H100 and H150 mm

For a strong and compliant assembly, we recommend to leave a minimum distance of 8 mm between the covers and the sidewalls of cable trays.

Covers are attached by using stainless steel cover clips DF...V4A, DF M... and DFUB... In extreme weather conditions, strong winds, storms for example, the quantity of clips must be increased.

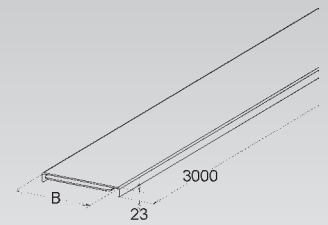

Cover for horizontal elbow 90°

pressed

Item ref.	RAL colour	Width B mm	EAN code	Weight 100 units pc	Min. pack.
K23 ULBD 150	7032	150	957422	115	1 p.
K23 ULBD 200	7032	200	957439	126	1 p.
K23 ULBD 300	7032	300	957446	210	1 p.
K23 ULBD 400	7032	400	957453	270	1 p.
K23 ULBD 450	7032	450	957460	330	1 p.
K23 ULBD 500	7032	500	957477	380	1 p.
K23 ULBD 600	7032	600	957484	490	1 p.
K23 ULBD 750	7032	750	957507	565	1 p.
K23 ULBD 900	7032	900	957521	683	1 p.

For a stronger assembly, the covers with a width above 400 mm are strengthened. These strengthenings / ribs are visible on the outside face of the part.

Used for: Horizontal elbow 90° H53, H80, H100 and H150, ULB...

Covers are attached by using stainless steel cover clips DF...V4A, DF M... and DFUB... In extreme weather conditions, strong winds, storms for example, the quantity of clips must be increased.

Cover for elbow available in radius R250, R600 and R900 mm

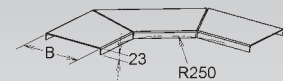

GRP cover for vertical adjustable elbow

Item ref.	RAL colour	Width B mm	EAN code	Weight 100 units	Min. pack.
K23 ULBAD 53.150	7032	150	059188	26,5	1 p.
K23 ULBAD 53.200	7032	200	059195	33,3	1 p.
K23 ULBAD 53.300	7032	300	059218	47,9	1 p.
K23 ULBAD 53.400	7032	400	059225	61,2	1 p.
K23 ULBAD 53.500	7032	500	059232	73,6	1 p.
K23 ULBAD 53.600	7032	600	059249	85,2	1 p.

For a stronger assembly, the covers with a width above 400 mm are strengthened. These strengthenings / ribs are visible on the outside face of the part.

Used for: Vertical elbow 53 mm high, ULBA...

Covers are attached by using stainless steel cover clips DF...V4A, DF M... and DFUB... In extreme weather conditions, strong winds, storms for example, the quantity of clips must be increased.

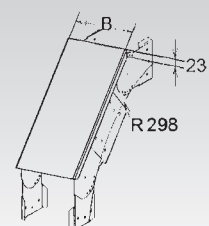

GRP cover for vertical adjustable elbow

pressed

Item ref.	RAL colour	Width B mm	EAN code	Weight 100 units	Min. pack.
K23 ULBAD 80.150	7032	150	059256	29,4	1 p.
K23 ULBAD 80.200	7032	200	059263	37,0	1 p.
K23 ULBAD 80.300	7032	300	059270	53,2	1 p.
K23 ULBAD 80.400	7032	400	059287	68,0	1 p.
K23 ULBAD 80.500	7032	500	059294	81,8	1 p.
K23 ULBAD 80.600	7032	600	059317	94,6	1 p.

For a stronger assembly, the covers with a width above 400 mm are strengthened. These strengthenings / ribs are visible on the outside face of the part.

Used for: Vertical elbow 80 mm high, ULBA...

Covers are attached by using stainless steel cover clips DF...V4A, DF M... and DFUB... In extreme weather conditions, strong winds, storms for example, the quantity of clips must be increased.

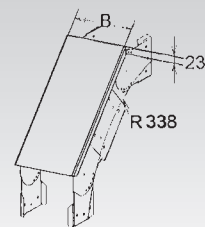

GRP cover for vertical adjustable elbow

pressed

Item ref.	RAL colour	Width B mm	EAN code	Weight 100 units pc	Min. pack.
K23 ULBAD 100.150	7032	150	957538	32,9	1 p.
K23 ULBAD 100.200	7032	200	957545	41,3	1 p.
K23 ULBAD 100.300	7032	300	957552	59,5	1 p.
K23 ULBAD 100.400	7032	400	957569	76,1	1 p.
K23 ULBAD 100.450	7032	450	957576	83,7	1 p.
K23 ULBAD 100.500	7032	500	957583	91,4	1 p.
K23 ULBAD 100.600	7032	600	957590	105,8	1 p.
K23 ULBAD 100.750	7032	750	957613	137,1	1 p.
K23 ULBAD 100.900	7032	900	957637	183,1	1 p.

For a stronger assembly, the covers with a width above 400 mm are strengthened. These strengthenings / ribs are visible on the outside face of the part.

Used for: Vertical elbow H100, ULBA...

Covers are attached by using stainless steel cover clips DF...V4A, DF M... and DFUB... In extreme weather conditions, strong winds, storms for example, the quantity of clips must be increased.

Cover for elbow available in radius R600 & R900 mm

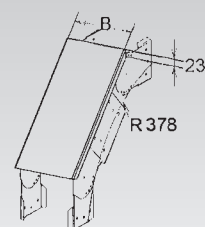

GRP cover for vertical adjustable elbow

pressed

Item ref.	RAL colour	Width B mm	EAN code	Weight 100 units	Min. pack.
K23 ULBAD 150.150	7032	150	059089	38,1	1 p.
K23 ULBAD 150.200	7032	200	059096	47,9	1 p.
K23 ULBAD 150.300	7032	300	059119	69,0	1 p.
K23 ULBAD 150.400	7032	400	059126	88,2	1 p.
K23 ULBAD 150.450	7032	450	059133	97,1	1 p.
K23 ULBAD 150.500	7032	500	059140	106,0	1 p.
K23 ULBAD 150.600	7032	600	059157	122,7	1 p.
K23 ULBAD 150.750	7032	750	059164	159,0	1 p.
K23 ULBAD 150.900	7032	900	059171	212,4	1 p.

For a stronger assembly, the covers with a width above 400 mm are strengthened. These strengthenings / ribs are visible on the outside face of the part.

Used for: Vertical elbow 150 mm high, ULBA...

Covers are attached by using stainless steel cover clips DF...V4A, DF M... and DFUB... In extreme weather conditions, strong winds, storms for example, the quantity of clips must be increased.

Cover for elbow available in radius R600 & R900 mm

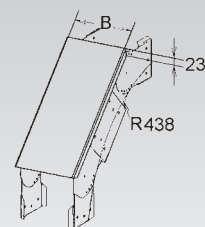

CABLE LADDER SYSTEM COVERS UL

GRP cover for tee junction

pressed

Item ref.	RAL colour	Width B mm	EAN code	Weight 100 units pc	Min. pack.
K23 ULTED 150	7032	150	957644	51	1 p.
K23 ULTED 200	7032	200	957651	55	1 p.
K23 ULTED 300	7032	300	957668	62	1 p.
K23 ULTED 400	7032	400	957675	69	1 p.
K23 ULTED 450	7032	450	957682	74	1 p.
K23 ULTED 500	7032	500	957699	81	1 p.
K23 ULTED 600	7032	600	957705	88	1 p.
K23 ULTED 750	7032	750	957729	105	1 p.
K23 ULTED 900	7032	900	957743	118	1 p.

Used for: T H53, H80, H100 et H150, ULTE...

Covers are attached by using stainless steel cover clips DF...V4A, DF M... and DFUB... In extreme weather conditions, strong winds, storms for example, the quantity of clips must be increased.

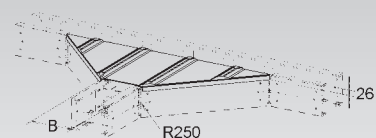

GRP cover for cross

pressed

Item ref.	RAL colour	Width B mm	EAN code	Weight 100 units pc/m	Min. pack.
K23 ULXD 150	7032	150	957750	75	1 p.
K23 ULXD 200	7032	200	957767	80	1 p.
K23 ULXD 300	7032	300	957774	90	1 p.
K23 ULXD 400	7032	400	957781	100	1 p.
K23 ULXD 450	7032	450	957798	105	1 p.
K23 ULXD 500	7032	500	957804	110	1 p.
K23 ULXD 600	7032	600	957811	120	1 p.
K23 ULXD 750	7032	750	957835	135	1 p.
K23 ULXD 900	7032	900	957859	150	1 p.

For a stronger assembly, the covers with a width above 400 mm are strengthened. These strengthenings / ribs are visible on the outside face of the part.

Used for: GRP ladder cross H53, H80, H100 and H150, ULX...

Covers are attached by using stainless steel cover clips DF...V4A, DF M... and DFUB... In extreme weather conditions, strong winds, storms for example, the quantity of clips must be increased.

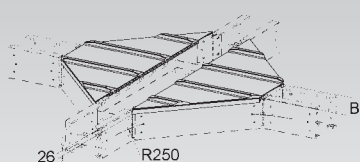

Cover fixing clip

stainless steel

Item ref.	Height mm	EAN code	Weight 100 units pc.	Min. pack.
E4 DF 50 E4	55	957873	1,7	50 p.
E4 DF 80 E4	85	957880	2,1	50 p.
E4 DF 100 E4	110	957897	2,3	50 p.
E4 DF 150 E4	150	957903	3,4	50 p.

for fixing the cables tray covers and fittings

Used for: Cable tray cover KKD... and KPD...

Cover for fittings KKCD..., KKBD..., KKWD..., KKBAD..., KKBID..., KKETD..., KKSTD..., KKSSD..., KKRLD... and KKRRD...

Under normal conditions, it is recommended to mount 1 clip each meter alternatively every 3 meters. Under extreme weather conditions, such as strong winds or storms, the quantity of clips must be increased.



Wall-mounted angle plate

asymmetrical

Item ref.	Material thickness (th) mm	EAN code	Weight 100 units pc	Min. pack.
E4 ULKV E4	5	960330	20	1 p.

for fixing the cables ladders on the floor, or for a ceiling mounting and for a wall mounting.

Mounting accessories required : M10x30 V4A (to be ordered separately)

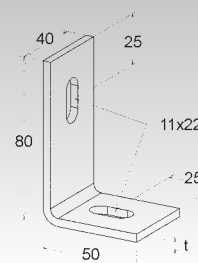

Cover fixing

Item ref.	EAN code	Weight 100 units	Min. pack.
E4 DFUB 5.5X19 E4	062065	0,64	50 p.

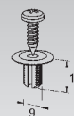

Used for: Cover for cable tray KKD... and KPD...

Cover for fittings KKCD..., KKBD..., KKWD..., KKBAD..., KKBID..., KKETD..., KKSTD..., KKSSD..., KKRLD... und KKRRD...

For fixing the cover, it is necessary to drill a 8,2 mm diameter hole for the diameter. In extreme weather conditions such as strong winds, for example, the quantity of clips must be increased.

Steel tape for cover

Item ref.	RAL colour	Height mm	Width B mm	EAN code	Weight 100 units pc	Min. pack.
E4 K23 DFW 53.150	7032	53	150	968022	31,0	1 p.
E4 K23 DFW 53.200	7032	53	200	968039	36,6	1 p.
E4 K23 DFW 53.300	7032	53	300	968046	47,6	1 p.
E4 K23 DFW 53.400	7032	53	400	968053	58,7	1 p.
E4 K23 DFW 53.500	7032	53	500	968060	69,8	1 p.
E4 K23 DFW 53.600	7032	53	600	968077	80,8	1 p.
E4 K23 DFW 80.150	7032	80	150	968084	31,8	1 p.
E4 K23 DFW 80.200	7032	80	200	968091	37,3	1 p.
E4 K23 DFW 80.300	7032	80	300	968107	48,4	1 p.
E4 K23 DFW 80.400	7032	80	400	968114	59,4	1 p.
E4 K23 DFW 80.500	7032	80	500	968121	70,5	1 p.
E4 K23 DFW 80.600	7032	80	600	968138	81,5	1 p.
E4 K23 DFW 100.150	7032	100	150	968145	32,5	1 p.
E4 K23 DFW 100.200	7032	100	200	968152	38,0	1 p.
E4 K23 DFW 100.300	7032	100	300	968169	49,1	1 p.
E4 K23 DFW 100.400	7032	100	400	968176	60,2	1 p.
E4 K23 DFW 100.450	7032	100	450	968183	65,7	1 p.
E4 K23 DFW 100.500	7032	100	500	968190	71,2	1 p.
E4 K23 DFW 100.600	7032	100	600	968206	82,3	1 p.
E4 K23 DFW 100.750	7032	100	750	968213	98,9	1 p.
E4 K23 DFW 100.900	7032	100	900	968220	115,5	1 p.
E4 K23 DFW 150.150	7032	150	150	968237	33,5	1 p.
E4 K23 DFW 150.200	7032	150	200	968244	39,0	1 p.
E4 K23 DFW 150.300	7032	150	300	968251	50,1	1 p.
E4 K23 DFW 150.400	7032	150	400	968268	61,1	1 p.
E4 K23 DFW 150.450	7032	150	450	968275	66,6	1 p.
E4 K23 DFW 150.500	7032	150	500	968282	72,2	1 p.
E4 K23 DFW 150.600	7032	150	600	968299	83,2	1 p.
E4 K23 DFW 150.750	7032	150	750	968305	99,8	1 p.
E4 K23 DFW 150.900	7032	150	900	968312	116,4	1 p.

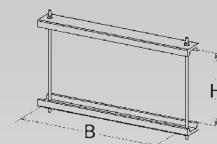

to secure the cover fixing in extreme weather conditions (strong wind)

The DFW is composed by :

- 2 GRP profiles
- 2 stainless steel threaded rods

CABLE LADDER SYSTEM ACCESSOIRES UL

Ladder fixing hold down clamp

in GRP

Item ref.	RAL colour	Material thickness (th) mm	EAN code	Weight 100 units pc	Min. pack.
K23 ULKG	7032	4	960316	3	1 p.

for the fixing of cable ladders and fittings, on the brackets KTA, FPAP

Need : 2 pieces per support

Fixing accessories for FPAP: 2 bolts M10x30 V4A per bracket, with large washer, to be ordered separately.

The maximum admissible torque is 8 Nm for the hold down clamp.

Fixing accessories for KTA : 2 bolts M6x30 V4A per bracket, to be ordered separately.

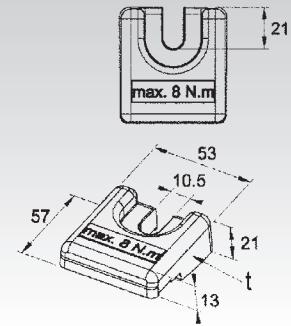

Ladder fixing hold down clamp

steel

Item ref.	EAN code	Weight 100 units	Min. pack.
E4 ULKH E4	960323	20	1 p.

for the fixing of cable ladders and fittings, on the brackets KTA, FPAP

Need : 2 pieces per support

Fixing accessories for FPAP: 2 bolts M10x30 V4A per bracket, with large washer, to be ordered separately,

The maximum admissible torque is 8 Nm for the hold down clamp.

Fixing accessories for KTA : 2 bolts M6x30 V4A per bracket, to be ordered separately.

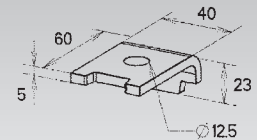

Bolt

Included nut and washer

Item ref.	Thread M	Length L mm	EAN code	Weight 100 units pc	Min. pack.
E4 BKM 6X30 E4	6	30	968336	1,7	100 p.

for fixing the cables ladders on the brackets

Also named M6x16V4A for FKM 6x16 E4, M6x20V4A for FKM 6x20 E4, M8x20PA6 for FKM 8x20 K01, M10x30V4A for SKM 10x30 E5



Dome head bolt

Included nut and washer

Item ref.	Thread M	Length L mm	EAN code	Weight 100 units pc	Min. pack.
E4 FKM 6X16 E4	6	16	962693	1,2	100 p.
E4 FKM 6X20 E4	6	20	962709	1,4	100 p.

Also named M6x16V4A for FKM 6x16 E4, M6x20V4A for FKM 6x20 E4, M8x20PA6 for FKM 8x20 K01, M10x30V4A for SKM 10x30 E4



Dome head bolt

Included nut and washer

Item ref.	Thread M	Length L mm	EAN code	Weight 100 units pc	Min. pack.
K01 FKM 8X20 K01	8	20	962716	0,4	100 p.

Also named M6x16V4A for FKM 6x16 E4, M6x20V4A for FKM 6x20 E4, M8x20PA6 for FKM 8x20 K01, M10x30V4A for SKM 10x30 E4



Hexagon head bolt

Included nut and washer

Item ref.	Thread M	Length L mm	EAN code	Weight 100 units pc	Min. pack.
E4 SKM 10X30 E4	10	30	962730	4,5	100 p.
E4 SKM 10X40 E4	10	40	962747	5,1	100 p.

Also named M6x16V4A for FKM 6x16 E4, M6x20V4A for FKM 6x20 E4, M8x20PA6 for FKM 8x20 K01, M10x30V4A for SKM 10x30 E4



Cover fixing

Item ref.	EAN code	Weight 100 units pc.	Min. pack.
K01 DF M	957927	0,2	50 p.

Used for: Cover for cable tray KKD... and KPD...
Cover for fittings KKCD..., KKBD..., KKWD..., KKBAD..., KKBID..., KKETD..., KKSTD..., KKSSD..., KKRLD... und KKRRD...

For fixing the cover, it is necessary to drill a 8,2 mm diameter hole for the diameter. In extreme weather conditions such as strong winds, for example, the quantity of clips must be increased.

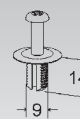

Wall-mounted angle plate

symmetrical

Item ref.	Material thickness (th) mm	Accessories/ bolts included	EAN code	Weight 100 units pc.	Min. pack.
E5 WWU 150/8 E5	4	1 SKM 8x16 E5	728909	14,62	50 p.

for mounting on the ceiling, the wall and on the floor.

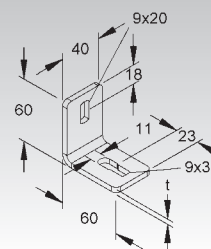

Fork-type self-locking plier

Item ref.	EAN code	Weight 100 units pc	Min. pack.
ULP 100	960347	40	1 p.

for the splice plates mounting



System
LFG



Trunking system available in heights   

 Trunking

 Divider

 Fittings

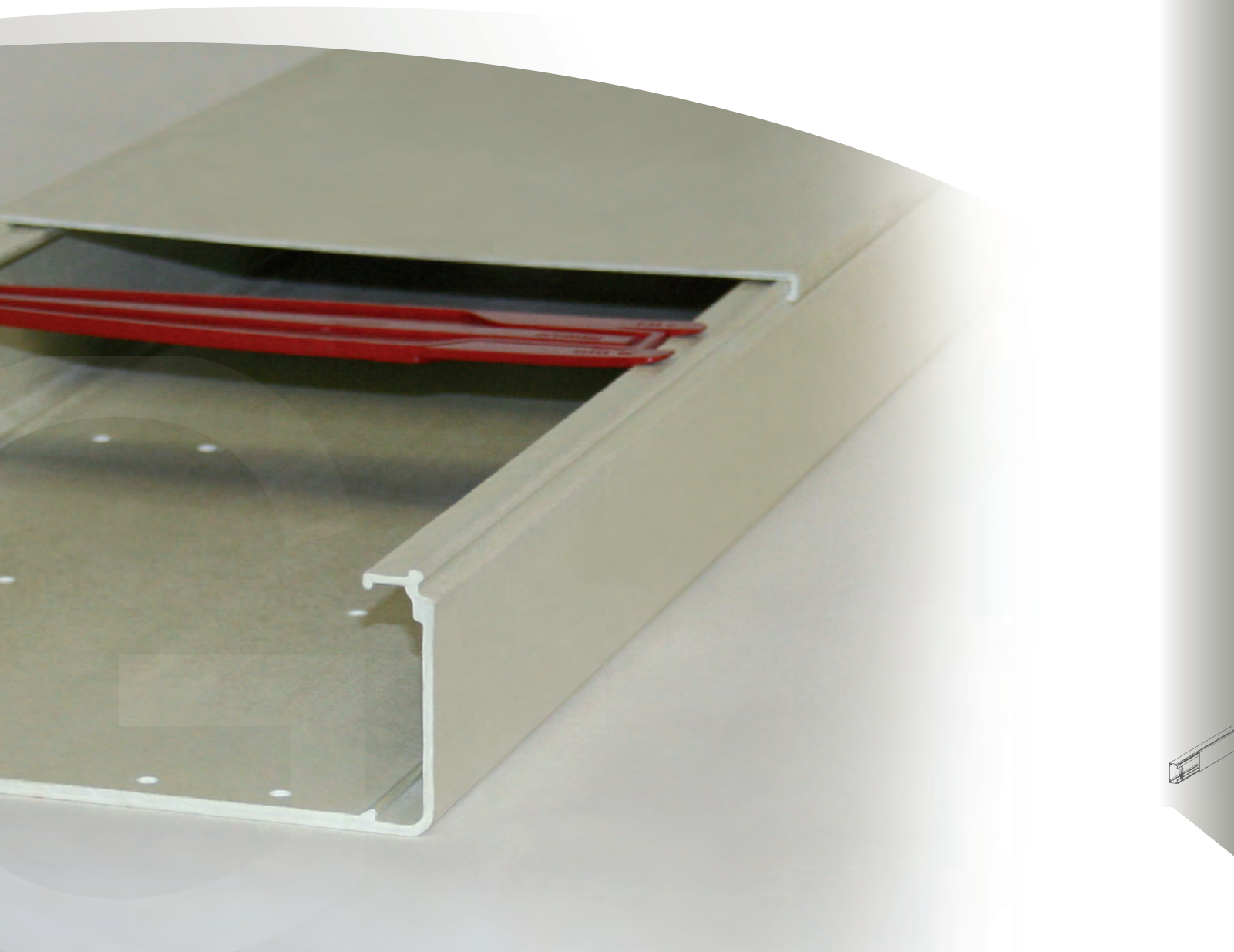































Especially used in extreme conditions trunking EBO Systems LFG in GRP is ideal in many areas such as industrial plants, factories, waste water treatment installations, refineries, offshore oil platforms, photovoltaic system, tunnels, building or food industry.

Large variations in temperature do not affect the mechanical properties of the trunking.

TRUNKING SYSTEM LFG

Available siderail heights   

SYSTEM	GRP-Trunking, pultruded	LFG	 103	 103	 103
ACCESSORIES	GRP-Splice plate with clip, pressed	KPGH 40	 103	 —	 —
	GRP-Splice plate with clip, pressed	KPGH 50	 —	 103	 —
	GRP-Splice plate with clip, pressed	KPGH 80	 —	 —	 103
	Clamp for cables holding	LFGKH	 103	 103	 103
	GRP-Endcap, pultruded	KPKE	 104	 104	 104
	GRP-Divider, pultruded	LFGT/...M	 —	 104	 104
	GRP-External elbow 90°, pultruded	LFGAC	 104	 104	 104
	GRP-Internal elbow 90°, pultruded	LFGIC	 104	 104	 104
	GRP-Horizontal elbow 90°, pultruded	LFGWC	 105	 105	 105

All trunkings and accessories are delivered with covers.

* suitable for all heights.

GRP trunking

pultruded, with cover, and cable fixing clamps

Item ref.	RAL colour	Height	Width B	Accessories/ bolts included	Material thickness (th) mm	EAN code	Weight 100 units m	Min. pack.
K23 LFG 40.060	7032	40	57	2 LFGKH 60	2,0	948567	92	2 m
K23 LFG 50.100	7032	50	100	2 LFGKH 100	2,5	948574	160	2 m
K23 LFG 50.150	7032	50	150	2 LFGKH 150	2,5	948581	205	2 m
K23 LFG 50.200	7032	50	200	2 LFGKH 200	2,5	948598	265	2 m
K23 LFG 80.100	7032	80	100	2 LFGKH 100	2,5	948604	205	2 m
K23 LFG 80.150	7032	80	150	2 LFGKH 150	2,5	948611	328	2 m
K23 LFG 80.200	7032	80	200	2 LFGKH 200	2,5	948628	424	2 m
K23 LFG 80.300	7032	80	300	2 LFGKH 300	3,2	948635	500	2 m

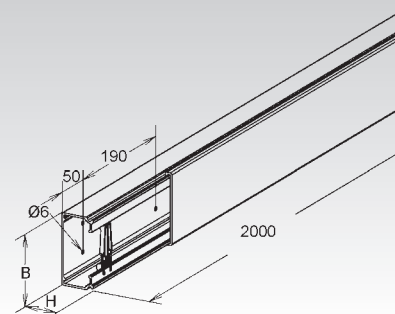

Clipsable splice plate

pressed, horizontal, fixing with bolts

Item ref.	RAL colour	Height	EAN code	Weight 100 units	Min. pack.
K23 KPGH 40	7032	25	955695	4,5	1 set

for the connection of cable trays and fittings H40, with splice plates H40

During the assembly, an expansion gap of 3 mm for dilatation must be considered.

Mounting accessories required : 2 bolts M6x20 V4A (to be ordered separately)

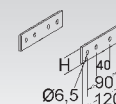

Clipsable splice plate

pultruded, horizontal

Item ref.	RAL colour	Height	EAN code	Weight 100 units	Min. pack.
K23 KPGH 50	7032	39	955701	6	1 set

for the connection of cable trays and fittings H50, with splice plates H50

During the assembly, an expansion gap of 3 mm is automatically taken in consideration.

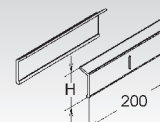

Clipsable splice plate

pultruded, horizontal

Item ref.	RAL colour	Height	EAN code	Weight 100 units	Min. pack.
K23 KPGH 80	7032	69	955718	22,5	1 set

for the connection of cable trays and the fittings H80, with splice plates H80 should be clipped on both cable trays sides.

Need: 2 pieces for each cut

During the assembly, an expansion gap of 3 mm for dilatation must be considered.

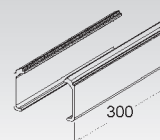

Hold down clamp for cables

Polyamid nylon

Item ref.	Width B	EAN code	Weight 100 units pc	Min. pack.
K13 LFGKH 60	38	948703	0,2	1 p.
K13 LFGKH 100	75	948710	0,6	1 p.
K13 LFGKH 150	125	948727	1,7	1 p.
K13 LFGKH 200	175	948734	17,0	1 p.
K13 LFGKH 300	275	948741	30,0	1 p.



TRUNKING SYSTEM LFG

End cap for cable tray

pultruded

Item ref.	RAL colour	Height	Width B	EAN code	Weight 100 units pc	Min. pack.
		mm	mm			
K23 KPKE 40.060	7032	40	60	955381	5,5	1 p.
K23 KPKE 50.100	7032	50	100	955398	6,0	1 p.
K23 KPKE 50.150	7032	50	150	955404	9,0	1 p.
K23 KPKE 50.200	7032	50	200	955411	10,0	1 p.
K23 KPKE 80.100	7032	80	100	955428	8,0	1 p.
K23 KPKE 80.150	7032	80	150	955435	11,0	1 p.
K23 KPKE 80.200	7032	80	200	955442	13,0	1 p.
K23 KPKE 80.300	7032	80	300	955459	20,0	1 p.

for the cable tray ends

Used for: Cable tray H50, H80, KP..., KPL... and cable trunking LFG...

Mounting accessories required : 2 bolts M6x16 V4A (to be ordered separately)

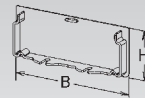

GRP separator

pultruded

Item ref.	RAL colour	Height	EAN code	Weight 100 units m	Min. pack.
		mm			
K23 LFGT 50	7032	50	948659	31	2 m
K23 LFGT 50/M	7032	50	968343	31	1 m
K23 LFGT 80	7032	80	948666	42	2 m
K23 LFGT 80/M	7032	80	968350	42	1 m

Used for: trunking LFG

For a wall mounting or a ceiling mounting, the cable tray must not be in direct contact with the surface. The separator is supplied not mounted and must be fixed with bolts inside the cable tray, in its length at a specific distance from the cable tray side

Mounting accessories required : 1 bolt M6x20 V4A per meter (to be ordered separately)

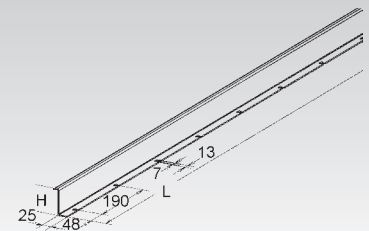

Vertical outside elbow 90°

pultruded, with cover

Item ref.	RAL colour	Height	Width B	EAN code	Weight 100 units pc	Min. pack.
		mm	mm			
K23 LFGAC 40.060	7032	40	60	948758	41	1 p.
K23 LFGAC 50.100	7032	50	100	948833	85	1 p.
K23 LFGAC 50.150	7032	50	150	948840	114	1 p.
K23 LFGAC 50.200	7032	50	200	948857	137	1 p.
K23 LFGAC 80.100	7032	80	100	948864	108	1 p.
K23 LFGAC 80.150	7032	80	150	948871	154	1 p.
K23 LFGAC 80.200	7032	80	200	948888	199	1 p.
K23 LFGAC 80.300	7032	80	300	948895	301	1 p.

Used for: trunking LFG

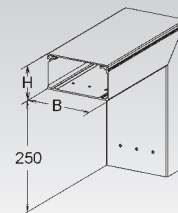

Vertical inside elbow 90°

pultruded, with cover

Item ref.	RAL colour	Height	Width B	EAN code	Weight 100 units pc/	Min. pack.
		mm	mm			
K23 LFGIC 40.060	7032	40	60	948758	31,0	1 p.
K23 LFGIC 50.100	7032	50	100	948765	65,0	1 p.
K23 LFGIC 50.150	7032	50	150	948772	86,0	1 p.
K23 LFGIC 50.200	7032	50	200	948789	103,0	1 p.
K23 LFGIC 80.100	7032	80	100	948796	72,0	1 p.
K23 LFGIC 80.150	7032	80	150	948802	100,0	1 p.
K23 LFGIC 80.200	7032	80	200	948819	112,8	1 p.
K23 LFGIC 80.300	7032	80	300	948826	239,5	1 p.

Used for: trunking LFG

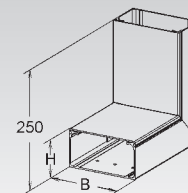

Horizontal elbow 90°

pultruded, with cover

Item ref.	RAL colour	Height mm	Width B mm	EAN code	Weight 100 units pc/m	Min. pack.
K23 LFGWC 40.060	7032	40	60	948901	30	1 p.
K23 LFGWC 50.100	7032	50	100	948918	61	1 p.
K23 LFGWC 50.150	7032	50	150	948925	76	1 p.
K23 LFGWC 50.200	7032	50	200	948932	84	1 p.
K23 LFGWC 80.100	7032	80	100	948949	72	1 p.
K23 LFGWC 80.150	7032	80	150	948956	89	1 p.
K23 LFGWC 80.200	7032	80	200	948963	99	1 p.
K23 LFGWC 80.300	7032	80	300	948970	200	1 p.

Used for: trunking LFG

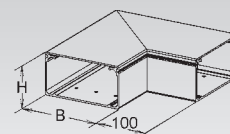

System
BK/BKS

Ground ducts system available in heights    

 Ground ducts

 Covers

 Dividers

 Accessoires

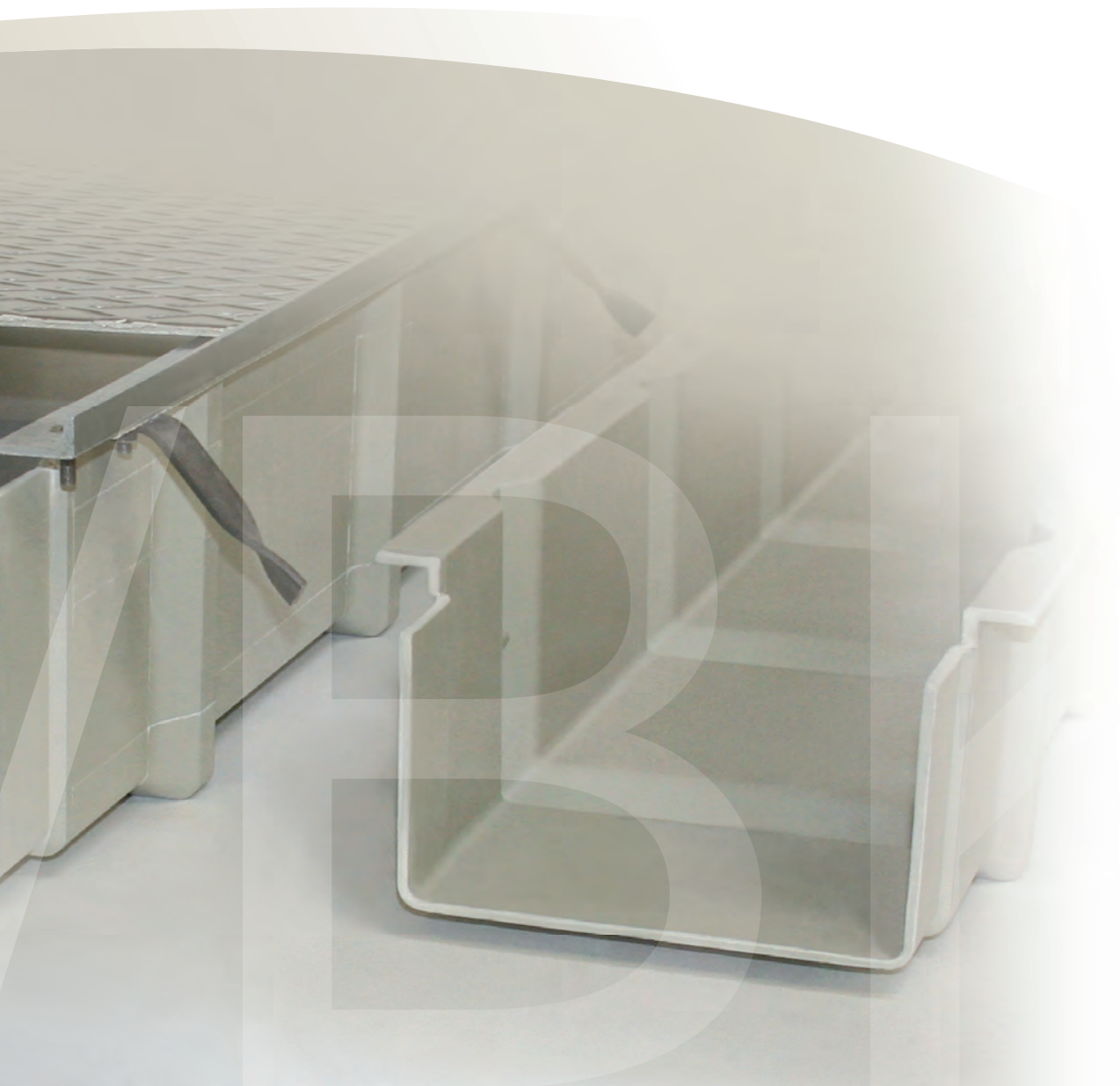

The GRP EBO Systems ground ducts has been specially designed for outdoor use, with a quick installation as well in the ground or in concrete.

The bases are supplied in lengths of 2.5 m, the connection is made by sleeving and without screws, so the installation can be done by one man.

The ground ducts will be provided with an inking system during installation in the concrete. In case of conditions of extreme loads, covers must be proposed in different thicknesses.

GROUND DUCT SYSTEM BK/BKS

Available siderail heights 

SYSTEM	GRP ground ducts, pressed	BK	109	—	109	—
	GRP divider, pressed	BKT	109	—	109	—
	GRP ground ducts, pressed	BKS	—	111	—	111
ACCESSORIES	GRP covers for ground ducts, pressed	BKDR	110			
	Cover fixing, with clips	DF 94-4	110			
	Cover fixing, with clips and hinge	DF 94-C	110			
	Cover fixing	DF M	110			
	 NEW Cover fixing	DFUB	110			
	Steel ground ducts cover	BKDR	110			

GRP ground duct

pressed, not perforated

Item ref.	RAL colour	Height	Height H1	Width B	width B1	Material thickness (th)	EAN code	Weight 100 units m	Min. pack.
		mm	mm	mm	mm	mm			
K23 BK 140.200	7032	140	124	200	192	4	952991	300,64	2,5 m
K23 BK 176.300	7032	176	160	300	292	4	953004	406,30	2,5 m
K23 BK 176.400	7032	176	160	400	392	4	953011	467,70	2,5 m

for the installation inside and on the floor

Interlocking and self-adjustable couplers, no screws required.

Load diagram : q = load evenly distributed cables (according to DIN EN IEC 61537 standard)

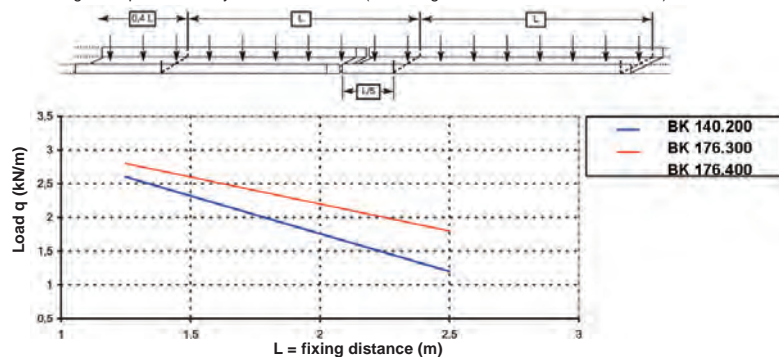

Warning : the deflection is measured with a junction position between 2 cable trays at a distance $L/5$ from the support. If this distance is not respected, it is necessary to raise the deflection values by approx. 30%.

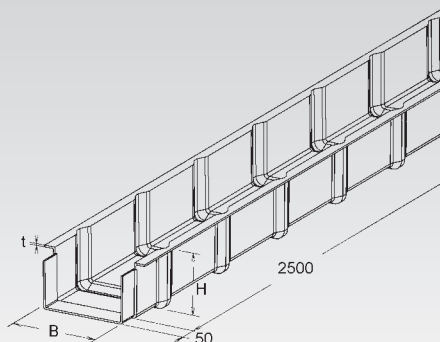
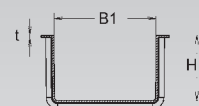

GRP separator

pressed

Item ref.	RAL colour	Height	EAN code	Weight 100 units	Min. pack.
		mm			
K23 BKT 140	7032	107	057672	49	2,5 m
K23 BKT 140/M	7032	107	057689	50	2,5 m
K23 BKT 176	7032	143	057696	66	2,5 m
K23 BKT 176/M	7032	143	057719	67	2,5 m

to separate cables with different functions and / or to separate voltages

The divider BKT... is delivered notmounted, it can be fixed in the cable tray with a bolt M 6x20V4A each 0,8 meter.

The divider BKT.../M could be delivered pre-installed (riveted), the position inside the cable tray should be defined with the order.

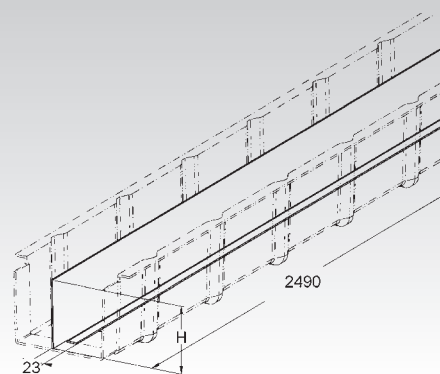

GROUND DUCT SYSTEM BK/BKS

Cover for cable ground duct

pressed, cover fixed with splice plates, with grooves on the whole surface.

Item ref.	RAL colour	Width B mm	Material thickness (th) mm	EAN code	Weight 100 units m	Min. pack.
K23 BKDR 200	7032	250	4,5	956029	296	1,3 m
K23 BKDR 300	7032	350	4,5	956036	400	1,3 m
K23 BKDR 400	7032	450	4,5	948543	528	1,3 m

Used for: Pressed ground duct BK with siderail H140 mm & H176 mm

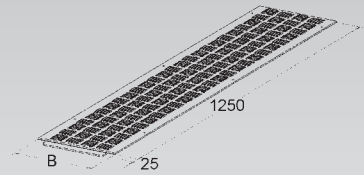
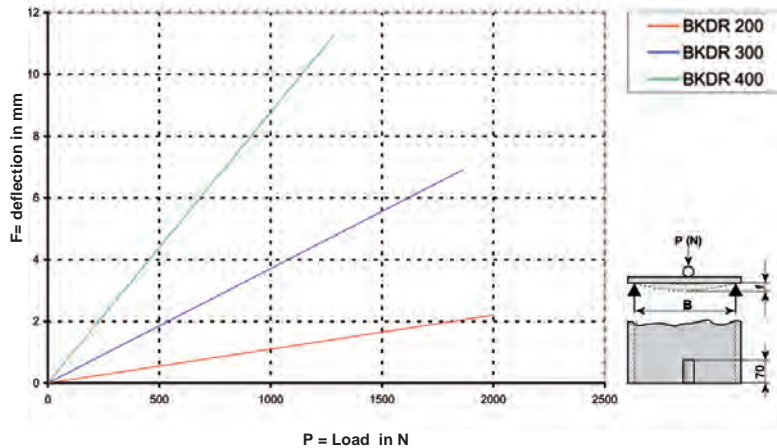

Cover fixing clip

with clip

Item ref.	EAN code	Weight 100 units pc.	Min. pack.
E4 DF 94-4 E4	948550	0,9	1 p.

for the rigid fixing of the ground duct covers

Need : 3 pieces per cover

Used for: Cover for cable ground duct BKDR 200-400

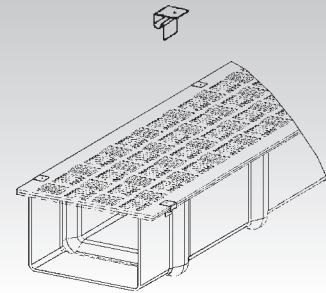

Cover fixing clip

with clip and hinge

Item ref.	EAN code	Weight 100 units pc.	Min. pack.
E4 DF 94-C E4	957866	10	1 p.

for fixing covers on cables trays

Need : 3 pieces per cover

Used for: cover for cable ground duct BKDR 200-400

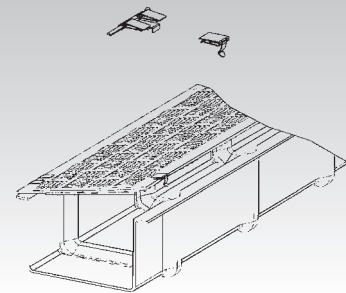

Cover fixing

Item ref.	EAN code	Weight 100 units pc.	Min. pack.
K01 DF M	957927	0,2	50 p.

Used for: Cover for cable tray KKD... and KPD...

Cover for fittings KKCD..., KKBD..., KKWD..., KKBAD..., KKBID..., KKETD..., KKSTD..., KKSSD..., KKRLD... und KKRRD...

For fixing the cover, it is necessary to drill a 8,2 mm diameter hole for the diameter. In extreme weather conditions such as strong winds, for example, the quantity of clips must be increased.

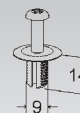

Cover fixing

Item ref.	EAN code	Weight 100 units	Min. pack.
E4 DFUB 5.5X19 E4	062065	0,64	50 p.

Used for: Cover for cable tray KKD... and KPD...
Cover for fittings KKCD..., KKBD..., KKWD..., KKBAD..., KKBID..., KKETD..., KKSTD..., KKSSD..., KKRLD... und KKRRD...

For fixing the cover, it is necessary to drill a 8,2 mm diameter hole for the diameter. In extreme weather conditions such as strong winds, for example, the quantity of clips must be increased.

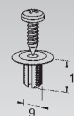

Cable tray for a ground installation

pressed, not perforated

Item ref.	RAL colour	Height mm	Height H1 mm	Width B mm	width B1 mm	Material thickness (th) mm	EAN code	Weight 100 units m	Min. pack.
K23 BKS 155.200	7032	155	131	200	192	4	962303	354,40	2,5 m
K23 BKS 191.300	7032	191	167	300	292	4	962310	462,02	2,5 m
K23 BKS 191.400	7032	191	167	400	392	4	962327	525,40	2,5 m

to install on the ground, on earth or on concrete

Warning : orientable concrete anchorage

Interlocking and self-adjustable couplers, no screws required

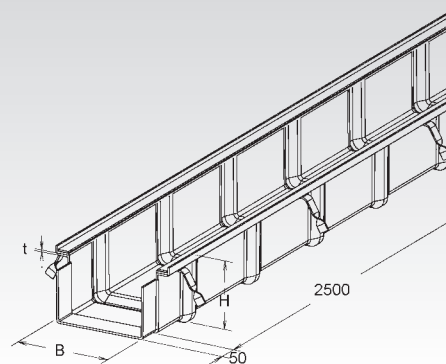
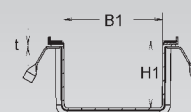

Steel cover for cable tray

with a grooved steel cover on the whole surface

Item ref.	Width B mm	Material thickness (th) mm	EAN code	Weight 100 units m	Min. pack.
F BKDR 200-5 F	250	5	956043	1.089,1	1,3 m
F BKDR 300-5 F	350	5	956050	1.524,1	1,3 m
F BKDR 400-5 F	450	5	956067	1.955,9	1,3 m
F BKDR 200-8 F	250	8	956074	1.736,5	1,3 m
F BKDR 300-8 F	350	8	956081	2.430,6	1,3 m
F BKDR 400-8 F	450	8	956098	3.121,4	1,3 m

Used for: Heavy duty ground duct BKS with siderail H155 & H191 mm

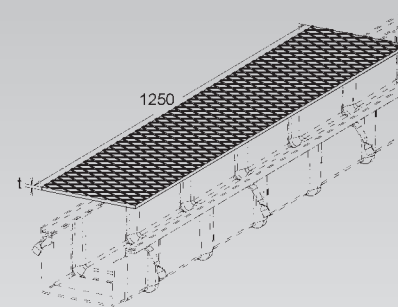
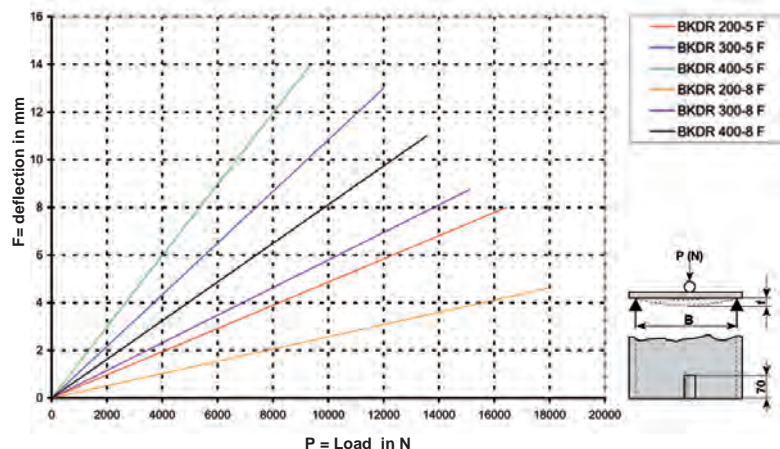

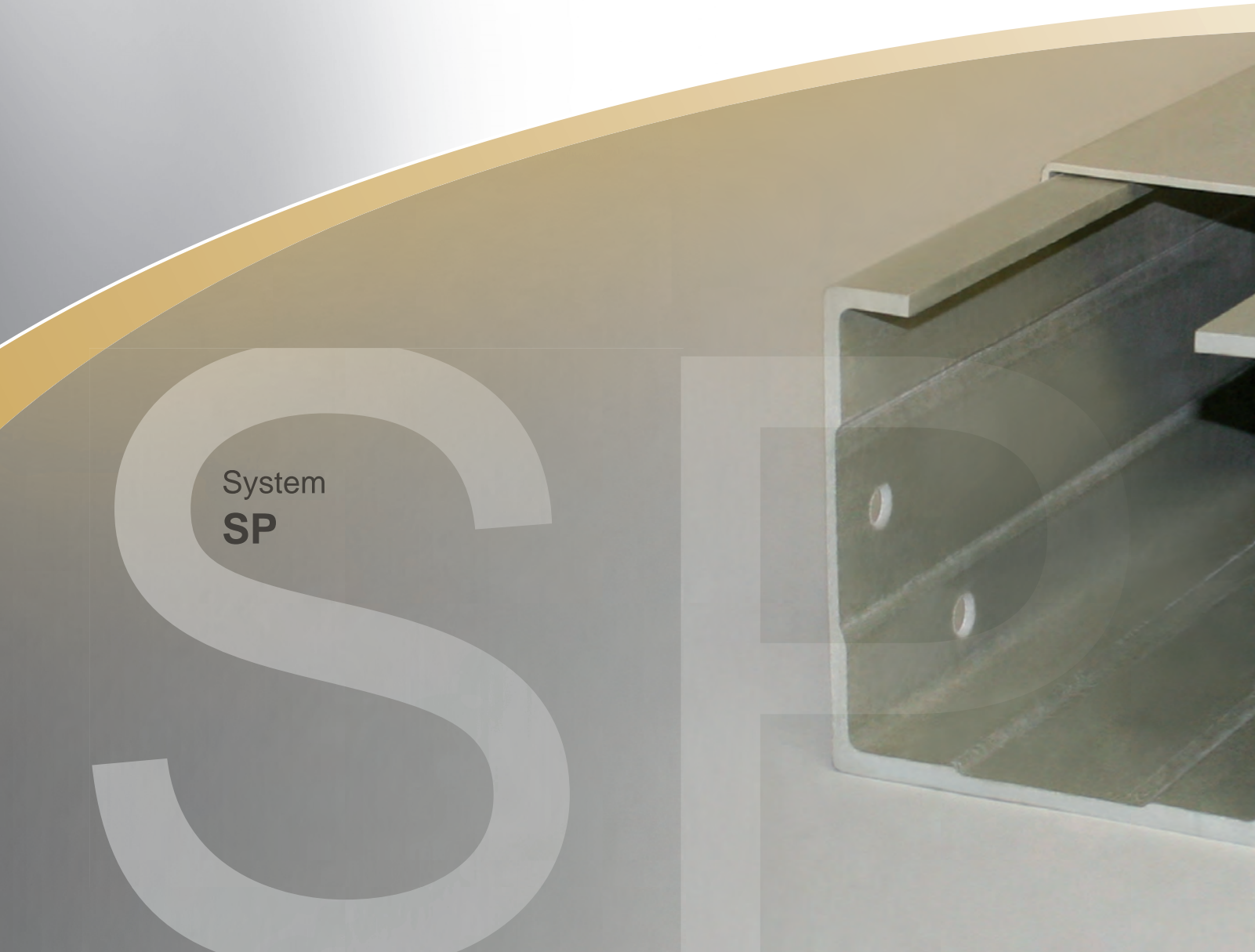

Self standing cable troughing system

-  Self standing cable troughing system for railways

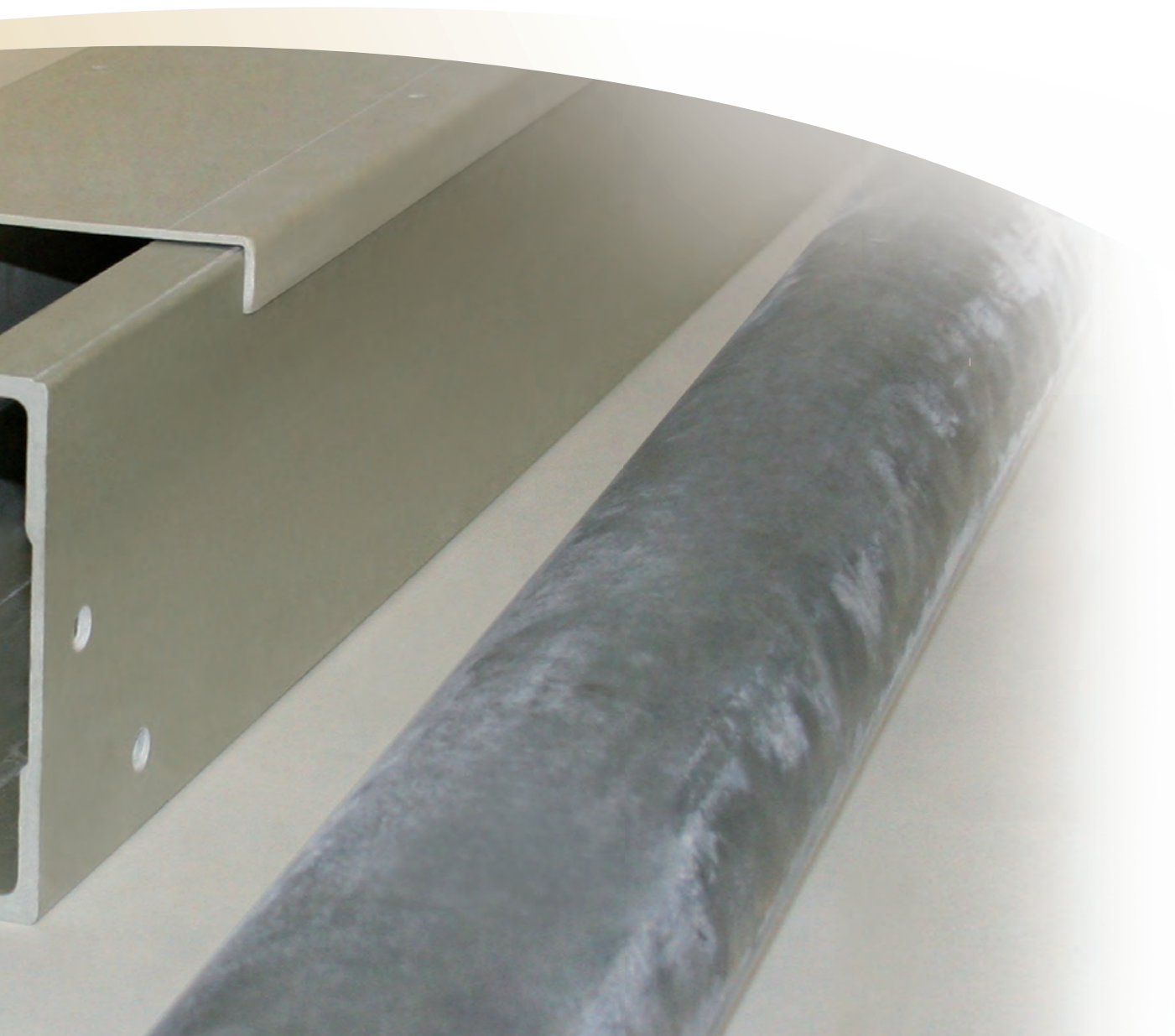

The GRP EBO Systems cable troughing SP is an innovative product, validated by the Deutsche Bahn and S-Bahn Berlin, it is particularly suitable in the facilities, impassable infrastructure, inaccessible environments, or dented places .

A flexible and economical installation due to the use of a system for supporting and fixing HDG. Lightweight lengths of 6m, perforations and lateral sides of the preassembled connecting fasteners allow a quick and easy installation.

Stand-System SP

Material K23

- no corrosion
- extremely insulating material, no need to earth
- dielectrical resistance 30 kV with a certificate issued by IPH Berlin
- fire retardant property according to UL 94 : class V0
- halogen free
- UV resistant
- recyclable

Mounting

- low weight
- Easy installation
- Delivered with perforations
- Delivery length 6 m
- Pre-assembled connectors allows a quick assembly
- The continuous installation allows variations of distances between supports
- the height of the system can be adjusted with variable pole lengths
- Particularly adapted to various topographical conditions

Load resistance

High mechanical resistance according to the specifications of the Federal Bureau of railways and Mannesmann Arcor (Vodafone).

- Homologation number: EBA / 21AZ2 / 0029/9 du 16.11.1999
- Approved by DB Systel GmbH: T.SVN 15 10/12 du 27.05.2010

DB Mobility
Networks
Logistics

S

DB Systel GmbH
T.SVN 15
0890 761-48559
Intern 955-48559

Seitenfreigabe für Material der Telekommunikationstechnik

Freigabemr.: SF T.SVN 15 10/12

Für den Einsatz bei der DB AG werden freigegeben:

Bezeichnung	Hersteller-Artikelnr.	DB-Materialnummer
Aufgeändertes GFK-Kabellührungssystem		
SP Gb. 1	SP150150W	00975398
SP Gb. 2	SP250150W	00975453

TK-Anlagen mit Sicherheitsaufgaben gemäß EBA-Vorschriften: ja nein

Bemerkungen (Verwendungszweck, Bestimmungsort, Ersatz für, usw.)

Bei schwierigen bzw. unregelmäßigen Geländeverhältnissen bei denen die typischen Kabellührungssysteme wie erdverlegte Kabeltröge, Erd-, Luft- und Rohrtragsassen nicht zur Anwendung kommen können, dienen die aufgeführten Kabelkanäle zur Aufnahme und Führung von Signal-, TK-, und Sensorenkabeln bei der DB AG.

Die Seitenfreigabe des Kabellührungssystems erfolgt auf Basis des Lieferanten „Kabelkanäle aus Kunststoff“ vom 01.08.2002, den Erfahrungen der bisher aufgegebenen Strecken und der Produktdokumentation EBO-Systems Version 02/08 vom September 2008, inkl. Montageanleitung. Dieses Kabellührungssystem ist identisch mit dem System der Freigabe SF H-TIN 08/03.

Die Bemerkungen auf Seite 2 und die Liste der freigegebenen Zeichnungen auf dem Seiten 3 und 4 sind zu beachten.

Hersteller: Ebo Systems S.A.S., Zone Industrielle - B.P. 5
F-54920 Viller-sous-Montagne
Vertrieb: NIEDAX GmbH & Co.KG, Alsbacher Str. 141,
53145 Linz / Hhein
Koper: LNV722, Ebo Systems und NIEDAX GmbH

Eschborn, 27.05.2010

(Freigabebew.) *(Freigabebew.)*

Seite 1 von 4

Federal Bureau of railways/Deutsche Bundesbahn



○ **Self standing cable troughing system SP**
a compact system for the elevation and cables support along railways

- cable trays with removable cover
- self standing cable trays up to 6 m
- supporting pole in HDG material
- pole head in HDG material
- cover fixing with anti-theft bolts



**Contact
US**
for solutions adapted to
your special projects

Stand-System SP

Posts and post head fixing unit

Because of the shape of the pole head a height adjustment is possible. During installation on uneven ground, the swivel-mounted post head allows adjustment in three directions. The post head-fixing unit is a single piece, thus making it easy and quick to install. All the bolt fittings are standard size M10x25. A possible shift of the post position during installation can be overhauled thanks to the oblong holes on the top of the post head.



Adjustable post head in 3 directions



Post head adjustable in 2 directions

Covers



Overlapping covers through sleeves

Overlapping of the covers through sleeves avoids the infiltration of water.

The GRP cover is fixed with impregnable screw, type Torx, and a cage nut.



Impregnable screw, type Torx

Splice plates

The U-shaped connector made in 316 stainless steel secures perfectly the junction of each tray. Each 6 m length is delivered pre-assembled with a junction bolted on one side. The systems has been designed to be assembled by a single person whenever it is required. All the screws are round headed screws to avoid any cable injury. During the installation a 6 mm gap must be allowed between the tray lengths, and an 8 mm space between the tray covers.



Splice plate pre-assembly in the factory



Round headed screws, observed an expansion joint

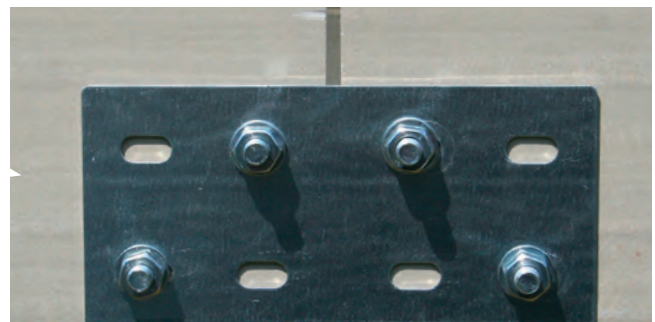

Order of the screws

Divider



Divider

For the separation of the cables (with different fonctions and/or according voltages).

The divider is maintained at the bottom of the tray through the cable weight, thus no additional hardware required during installation.

Stand-System SP

Rectangular cables spare

Fitting non-symmetrical, rectangular 1500 mm x 500 mm.
The connection system to the cable tray is integrated.

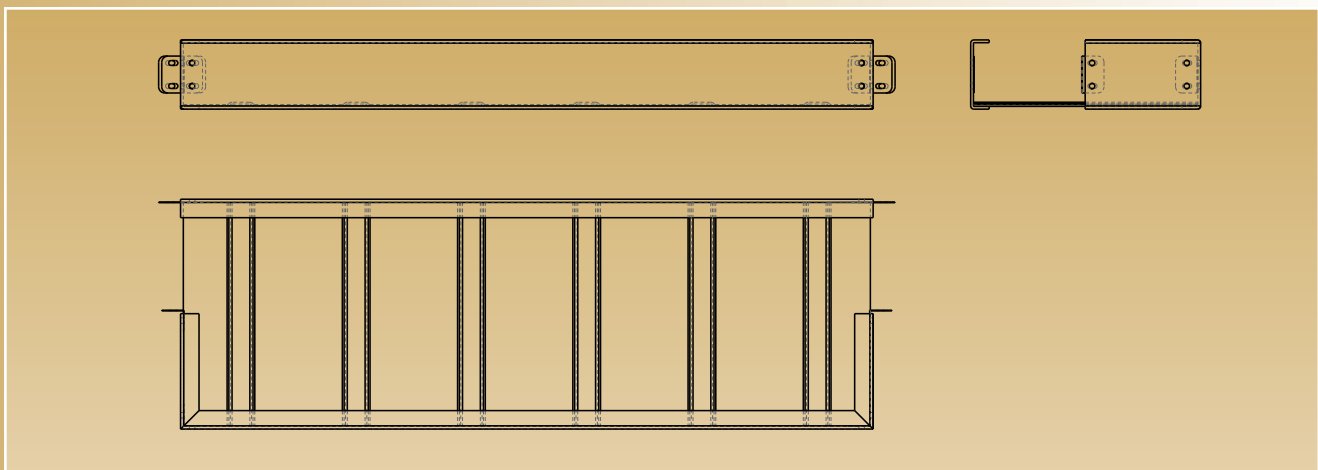
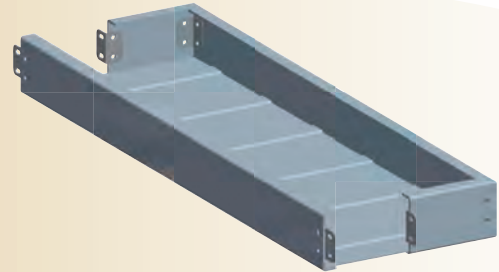

Symmetrical cables spare

The fitting is symmetrical, the center piece measured
4500mm x 500 mm and 6000 mm in total, included coupling.
The connection system to the cable tray is included.

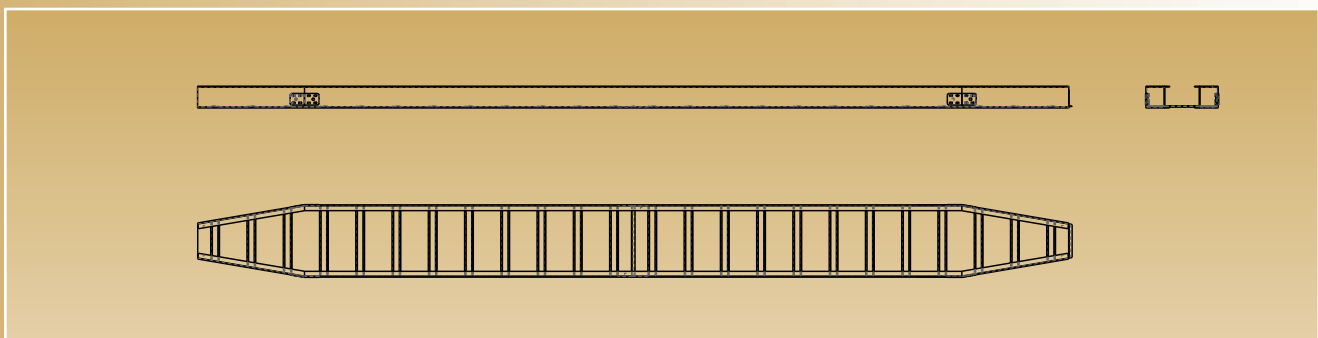
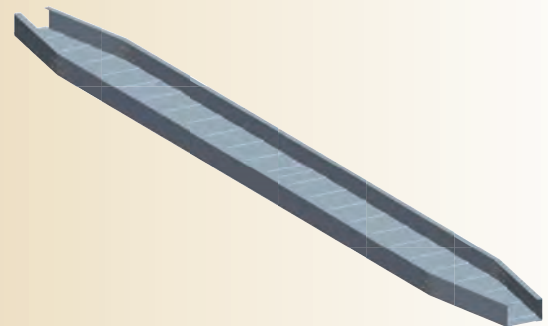

Instructions for assembly

Cable tray SP stand-system view profile

150 mm

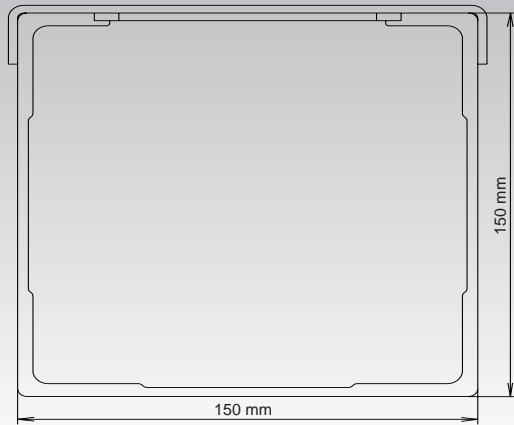

250 mm

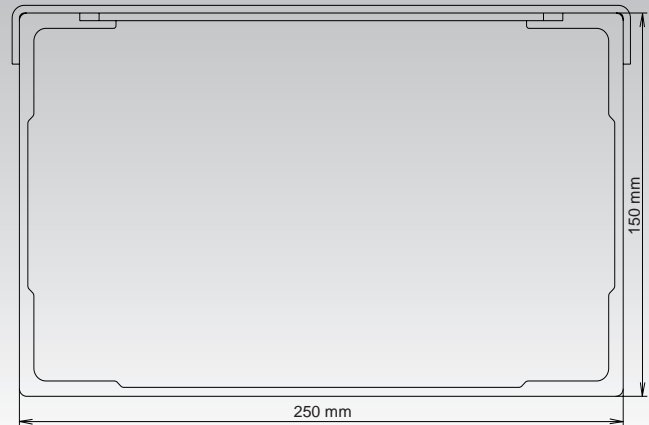

Assembling the stand-SP system to support distance of 3 m

After installing the first post, the second will be installed at a distance of about 2.25 m to respect the position of the holes in the bottom of the base.

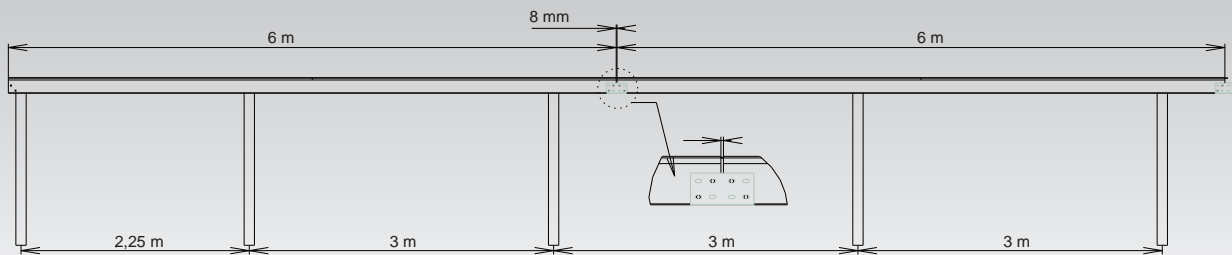

Assembling the stand-SP system to support distance of 6 m

After installing the first post, the second will be installed at a distance of about 4.50 m to respect the position of the holes in the bottom of the base.

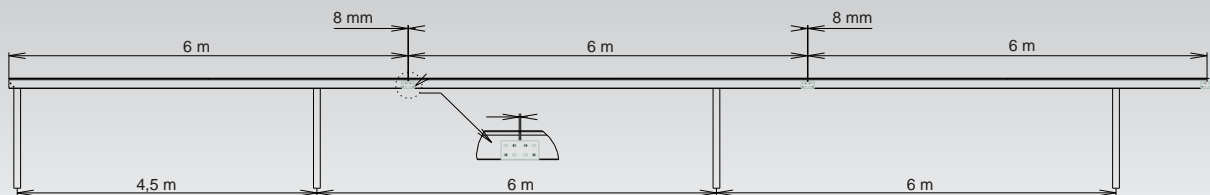

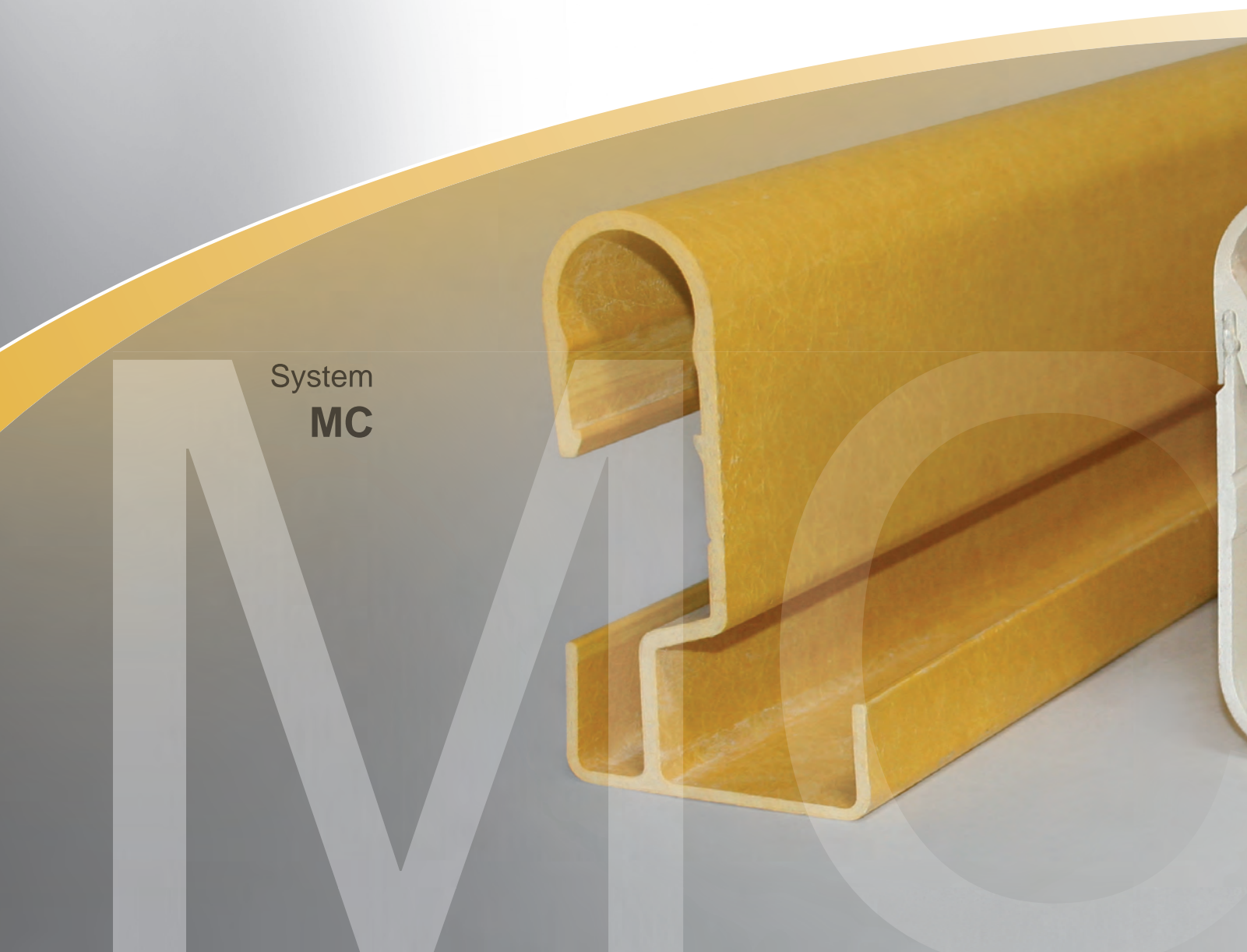

Handrail system

- Handrail profiles
- End cap
- Accessoires

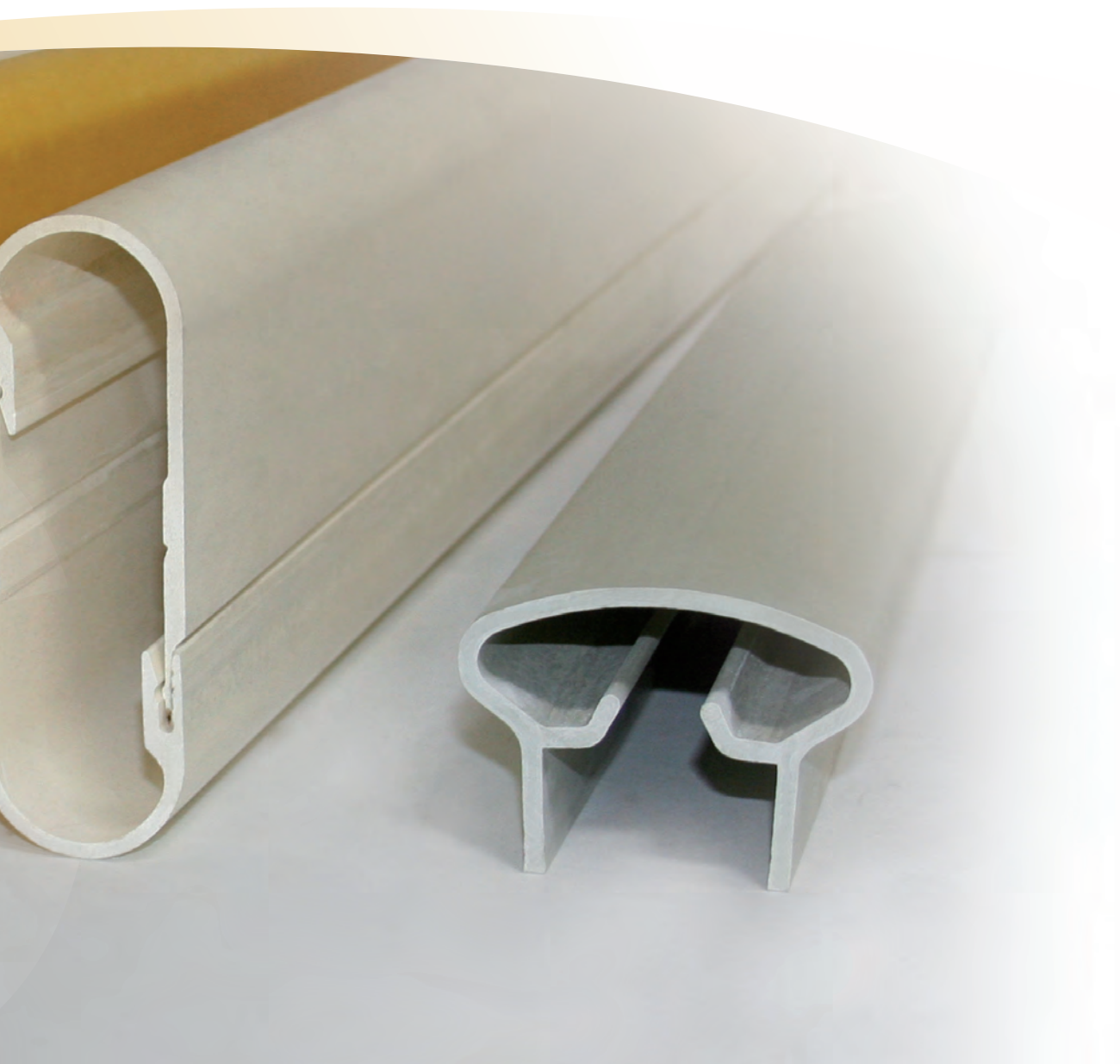

EBO Systems GRP handrails are ideal in tunnels and industrial facilities since a double function: support cables and help users find the exits in case of fire hazard.

These handrails can also be used as a security system in all hallways, corridors and stairwells.

We offer handrails incorporating closed or not passages, with cables or not, with optional lighting of safety equipment.

System overview of handrails

SYSTEM	GRP-Handrail	PR-MC 10	123
	GRP-Handrail	PR-MC 22	124
ACCESSORIES	GRP-Handrail coupler	PR-MC 10 GH	123
	GRP-Wall mounting angle plate	PR-MC 10 GM	123
	GRP-End cap	PR-MC 10 KE	123
	Polyamid bolts	PR-M860/PA6	123
	GRP-Riveted end cap	PR-MC 22 KE	124
	GRP-Clipsable end cap	PR-MC 22 KE/C	124
	GRP-Half end cap	PR-MC 22 KE/P	124
	GRP-Clipsable half end cap	PR-MC 22 KE/CP	125
	Supporting clamp E30	PR-MC 22 HBV	125
	GRP-Lighting support	PR-MC 22 BA	123
	GRP-Handrail	PR-MC 30	126
	GRP-Handrail coupler	PR-MC 30 IH	126
	GRP-Riveted end cap	PR-MC 30 KE	126
	Supporting clamp E30	PR-MC 30 HBV	126

Handrail

pultruded, with integrated cable tray

Item ref.	RAL colour	EAN code	Weight 100 units m	Min. pack.
K23 PR-MC 10	7032	965489	135	1 m

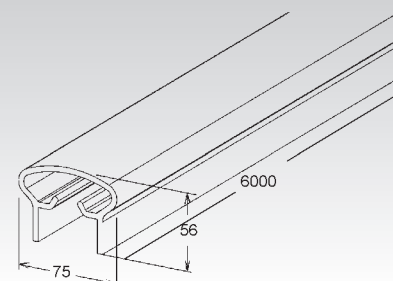

Splice plate

pultruded

Item ref.	RAL colour	Height mm	Width B mm	EAN code	Weight 100 units pc	Min. pack.
K23 PR-MC 10 GH	7032	20	150	968367	9	1 p.

Used for: Handrail PR-MC 10

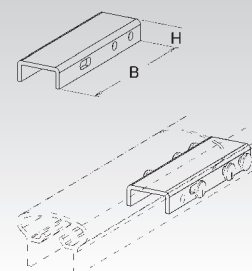

Wall-mounted angle plate

pressed

Item ref.	RAL colour	Height mm	Width B mm	EAN code	Weight 100 units pc	Min. pack.
K23 PR-MC 10 GM	7032	90	95	968374	15,6	1 p.

for the lateral handrail fixing on site

Used for: Handrail PR-MC 10

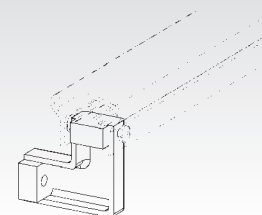
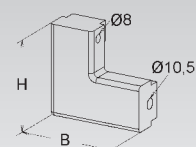

Handrail end cap

pressed

Item ref.	RAL colour	EAN code	Weight 100 units pc	Min. pack.
K23 PR-MC 10 KE	7032	968381	10	1 p.

for covering the profile ends

Used for: Handrail PR-MC 10

The end cap must be riveted on both sides

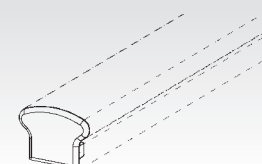

Polyamid bolt

Item ref.	EAN code	Weight 100 units pc	Min. pack.
K01 PR M860/PA6	968398	135	1 p.

for fixing the handrail on the wall-mounted angle plate

Used for: Handrail PR-MC 10

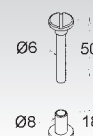

HANDRAIL SYSTEM MC

Handrail

pultruded, 2 pieces, with integrated cable tray

Item ref.	RAL colour	EAN code	Weight 100 units m	Min. pack.
K23 PR-MC 22	7032	965496	900	3 m

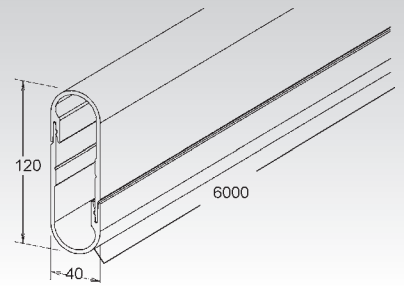

Riveted handrail end cap

pressed

Item ref.	RAL colour	EAN code	Weight 100 units pc	Min. pack.
K23 PR-MC 22 KE	7032	966172	3,4	1 p.

for covering the handrail ends

For more safety, we recommend to add reflectors.

Used for: Handrail PR-MC 22

The reflectors will be added on request (to be ordered separately)

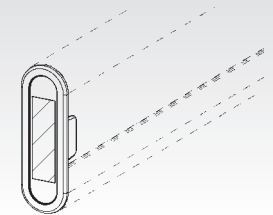
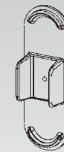

Clipsable handrail end cap

pressed

Item ref.	RAL colour	EAN code	Weight 100 units pc	Min. pack.
K23 PR-MC 22 KE/C	7032	966196	3,9	1 p.

for covering the handrail ends

For more safety, we recommend to add reflectors.

Used for: Handrail PR-MC 22

The reflectors will be added on request (to be ordered separately)

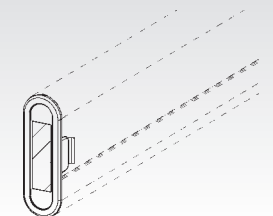
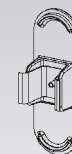

The half end cap must be riveted

pressed

Item ref.	RAL colour	EAN code	Weight 100 units pc	Min. pack.
K23 PR-MC 22 KE/P	7032	966189	1,6	1 p.

for covering the handrail ends

For more safety, we recommend to add reflectors.

Used for: Handrail PR-MC 22

The reflectors will be added on request (to be ordered separately)

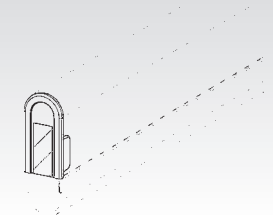

The half end cap must be clipped

pressed

Item ref.	RAL colour	EAN code	Weight 100 units pc	Min. pack.
K23 PR-MC 22 KE/CP	7032	966202	1,8	1 p.

for covering the handrail ends

For more safety, we recommend to add reflectors.

Used for: Handrail PR-MC 22

The reflectors will be added on request (to be ordered separately)

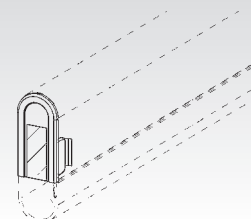

Hold down clamp for cables E30

stainless steel

Item ref.	EAN code	Weight 100 units pc	Min. pack.
E3 PR-MC 22 HBV	966219	9	1 p.

Used for: Handrail PR-MC 22

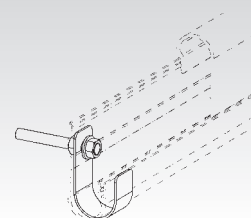
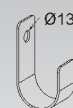

Lighting support

pressed

Item ref.	RAL colour	EAN code	Weight 100 units pc	Min. pack.
K23 PR-MC 22 BA	7032	966158	75	1 p.

for the display of emergency exits on the handrail profile

Used for: Handrail PR-MC 22

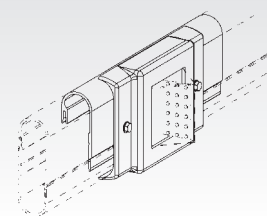
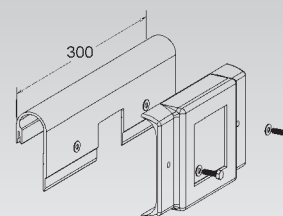

HANDRAIL SYSTEM MC

Handrail

pultruded, 2 pieces, with integrated cable tray

Item ref.	RAL colour	length unit	EAN code	Weight 100 units m	Min. pack.
K23 PR-MC 30	7032	6 m	965502	450	3 m

to separate the low voltage and high voltage cables

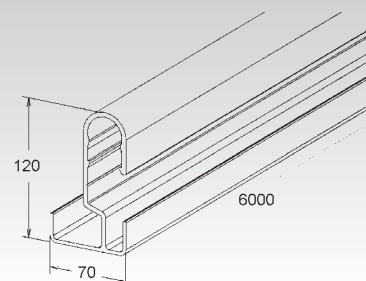

Clipsable splice plate

stainless steel

Item ref.	EAN code	Weight 100 units pc	Min. pack.
E4 PR-MC 30 IH	966226	9	1 p.

Used for: Handrail PR-MC 30

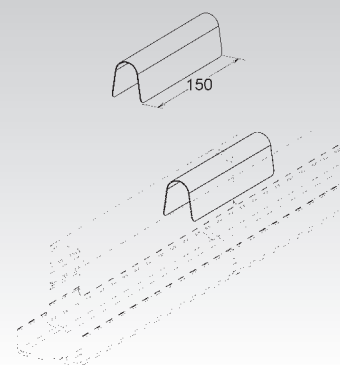

End cap, (clippable)

pressed, with reflector on request

Item ref.	RAL colour	EAN code	Weight 100 units pc	Min. pack.
K23 PR-MC 30 KE	7032	966233	4,1	1 p.

for covering the handrail ends

For more safety, we recommend to add reflectors.

Used for: Handrail PR-MC 30

The half end cap must be riveted on both sides

The reflectors will be added on request (to be ordered separately)

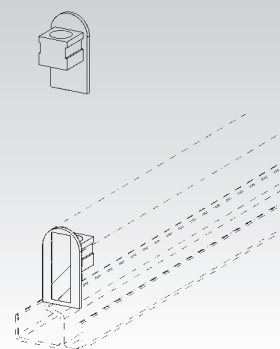

Wall-mounted angle plate E30

stainless steel

Item ref.	EAN code	Weight 100 units	Min. pack.
E3 PR-MC 30 HBV	968404	135	1 m

Used for: Handrail PR-MC 30

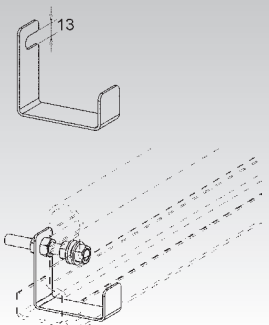

NOTES

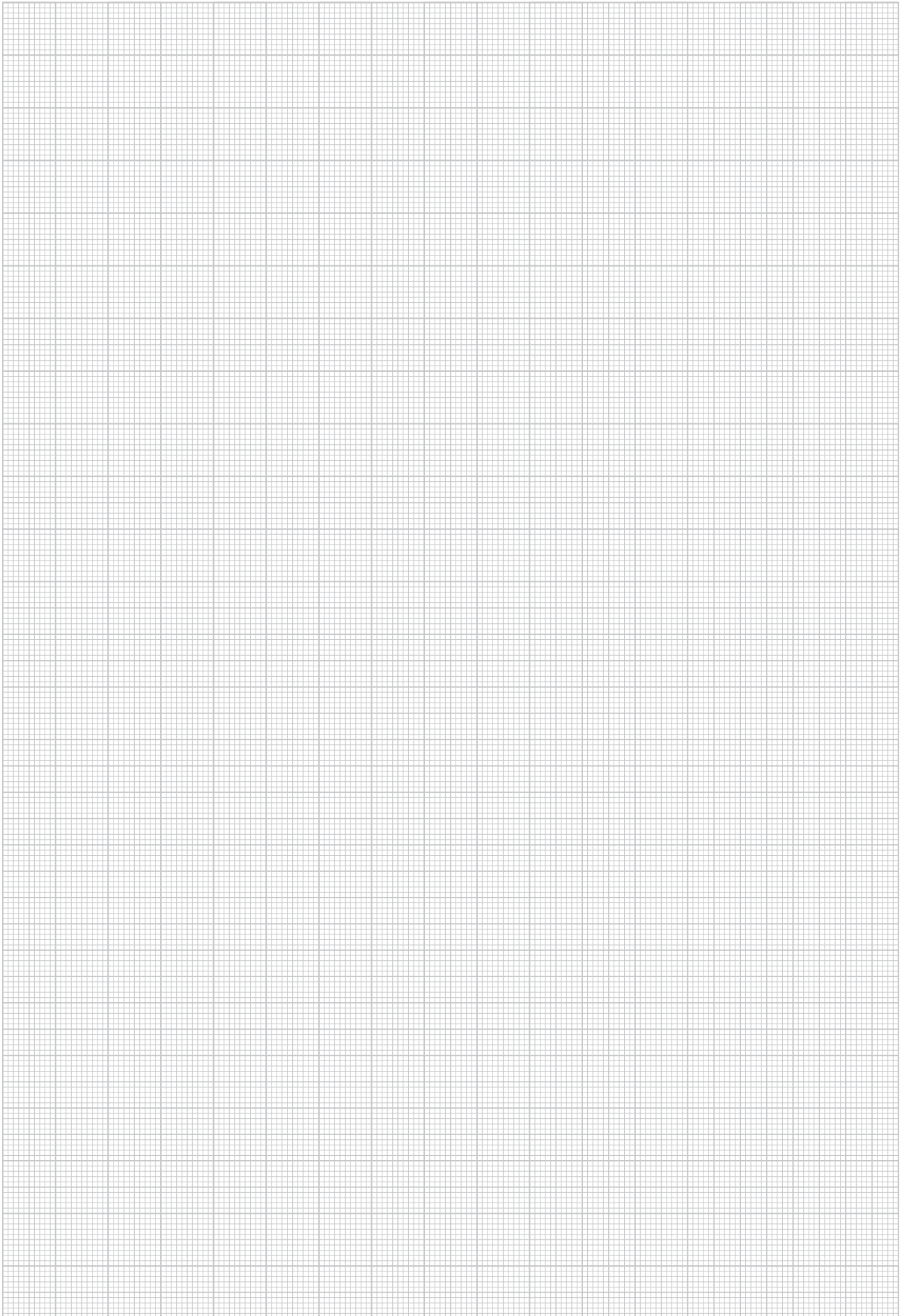



Information

- Thermoset resins
- Plastic
- Galvanizing process

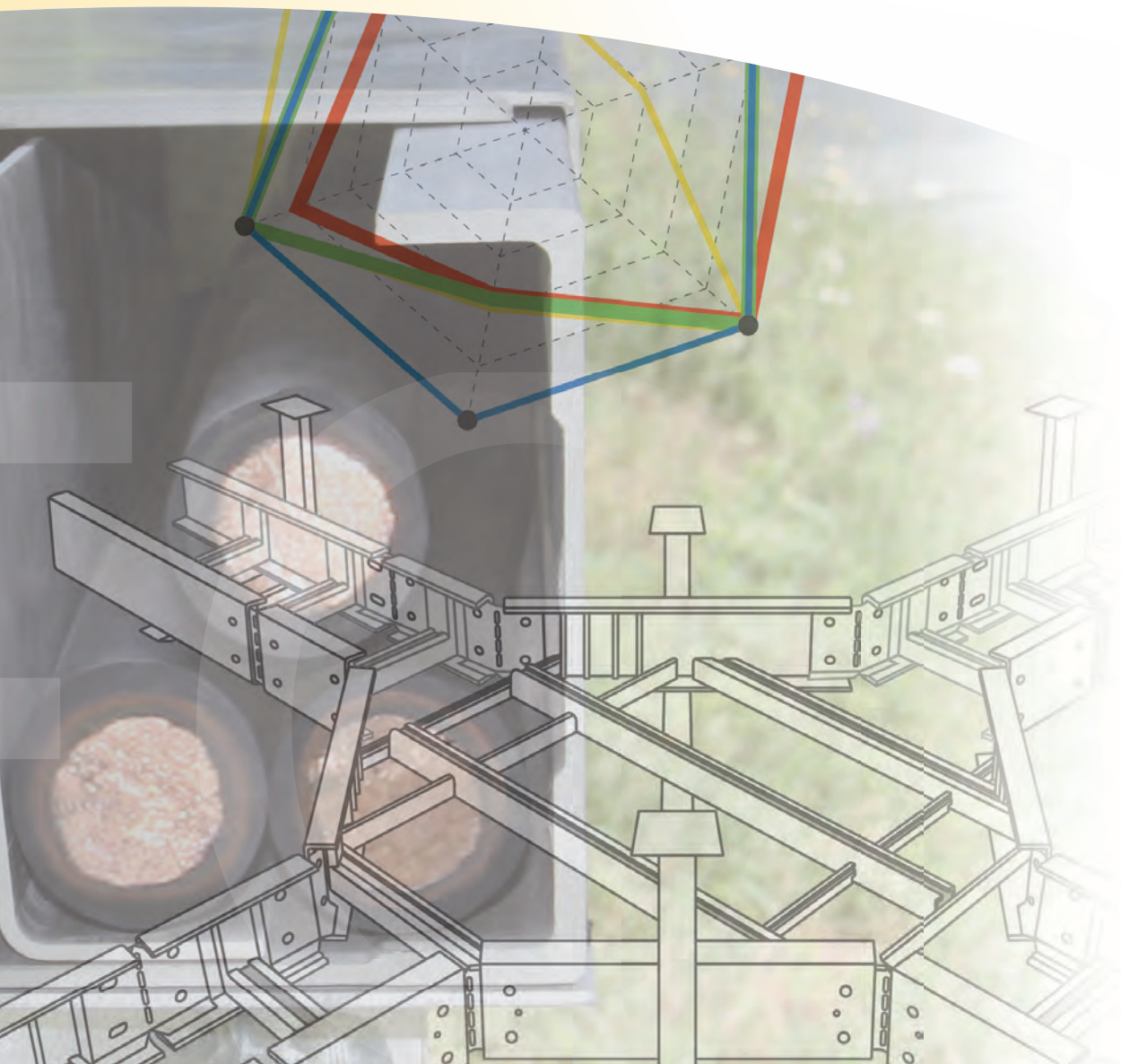

On the following pages are gathered for you the most important information on GRP cable tray systems with EBO Systems brand.

For more information you can contact us by calling +33 3 82 44 01 07 or by sending an email to: info@ebo-systems.com

Thermoset resins

- Thermoset resins reinforced with glassfiber mats and glassfiber rovings allow to obtain products of a very high holding strength and mechanics. Thermoset plastics after processing can not be deformed under the effect of heat. The thermoset resins used by Ebo Systems have very high chemical and physical properties. The use of these polyester resins, charged with glassfibers, allow to obtain composite products, highly resistant to corrosion, electrically insulating with excellent mechanical characteristics, highly heat-resistant in comparison with other plastics (PVC , ABS). This material has a very high fire resistance, with self-extinguishing and flame retardant properties, without the addition of halogenated products by the use of mineral materials. It can be possibly used for specific applications and EBO Systems has the possibility to adapt these recipes based on other requirements (special colors, special antistatic properties, etc ...).

Ebo Systems exists for over 50 years and has developed its recipes to achieve these properties while maintaining high quality and innovative products.

The expertise of Ebo Systems is its ability to always find new recipes, develop new products which comply with the customer requirements at the fairest price.

- ### Polyester Resin

For the standard product range, a polyester resin is often used. This allows to reach the main requirements in force and with many adjuvants, up to 21 different, Ebo Sytems can meet some properties with a price / quality / level of service / very high report.

- ### Carbon loaded polyester resin

The carbon loaded polyester resin is used in explosive environments where it is necessary to prevent the accumulation of electrostatic charges by connecting the cable tray to the ground, when the humidity is below 50%.

- ### Acrylic resin

This acrylic resin is used in niche markets to meet the most stringent fire and smoke standards, particularly in the case of underground long tunnels where the requirement for non-flammable products is very high. This is the case of special tunnels as the Channel Tunnel where cable trays provided by Ebo Systems were made exclusively with an acrylic resin.

- ### Vinylester resin

This resin is used in highly corrosive environments and in highly concentrated chemical environments.

Select your resins according to your technical specifications

Current corrosive atmosphere		
	Environmental features ex: side of the sea, plateforme de forage	Environmental features ex: tunnel
Environnement:	Strong atmospheric type corrosion (ex.: side of sea)	Risk of fire in enclosed and corrosive environment (ex.: long tunnels)
Avantages:	A very good holding in the time, a good behavior to fire, without risk, for an optimal cost	An excellent resistance to fire for a maximal security
Our recommendation:	Polyester resin Self-extinguishing polyester 0% halogen	Acrylic resin Self-extinguishing acrylic 0% halogen

Specific corrosive atmosphere		
	Environnemental features ex: mine gas groups I	Environnemental features ex: in the galvanizing environment
Environnement:	Highly exploding atmosphere (ex: mines, gas groups I)	Strong content of highly corrosive chemical agents (ex : H ₂ SO ₄ , HCl, ...)
Avantage:	The antistatic properties	A high resistance to the chemical corrosion
Our recommendation:	Carbon loaded polyester 0% halogen	Vinylester 0% halogen

The nearer the curve to the outside of the hexagone, the better the solution.

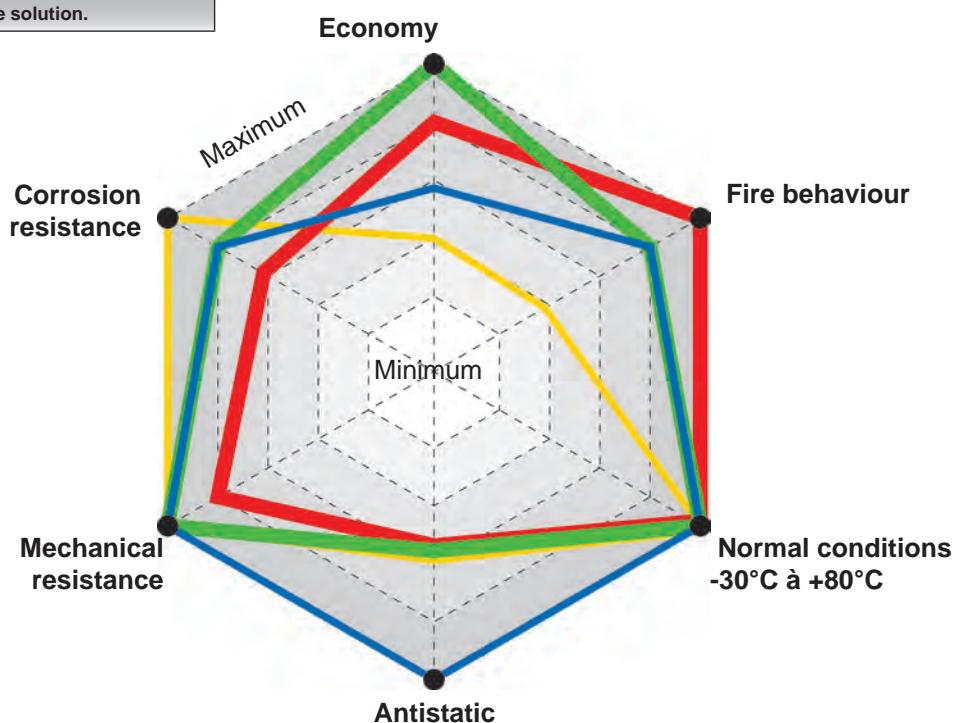

Plastic materials

Modification of plastic

To ensure the installation it is best to store the paths Ebo Systems cable before installing to temperatures higher than 0° C and less than 40° C. However, the cable tray may be stored at temperatures - 40° C to over 150° C

Symbol catalog	Abbreviation	Material name	Temperature zone, always	Mechanical properties	Application (Exemples)	Stress cracking
K01	PA	POLYAMIDE	-30°C to 80°C	compact, hard, very hard, very sharp, abrasive	Attaching cables, shims maintains fixing cables, mounting clip	low
K02	PS	POLYSTYRENE	-30°C to 60°C	deformable inner drive, compact, very hard	Attaching cables, mounting clamps, against fixing	intense
K03	PE	POLYETHYLENE	-40°C to 80°C	soft to hard, sharp, low behavior	Protective caps, against fixing	intense
K04	PP	POLYPROPYLENE	-40°C to 90°C	compact form, hard, full, slightly malleable	Bottom bracket, clamp, needle attachment	possible
K05	PC	POLYCARBONATE	-40°C to 120°C	high hardness, hardness and elongation, impact resistance	A fi xing clip	possible
K06	SBR/ NBR	STYRENE BUTADIENE RUBBER/ NITRILE BUTADIENE RUBBER	-30°C to 100°C	good abrasion resistance and weather	Toric seal	no
K07	CR	CHLOROPRENE RUBBER	-40°C to 120°C	good resistance to chemicals and aging	Toric seal	no
K08	NBR	NITRILE BUTADIENE RUBBER	-40°C to 120°C	flexible cold, high elasticity, low resistance to extreme conditions	Toric seal	no
K09	PVC	POLYVINYL CHLORIDE	-20°C to 65°C	compact holding hardness, shear sensitive	Plastic trunking	low
K10	SOFT-PVC	SOFT POLYVINYL CHLORIDE	0°C to 50°C	flexible, soft, good sliding properties	Protective cap	no
K11	ABS	ACRYLONITRILE BUTADIENE STYRENE	-30°C to 80°C	very hard even at low temperatures, scratch resistant hard	Mounting plate, to form part of the plastic ducts	low
K12	ASA	ACRYLONITRILE STYRENE ACRYLATE	-30°C to 85°C	shockproof cold holding equivalent to the ABS	Box reserves	low
K13	PC/ABS	POLYCARBONATE/ACRYLONITRILE BUTADIENE STYRENE	-30°C to 90°C	high impact and notched impact strength, good heat defl ection	NX-Office	low
K14	POM	POLYOXYMETHYLENE	-40°C to 100°C	high shear stability and shock, good heat resistance	A fi xing clip	poor
K15	SBR	STYRENE BUTADIENE RUBBER	-50°C to 100°C	hard, thick, compact, even at high temperatures, good elastic behavior	Toric seal	no
K16	CR/NBR	CHLOROPRENE RUBBER/ NITRILE BUTADIENE RUBBER	-20°C to 100°C	good wear resistance, good resistance to cold and hot temperatures	Toric seal	no
K17	CR/SBR	CHLOROPRENE RUBBER/STYRENE BUTADIENE RUBBER	-20°C to 70°C	good elasticity, impact resistance to improved weather	Toric seal	no
K18	TPE	THERMOPLASTIC ELASTOMER	-40°C to 120°C	good wear resistance, poor resistance to heat and cold	Toric seal	no
K19	FS 31	PHENOLIC RESIN	to 125°C	excellent resistance to weathering, ozone and aging	Versions proposées	low
K20	SI	SILICON RUBBER	-40°C to 180°C	good wear resistance, high hardness, good heat resistance	Toric seal	no
K21	PUR	POLYURETHANE	-25°C to 60°C	good resistance to scratching, to abrasion and torsion	Industrial pipes, glue seal	low
K22	PET	POLYETHYLENE TEREPHTHALATE	-40°C to 190°C	high hardness, low moisture absorption	proposed versions	low
K23	UP-GF	GLASSFIBER RE-INFORCED POLYESTER	-50°C to 80°C	good hardness, good wear resistance and temperature	Cable trays and ladders profile construction, hand rail	low

Resistance to chemicals

Symbol catalog	Water:	Acids (10 %):	Base (10 %):	Alcohol (Ethanol):	Benzine:	Benzol:	Mineral oil:	Vegetable and animal fat:	Chemical products
K01	+	o	+	+	o	+	o	+	o
K02	+	o	+	+	-	-	o	o	+
K03	+	+	+	+	o	-	o	+	-
K04	+	+	+	+	o	o	+	+	o
K05	+	o	-	+	-	-	+	+	o
K06	+	o	o	+	-	-	o	o	o
K07	+	-	-	+	o	+	o	o	o
K08	+	o	+	+	+	o	+	o	o
K09	+	+	+	+	+	-	+	+	-
K10	+	+	o	+	-	N.R.	-	o	-
K11	+	o	N.R.	+	-	-	+	-	-
K12	+	o	o	+	-	-	+	+	-
K13	+	+	+	o	o	-	+	o	-
K14	+	o	o	+	+	+	+	+	-
K15	+	+	+	+	-	-	-	-	o
K16	+	o	o	+	o	-	+	+	o
K17	+	o	o	N.R.	-	-	o	N.R.	N.R.
K18	+	+	+	N.R.	+	N.R.	+	N.R.	-
K19	+	o	o	+	+	o	+	N.R.	o
K20	+	o	o	+	o	-	+	+	o
K21	+	-	-	N.R.	+	N.R.	+	+	o
K22	+	+	o	+	+	o	+	N.R.	o
K23	+	+	+	+	+	o	+	+	+

+ = good performance o = medium performance - = low performance N.R. = no result

References: Table of contents, eg manual Plastic Author: Franck, Publisher: Vogel-Buchverlag

The data in the table are approximate values for product selection and are based on known results to date.

The qualities can negatively change depending on the geometry and external conditions.

Detailed data will be submitted with the offer price. To check the resistance of a product must achieve a specific test in the outdoor environment.

INFORMATION

Polyester resin 0% hologen

Properties	Standard references and Standard designations	Country of origin (Lab)	PRESS type resin R96 Tests Output	PULTRUSION type resin R6204 Tests Output	Units
Fire behavior					
Inflammability	ASTM D 6194 / IEC 60695-2-12 Glow wire test	USA / International (CREPIM, Bruay)	960	960	°C
Inflammability	UL 94 Test for flammability of plastic materials	USA (LNE)	V0	V0	-
Fire propagation	NF P 92-507 Fire behavior of building materials	France	not tested	not tested	-
Flame Spread & Smoke Developed Index	ASTM E84 / UL 723 Surface burning characteristics of building Uniforme Building Code class (SDI max = 450)	USA (Underwriters Lab.)	FSI = 25 SDI = 350 Class I	FSI = 35 SDI = 450 Class II	Index Index -
Spread of Flame	BS 476 Part 7 Surface spread of flame test for materials	England (Uni. Gent)	Class 2	Class 2	-
Fire propagation	BS 476 Part 6 Fire propagation test for materials	England (WFR)	18,3	14,1	Index
Flammability & Smoke Index	NF F 16-101 Fire behavior of materials for rolling stock	France (CREPIM, Bruay)	I2 F0	I2 F1	Index Index
Smoke Developed Index	BS 6853 App B52 Fire precautions in the design and construction of rolling stock	England (WFR)	Ao(on max) = 10,47 Ao(on end) = 9,89 Ao(off) = 11,23	Ao(on max) = 17,34 Ao(on end) = 14,79 Ao(off) = 18,75	Index Index Index
Limiting Oxygen Index	ASTM D 2863 / ISO 4589-2 Results of the fire resistance according to the oxygen index	USA / International (CREPIM, Bruay)	> 32%	> 32%	%
Fire protection Index	VKF Association of cantonal fire assurances	Switzerland (Swissi Basel)	5.3	5.3	Index
Fire Standard	DIN 4102 (Not operational as per 12: Fire resistance of materials and parts, class level)	Germany (FMPA, Stuttgart)	B2 Classe d'indice	B2 Classe d'indice	
Fire Standard	DIN 5510-2 Preventive Fire Protection in railway vehicles Part 2: Fire behaviour and fire side effects of materials and parts Appendix C: FED (30 min) < 1	Germany (RST, Henningsdorf)	S4/SR2/ST2 FED(30 min) = 0,13	S4/SR2/ST2 FED(30 min) = 0,03	Index Index

Mechanical behavior					
Tensile Strength at break point	ISO 527-5	International (Serma Technologies)	~ 55	~ 187	MPa
Modulus of Elasticity	ISO 527-5	International (Serma Technologies)	~ 7200	~ 11900	MPa
Accelerated Ageing Test exposure	ISO 4892-2 / ISO 527-5 Mechanical and UV resistance	International (Serma Technologies)	Good mechanical and chromatic behaviour	Good mechanical and chromatic behaviour	-
Accelerated Ageing Test by salt spray exposure	ISO 9227 / ISO 527-5 Mechanical and salt spray resistance	International (Serma Technologies)	Good mechanical and chromatic behaviour	Good mechanical and chromatic behaviour	-
Accelerated Ageing Test by UV and salt spray exposure	ISO 4892-2 / ISO 9227 / ISO 527-5 Mechanical, UV and salt spray resistance	International (Serma Technologies)	Good mechanical and chromatic behaviour	Good mechanical and chromatic behaviour	-

Properties	Standard references and Standard designations	Country of origin (Lab)	PRESS type resin R96 Tests Output	PULTRUSION type resin R6204 Tests Output	Units
Electrical behavior					
Surface Resistivity & Measure of the discharge from a charged surface	IEC 60079-0 : Suitable with gas groups	International (LCIE)	~ 4.10 ⁹ IIA, IIB, IIC	> 10 ¹¹ IIA, IIB, IIC	Ω -
Breakage Voltage	IEC 60243-1 :	International (IPH)	> 15	non-tester	kV/mm
Comparative tracking index	IEC 60112 :	International (LCIE)	575	600	V

Passenger ship					
Acceptance in passenger ship	ABS	(ABS)	approuvé K ²	approuvé KP - UL	

Others					
Density			1,8	1,8	g/cm ³
Thermal conductivity			0,3	0,3	W/m.K
Linear Thermal Dilatation	DIN 53752 - Détermination du coefficient de dilatation thermique	Germany	~ 36 x 10 ⁻⁶	~ 8 x 10 ⁻⁶	cm/cm/K
Water Absorption	ISO 62 Determination of water absorption	Germany	0,16	0,3	%

Press resin applies for the K2 (previously called KK) and BK range

Pultruded resin applies for the KP and UL ranges.

Conformity according EN 61537 / IEC 61537:

Impact test: K², KP, UL, ML series have successfully passed the shock test with an energy of 20 J (Degree of protection: IK10)

Flame propagation test: K², KP, UL, ML series are non-flame propagating.

CE marking: Our products comply with the directive BT/73/23/CEE according to the harmonized standard EN 61537 : 2001

Galvanized steel - the perfect material

Steel

the material with the many positive characteristics: non-flammable, high mechanical resilient, magnetized, shielding effect (Faraday), no static electricity, fire load-free, halogen-free, 100% fully recyclable.

This exceptionally good, constructive, technological, mechanical and physical properties contribute towards the high utility value and quality of the produced Niedax of cable laying systems.

The many benefits precludes a weak point: steel can rust.

With a well-conducted galvanizing However, this weakness is effectively and cost to overcome. Steel and zinc complement each other perfectly.



Good all-round protection

is due to the formation of protective, adherent coatings on the zinc. On the new products initially forms a zinc oxide film, which is converted to zinc hydroxide or zinc carbonate under the influence of humidity and carbon dioxide (zinc patina). These protective layers are formed, depending on the surrounding atmosphere, in a few days to several weeks.

Cathodic protection

or surface protection mean refers to the ability of zinc to protect the cutting surfaces or other surface damage upon exposure to moisture to corrosion. This capability is based on the more negative of the zinc compared to zinc in the iron status of the „electrolytic voltage range“. A galvanizing can not rust for the same reason. The cut surface protection is effective up to a material thickness of 2 mm.

Adequate ventilation galvanized components is mandatory. Under unfavorable storage and transport conditions (humid conditions, little or no airflow) may form on freshly galvanized surfaces known as white rust (loose porous zinc hydroxide). White stains may also appear by a dry storage and an insufficient air access to all surfaces (possibly with stacking wood shims use). Outdoor storage under sheets or tarpaulins should be avoided.

Niedax cable laying systems made of steel are generally used only in a galvanized finish.*) This term corrosion protection saves valuable natural resources and is thus a significant contribution to environmental protection. As corrosion protection for the Niedax cable laying systems come, operational and manufacturing reasons, the galvanizing process described in more detail in the following summaries are used.

*) For exceptional, aggressive environmental conditions cable laying systems are made of stainless steel or fiberglass reinforced Plastic available.

Galvanizing Processes

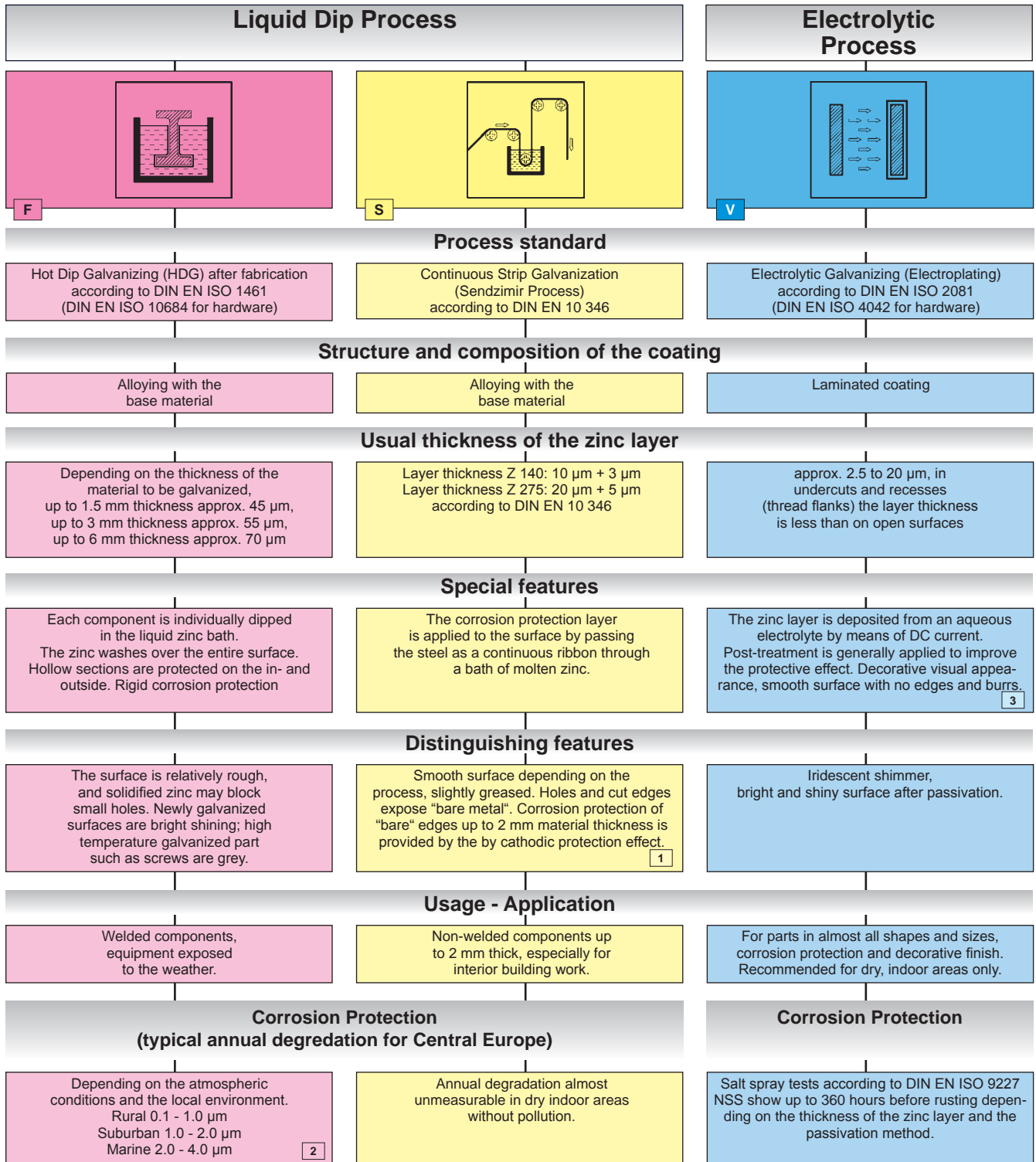

1 Components over 2 mm in material thickness are hot dip galvanized at Niedax

2 Local environmental conditions would be for instance the direct corrosive effect of a chimney with CO₂ flue gases.

3 Chromating process is ROHS compliant.

Galvanizing

Batch galvanizing F

(Hot-dip galvanisation) according to DIN EN ISO 1461 (DIN EN ISO 10684 for hardware)



By immersion in liquid zinc (hot-dip process, ca. 450° C), the entire surface, including all corners and edges lapped. On the steel is an iron-zinc alloy layer forms with an overlying layer of pure zinc. The layer thickness depends on the material thickness and is according to DIN EN ISO 1461 to 1.5 mm material thickness 45 microns, up to 3 mm thick 55 microns and up to 60 mm material thickness 70 microns. Due to the very hard iron-zinc alloy layer can batch-galvanized components, without damaging the zinc surface, not deformed.

Application examples from the Niedax program:

All components with welded joints, for example, suspension struts, cable and pipe clamps as well as products with more than 3 mm thick, cable trays / ladders, wide span cable trays / ladders and many more, as far as increased demands on the corrosion resistance (weathering without rain shield).

Strip coating S

(Sendzimir Process) according to DIN EN 10346

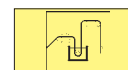

The zinc coating is on both sides, applied by a zinc bath on broadband in the run. The project uses the modified Sendzimir. On the steel is an iron-zinc alloy layer forms with an overlying layer of pure zinc. The layer thickness of the Sendzimirbandes used for Niedax cable laying systems is under consideration of the test method according to DIN EN 10346 according to three surface sample depending on the product group 10 - 20 microns.

Strip galvanisation is used for components up to max. 2 mm material thickness, as up to this strength, a sufficient edge protection is achieved by „cathodic protection“. The process-related „bare iron“ interfaces of the components are in use in dry interiors, by the cathodic protection effect is not a disadvantage. Strip galvanized components can be formed without damaging the zinc surface.

Application examples from the Niedax program:

Cable trays / ladders, wide span cable trays / ladders, cable ladders, cable protection ducts, light boom, rails up to 2 mm thickness. In dry indoor areas without aggressive media, the strip galvanizing provides permanent corrosion protection.

Zinc coating V G

Selon DIN EN ISO 2081 (DIN EN ISO 4042 for hardware)

The zinc coating is applied in aqueous electrolytes by means of direct current. To improve the corrosion protection can be carried out by an aftertreatment thick layer passivation and blue passivation according to DIN 50961.

The zinc coating is 2.5 to 20 microns. Parts with undercuts, such as C-shaped armature rails, due to the process less heavily coated inside than outside (Faraday cage).



Application examples from the Niedax program:

Small parts (screws, washers up to max. 6 M), mounting rails and screws for distribution board, but with additional thick layer passivated.

Additional plastic coating **C1** Hot Dip Galvanizing components with a polyester epoxy resin coating

The products marked with C1 are hot-dip galvanized and polyester resin with an epoxy coating in a thickness of 60 - 80 microns provided. When using indoors this plastic coating ensures excellent corrosion protection as well as high mechanical resistance and is resistant to most chemicals.

The zinc coating is thus protected by the overlying coating from atmospheric and chemical influence. A removal of metallic zinc is avoided, so that the zinc coating remains intact for a long time under the coating in mint condition.

For special use in the outdoor area, we are pleased to offer other coatings

Coat with zinc dust paint



The zinc-rich paint shall be such that in the dry film more than 90% zinc is included. To avoid the formation of cracks in the coating, the coating is applied in several steps.

Application examples in connection with the Niedax program:

Improvements, particularly assembly-related injuries of the zinc surface by welds or the like.

INTERNATIONAL SALES AGENCIES

Australia

Niedax Australia Pty. Ltd. Level 28, 1 Market Street
Sydney, NSW 2000
Mr. Chris Ivkovic . Tel: +61 488 222 310
chris.ivkovic@niedax.com.au
info@niedax.com.au . www.niedax.com.au

Brazil

Niedax Participações Societárias Ltda.
Rua Verbo Divino, 1661
BR-04719-908 São Paulo
Tel: +55 19 38782566 . Fax: +55 19 38782566
lutz.vosgerau@niedax.de

Croatia

RS Kabel d.o.o.
Savska cesta 41/VI, Poslovni To
10144 Zagreb
Tel: +385 1 611 2038 . Tel: +385 1 631 3239
prodaja@rs-kabel.hr . www.rs-kabel.hr

Estonia

Poweram Elektriseadmed OÜ
Lohu 12, 12618 Tallinn
Tel: +372 672 6833 . Fax: +372 672 6831
info@poweram.ee . www.poweram.ee

France

Niedax France
Parc d'Activités Washington
Av. de la ferme du Roy, FR-62404 Béthune Cedex
Tel: +33 321 64 75 75 . Fax: +33 321 64 75 76
info@niedax.fr . www.niedax-group.com

India

Niedax Cable Management Systems Pvt. Ltd.
1007, Prestige Meridian I, 29 Mahatma Gandhi Road
Bangalore - 560 001
info@niedax.co.in . www.niedax.co.in

Italy

Niedax EBO Italia S.R.L.
Con Socio Unico, Via Roma, 118
I-20040 Cavenago di Brianza (MB)
Tel: +39 0295339124 . Fax: +39 0270057923
info.it@ebo-systems.com . www.niedax.com

Lithuania

JSC „Swelbalt“
Sudmantu kaimas
92498 Klaipėdos rajonas
Tel: +370-46-300 100 . Fax: +370-46-300 101
info@swelbalt.lt . www.swelbalt.lt

Netherlands

Niedax-Kleinhuis B.V.
Bijsterhuizen 21-03; NL-6604 LE Wijchen
Postbus 6694; NL-6503 GD Nijmegen
Tel: +31 243788533 . Fax: +31 243788390
info@niedax.nl . www.niedax.nl

Peru/Equador/Bolivia

Kombau Peru S.A.C.
Av/Larco 1116 Int. C
Miraflores Lima
Tel: +51 968134880 . Fax: +51 968134880
info@kombau.net . www.kombau.net

Romania

Niedax Romania s.r.l.
Soseana Chitilei nr. 3, sector 1
RO-012381 Bucuresti
Tel: +40 216680280 . Fax: +40 216680280
info@niedax.ro . www.niedax-group.com

Singapore

Niedax Asia Pacific Pte. Ltd.
21 Bukit Batok Crescent, WCEGA Tower, Unit 16 - 70
Singapore 658085
niedaxgroup@niedax.com.sg
www.niedax-group.com

Spain

Niedax-Kleinhuis Ibérica S.L.U.
C/Italia 5 y 7
E-28971 Grinón (Madrid)
Tel: +34 918103197 . Fax: +34 918103889
niedax.iberica@niedax.com . www.niedax.com

Thailand

Niedax (Thailand) Ltd.
62/10 M6, T Samnaktorn, A. Ban Chang
Rayong 21130 Thailand
Tel: +66 (38) 963 258 . Fax: +66 (38) 963 595
info@niedax.co.th

Austria

Niedax Kabelverlege-Systeme GmbH
Resselstraße 10
A-2120 Walkersdorf
Tel: +43 2245901100 . Fax: +43 22459011020
office@niedax.at . www.niedax.at

Brunei

Joffren Omar Company Sendirian Berhad
Head Office Setia Lot 49-51
Sg. Bera Light Industrial Area Setia
KB1933, Negara Brunei Darussalam
Tel: +673 3223 863 . Fax: +673 3223 309

Czech Republic

Niedax-Kleinhuis s.r.o.
Palackeho 701
CZ-27746 Veltrusy
Tel: +42 0315781116 . Fax: +42 0315781118
niedax@seznam.cz

Finland

Apstek Oy
Aleksanterinkatu 15B
FIN-00100 Helsinki
Tel: +358 40 9006226
jukka@apstek.com

GCC States

Niedax Middle East FZE
P.O. Box 262461
FZS2AC08, Jebel Ali, UAE-Dubai
Tel: +9714 880 7970 . Fax: +9714 880 7972
ibrahima@ebo-systems.com . www.niedax.com

Indonesia

Jakarta
Niedax Asia Pacific Pte. Ltd
Mr. Raharjo Wicaksono
Tel: +62 816 171 696 08
raharjo.wicaksono@niedax.com

Korea

Hansung System
RM # 301 Nexvill, 1301-2, Baekseok-Dong, Ilsan-
dong-Gu, Goyang-Si, Kyunggi-Do, Korea, 410-817
Tel: +82 31 908 3912
hantradr@unitel.co.kr

Luxembourg

Minusines S.A.
B.P. 2212; 8, rue Hogenberg
L-1022 Luxembourg-Gasperich
Tel: +352 495858 . Fax: +352 495866
info@minusines.lu . www.minusines.lu

Norway

Eaton Electric AS
Prost Stabels vei 22, N-2019 Skedsmokorset
P.O. Box 244, N-2021 Skedsmokorset
Tel: +47 63870200 . Fax: +47 63870201
firmapost-nor@eaton.com . www.moeller.no

Philippines

POWEREDGE™ Solutions Phils Inc
285-A Haig St Brgy Daang Bakal
Mandaluyong City 1552
Office: (02) 5355552-53
www.poweredge.com.ph

Russia

Niedax OOO
Leningradsky Prospekt 7/3
125315 Moskau
Tel: +7 499 654 02 32 . Fax: +7 499 654 02 33
russia@ctssas.com

Slovak Republic

Niedax Slovakia s.r.o.
Pestovateľská 6
SK-82104 Bratislava
Tel: +421 244630934 . Fax: +421 244630935
niedax@niedax.sk . www.niedax.sk

Sweden

Fasteus Teknik AB
Magasinsgatan 35
S-43437 Kungsbacka
Tel: +46 30051000 . Fax: +46 30070410
info@fasteus.se . www.fasteus.se

USA

Niedax Inc.
2970 Charter Street
Columbus, OH 43228 USA
Tel: +1 6149218469 . Fax: +1 6149218676
sales@niedaxusa.com . www.niedaxusa.com

Belgium

Niedax-Kleinhuis N.V.
Tulpenstraat 2
B-9810 Eke/Nazareth
Tel: +32 92200790 . Fax: +32 92200791
info@niedax.be

Bulgaria

Niedax Bulgaria
Filip-Kutev-Str. 137
BG-1407 Sofia
Tel: +359 29624574 . Fax: +359 29624504
office@niedax.bg

Denmark

Duelco A/S
Systemvej 8-10
DK-9200 Aalborg SV
Tel: +45 70101007 . Fax: +45 70101008
info@duelco.dk . www.duelco.dk

France

Ebo Systems S.A.S.
Zone Industrielle, Avenue Jean Monnet, BP 5
F-54920 Villers-la-Montagne
Tel: +33 382440107 . Fax: +33 382261041
info@ebo-systems.com . www.ebo-systems.com

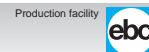

Hungary

Niedax Kereskedelmi Kft.
Budafoki út 10.
H-2030 Érd
Tel: +36 23521300 . Fax: +36 23390489
info@niedax.hu . www.niedax-group.com

Ireland/UK

Niedax CMS Ltd.
Clash Industrial Estate
IRL-Tralea, Co. Kerry, Ireland
Tel: +353 667128701 . Fax: +353 667180301
matt@niedax.ie . www.niedax-group.com

Latvia

AS ERNERGOFIRMA JAUDA
Krustpils street 119
LV-1057 Riga, LATVIA
Tel: +37 67725789 . Fax: +37 67725770
info@jauda.com . www.jauda.com

Mexico

Niedax de Mexico S.A. de C.V.
Priv. Lomas de la Carcana 10 A
J.A. Santiago Momoxpan
C.P. 72760 San Pedro Cholula, Mexico
Tel: +1 6149218469 . Fax: +1 6149218676
salesmex@niedax.com

Pakistan

Industrial Supplies & Engineering Associates
PO BOX 8103 Baghbanpura Lahore-9,
P.O. Code: 54920
Tel: +92 3444465812
isea_global@yahoo.com . isea.global1@gmail.com

Poland

Niedax-Kleinhuis Polska Sp.zo.o.
ul. Zagórska 133
PL-42-680 Tarnowskie Góry
Tel: +48 323819810 . Fax: +48 323843956
info@niedax.pl . www.niedax.pl

Serbia

GEMEX d.o.o
Zrenjanski put 103b
11210 Belgrad
Tel: +381 11 33181 . Fax: +381 11 3318012
zoran.brasanac@gemex.rs

Slovenia

Kabeltrade d.d.o.
Latkova vas 83B, 3312 Prebodd
Tel: +386 3 620 24 62
kabeltrade@kabeltrade.si
www.kabeltrade.si

Switzerland

Niedax EBO Schweiz AG
Wehreyering 21 Postfach
CH-3930 Visp
Tel: +41 279456868 . Fax: +41 279456869
info@niedax.ch

Vietnam

Niedax Asia Pacific Pte. Ltd
Ho Chi Minh City
nam.dang@niedax.com

Sales conditions

1. Opposability

These sales conditions are sent with our bid to all purchasers to raise an order. Consequently, raising an order implies full, unreserved acceptance of these conditions, excluding any other type of document such as a brochure or catalogue, which only give approximate information. No special condition can have priority over these conditions, except if formal written approval is received from Ebo Systems. Furthermore, the purchaser renounces his own general purchasing conditions. The fact that Ebo Systems does not invoke, at a given moment, one of the present conditions, cannot be interpreted as being a renunciation of future invocations of such a condition.

2. Contract validity

Bids by Ebo Systems are only valid for a duration of 2 (two) months unless specified otherwise. Orders are only definitively accepted when they have been confirmed in writing by Ebo Systems and where applicable, after payment of the agreed advance. The fact that the purchaser does not reply within 8 (eight) days following the sending of written conformation, is equal to express acceptance by the purchaser. Should an order that has become definitive be cancelled, the entire purchase price will be invoiced to the purchaser and become immediately payable. Ebo Systems none the less reserves the right, in case of a drop in the credit rating of the purchaser, or if Ebo Systems has legitimate reason to consider that the purchaser will be incapable of paying the purchase price at the agreed deadlines:

- either to cancel an order in progress, even if definitive
 - or to demand first rate guarantees, or a payment before delivery, it being understood that payment means effective cashing of the payment instrument.
- The order is specifically intended for the purchaser and cannot be transferred without prior written approval from Ebo Systems.

3. Object of the delivery

Ebo Systems reserves the right to make any change to the presentation, shape, size and design at any time it considers useful to its products without being obliged to modify ordered goods being manufactured. Ebo Systems also reserves the right to modify, without prior warning, the products defined in its pamphlets and catalogues. None the less, in case of changes to standards or improvements to products ordered before delivery Ebo Systems reserves the right to make the technical changes necessary without the object ordered being modified.

4. Shipment

Any increase to cost of shipment, to taxes or miscellaneous duties occurring during performance of the contract is entirely paid by the purchaser except if there are special or contrary provisions in the price legislation. Special packaging, maritime freight or insurance where applicable, shall be invoiced at the tariff in force at the moment of shipment.

5. Delivery turnaround times

5.1 Delivery turnaround times are given for information purposes and are not guaranteed. Ebo Systems is authorized to make global or partial deliveries. Overshooting of delivery times cannot give rise to compensation and interest, nor discounts or cancellations of orders, unless contrary provisions are agreed in writing with the purchaser. Ebo Systems may be released from its commitment to deliver in case of *force majeure*. Without this list being comprehensive, *force majeure* includes: war, uprisings, strikes or combined action by the personnel of the suppliers of Ebo Systems or service suppliers Ebo Systems uses to carry out orders.

5.2 In all cases, delivery within the agreed turnaround times can only take place if the purchaser has fully satisfied all his commitments to Ebo Systems, no matter what the reason, especially those resulting from article 2 of these conditions.

6. Delivery costs and risks

Goods are delivered in compliance with Incoterms I.C.C. dated January 2000. As of the delivery, as defined in Article 4 of these conditions, the goods travel at the expense and risk of the purchaser, who is responsible in case of damage or missing articles to make any necessary reservations and to take all steps to preserve his rights of action against the shipper. The shipper designated by Ebo Systems, works on the behalf of, at the expense of and risk of the purchaser. Unless prior written instructions are received from the purchaser, repeated for each shipment and reception confirmed by Ebo Systems, Ebo Systems is not bound to take out any insurance, declaration of value or make any declaration of interest at delivery on behalf of the purchaser, no matter what might be the value of the goods shipped. The costs relating to the services undertaken by Ebo Systems on behalf of the purchaser are fully invoiced to the purchaser. In no case whatsoever can Ebo Systems be held responsible for the method of payment selected and the tariff applied by the shipper.

7. Reception

Notwithstanding any prejudice to the measures to take with regard to the shipper, claims for missing articles, visible defects or non-compliance of goods delivered with regard to goods ordered or the bill of lading, must be made in writing and sent by registered letter with acknowledgement, within 8 (eight) days following delivery of such goods. Beyond this period of time, no claim will be accepted. The purchaser shall leave Ebo Systems leeway to confirm these faults and to remedy them. The purchaser promises not to take any action himself, nor bring in a third party for this purpose.

8. Return of products

No return of products shall be carried out without prior written authorization from Ebo Systems. The cost and risk of return of products is always at the expense of the purchaser. In case of visible defects or the non-conformity of delivered goods, duly recorded by Ebo systems under the condition scheduled in Article 7 of these conditions, the purchaser may obtain reimbursement of the price paid, excluding any indemnity and compensation. On the other hand, if the claims made by the purchaser are not substantiated, Ebo Systems has the right to invoice him for all non-substantiated travel, goods inspection and transport expenses.

9. Guarantee

Ebo Systems are ISO 9001 certified. Products are guaranteed against any functional fault for a duration of 6 (six) months as of the date of delivery. Under this guarantee, the only commitment encumbering Ebo Systems will be the reimbursement of the purchase price, excluding any compensation, no matter what it might be. In no case whatsoever can the liability of Ebo Systems exceed the price of the products. To be taken into account, any defective product under guaranteed must be returned at the expense and risk of the purchaser with a return note, once accepted by Ebo Systems.

10. Guarantee exclusions

Any demand with an aim to implementing the guarantee can only be accepted if the purchaser is up to date with his financial commitments with regard to Ebo Systems. Defects and damage caused by normal wear, accidental causes, negligence, malicious intent, implementation not in compliance with good works practice, protection and safety standards, regulations in force, repair by third parties or even defective maintenance shall be excluded from the guarantee.

11. Price

Products are provided at the price rate in force on the date of the order. Prices are net, ex plant, special packaging in addition.

12. Payment methods

Invoices are payable cash on reception, by check, signed and accepted letter of credit, protest not being necessary or any other accepted method of payment. In case of payment by letters of credit, the purchaser is bound to return the letters accepted and signed within a maximum of 7 (seven) days. Payment according to these general sales conditions is not simply the fact of paying by check or by letter of credit, but its effective cashing at the scheduled date. Any drop to the purchaser credit rating may substantiate the demand for first rate guarantees or cash payment when ordering or payment by sight draft prior to execution of orders received or before the due date of issued invoices. Ebo Systems reserves the right at all times, according to the risks involved, to set a maximum credit allowance for each purchaser, it being understood that these modalities are valid for all orders in progress. The refusal by the purchaser to meet these conditions gives Ebo Systems the right either to cancel all or part of the orders or to demand immediate payment of all sums due.

13. Late payment or failure to pay

In case of late payment, Ebo Systems may suspend all orders in progress without any prejudice to any other means of action. Any sum not paid at the scheduled payment time will give rise by full right and without any prior warning, to payment of late payment interest at a rate equal to one and a half times the legal interest rate in force in France, from the due date up to the payment date. In case of failure to pay forty-eight hours after formal notice without response, the sale shall be cancelled by full right if considered necessary by Ebo Systems, who can request restitution of products, without prejudice for other compensation. The resolution will not simply affect the order involved but also all previous orders whether delivered or being delivered and related payment, whether due or not. In case of payment by letter of credit, the returned letter shall be considered as a refusal to accept, assimilated to a failure to pay. Non-payment of a single invoice or at a payment date will result in the immediate payment of all sums due without other warnings. In all preceding cases, the sums due for other reasons or any other cause become immediately payable if Ebo Systems does not opt for the resolution of the corresponding orders. The purchaser shall reimburse, other than the principle and the interest, all expenses caused by the recovery by litigation of sums due, as well as a 15% (fifteen percent) penalty of the unpaid sum. In no case may payments be suspended or be the subject of any compensation without prior written approval from Ebo Systems. All partial payments shall first used to pay compensation and penalties, then the sums with the oldest due payment date. No failure to pay, or late payment, can be justified later by a claim. Lastly, reference to the stipulations made in Article 2 of these general sales conditions is made.

14. Transfer of risks

Transfer of risks takes place as of the moment the goods are made available to the purchaser at a location agreed upon with Ebo Systems at the date, or within the stipulated time frame, or as of the moment such goods have been delivered to the terminal of the forwarder, agreed with the purchaser. As of this moment, the goods are shipped at the risk and the expense of the purchaser.

15. Right of ownership

Ebo Systems reserves the ownership of delivered goods until the full payment of the sum due by the purchaser is received. The purchaser is bound to keep goods in perfect condition and to insure goods on behalf of the owner against all usual risks, especially loss, destruction or theft, with the indemnity being delegated in case of a problem to Ebo Systems. Ebo Systems must immediately be informed about any accident. The purchaser promises to immediately inform Ebo Systems in the case of settlement or judicial winding-up, in case of seizure or any other procedure initiated by a third party and to inform Ebo Systems of the exact location where delivered goods not yet paid for are stored. The purchaser promises not to use delivered unpaid for goods as security and in general not to carry out any operation likely to cause prejudice to the right of ownership of Ebo Systems. In case of resale of delivered goods, whether or not the purchaser is authorized, the purchaser declares now to declare to Ebo Systems the debt resulting from the sale to a sub-purchaser and authorizes Ebo Systems to cash the price paid by the sub-purchaser, up to the total sum of his debt with the purchaser. The purchaser promises to inform Ebo Systems immediately of the exact and complete identity of any sub-purchaser, who will be informed by the purchaser of the right of ownership by Ebo Systems, at the latest at the moment of signing the contract. Any violation by the purchaser with regard to the obligations stipulated in this clause or in the general sales conditions shall be sanctioned by full rights by the event of default. The claim by Ebo Systems to the goods of which the ownership is reserved is by means of registered letter with acknowledgement, sent to the purchaser, requiring him to return the goods in his possession to Ebo Systems. The claim of goods under reserve of ownership neither constitutes a resolution nor cancellation to the sales contract. The claim may be made by Ebo Systems in case of non-observance of any of the commitments by the purchaser, especially non-acceptance of a letter of credit, in which case Ebo Systems will have all legal rights to think that the purchaser is not capable of observing the agreed payment dates. All expenses caused by the claiming of goods or their corresponding sum are at the exclusive cost of the purchaser.

16. Court of competent jurisdiction and applicable law

The court of competent jurisdiction is expressly allocated to the courts of BRIEY - France, who will decide on the application of French law unless Ebo Systems decides to nominate another court of competent jurisdiction.



NIEDAX GROUP



Ebo Systems

Ebo Systems S.A.S.
Zone Industrielle BP 5
F-54920 Villers-la-Montagne

Tel: +33 382440107
Fax: +33 382261041

info@ebo-systems.com
www.ebo-systems.com